

SHARP[®]

PN-L803C

LCD MONITOR

OPERATION MANUAL

HDMI

IMPORTANT:

To aid reporting in case of loss or theft, please record the product's model and serial numbers in the space provided. The numbers are located in the rear of the product.



Model No.:

Serial No.:

U.S.A. ONLY

IMPORTANT INFORMATION

WARNING: TO REDUCE THE RISK OF FIRE OR ELECTRIC SHOCK, DO NOT EXPOSE THIS PRODUCT TO RAIN OR MOISTURE.

	CAUTION RISK OF ELECTRIC SHOCK DO NOT OPEN	
CAUTION: TO REDUCE THE RISK OF ELECTRIC SHOCK, DO NOT REMOVE COVER. NO USER-SERVICEABLE PARTS INSIDE. REFER SERVICING TO QUALIFIED SERVICE PERSONNEL.		



The lightning flash with arrowhead symbol, within a triangle, is intended to alert the user to the presence of uninsulated “dangerous voltage” within the product’s enclosure that may be of sufficient magnitude to constitute a risk of electric shock to persons.



The exclamation point within a triangle is intended to alert the user to the presence of important operating and maintenance (servicing) instructions in the literature accompanying the product.

WARNING:

FCC Regulations state that any unauthorized changes or modifications to this equipment not expressly approved by the manufacturer could void the user’s authority to operate this equipment.

NOTE:

This equipment has been tested and found to comply with the limits for Class A digital device, pursuant to Part 15 of the FCC Rules. These limits are designed to provide reasonable protection against harmful interference when the equipment is operated in a commercial environment. This equipment generates, uses, and can radiate radio frequency energy and, if not installed and used in accordance with the instruction manual, may cause harmful interference to radio communications. Operation of this equipment in a residential area is likely to cause harmful interference in which case the user will be required to correct the interference at his own expense.

This product utilizes a CR coin Lithium battery which contains a Perchlorate material. Special handling for this material may apply, California residents, See www.dtsc.ca.gov/hazardouswaste/perchlorate/ Others, consult local environmental officers.

U.S.A. ONLY

DEAR SHARP CUSTOMER

Thank you for your purchase of a SHARP LCD product. To ensure safety and many years of trouble-free operation of your product, please read the Safety Precautions carefully before using this product.

SAFETY PRECAUTIONS

Electricity is used to perform many useful functions, but it can also cause personal injuries and property damage if improperly handled. This product has been engineered and manufactured with the highest priority on safety. However, improper use can result in electric shock and/or fire. In order to prevent potential danger, please observe the following instructions when installing, operating and cleaning the product. To ensure your safety and prolong the service life of your LCD product, please read the following precautions carefully before using the product.

1. Read instructions — All operating instructions must be read and understood before the product is operated.
2. Keep this manual in a safe place — These safety and operating instructions must be kept in a safe place for future reference.
3. Observe warnings — All warnings on the product and in the instructions must be observed closely.
4. Follow instructions — All operating instructions must be followed.
5. Cleaning — Unplug the power cord from the AC outlet before cleaning the product. Use a dry cloth to clean the product. Do not use liquid cleaners or aerosol cleaners. Do not use dirty cloths. Doing so may damage the product.
6. Attachments — Do not use attachments not recommended by the manufacturer. Use of inadequate attachments can result in accidents.
7. Water and moisture — Do not use the product near water. Do not install the product in a place where water may splash onto it. Be careful of equipment which drains water such as an air-conditioner.
8. Ventilation — The vents and other openings in the cabinet are designed for ventilation. Do not cover or block these vents and openings since insufficient ventilation can cause overheating and/or shorten the life of the product. Do not place the product on a sofa, rug or other similar surface, since they can block ventilation openings. Do not place the product in an enclosed place such as a bookcase or rack, unless proper ventilation is provided or the manufacturer's instructions are followed.
9. Power cord protection — The power cords must be routed properly to prevent people from stepping on them or objects from resting on them.
10. The screen used in this product is made of glass. Therefore, it can break when the product is dropped or applied with impact. Be careful not to be injured by broken glass pieces in case the screen breaks.
11. Overloading — Do not overload AC outlets or extension cords. Overloading can cause fire or electric shock.
12. Entering of objects and liquids — Never insert an object into the product through vents or openings. High voltage flows in the product, and inserting an object can cause electric shock and/or short internal parts. For the same reason, do not spill water or liquid on the product.
13. Servicing — Do not attempt to service the product yourself. Removing covers can expose you to high voltage and other dangerous conditions. Request a qualified service person to perform servicing.
14. Repair — If any of the following conditions occurs, unplug the power cord from the AC outlet, and request a qualified service person to perform repairs.
 - a. When the power cord or plug is damaged.
 - b. When a liquid was spilled on the product or when objects have fallen into the product.
 - c. When the product has been exposed to rain or water.
 - d. When the product does not operate properly as described in the operating instructions.

Do not touch the controls other than those described in the operating instructions. Improper adjustment of controls not described in the instructions can cause damage, which often requires extensive adjustment work by a qualified technician.
 - e. When the product has been dropped or damaged.
 - f. When the product displays an abnormal condition. Any noticeable abnormality in the product indicates that the product needs servicing.
15. Replacement parts — In case the product needs replacement parts, make sure that the service person uses replacement parts specified by the manufacturer, or those with the same characteristics and performance as the original parts. Use of unauthorized parts can result in fire, electric shock and/or other danger.
16. Safety checks — Upon completion of service or repair work, request the service technician to perform safety checks to ensure that the product is in proper operating condition.
17. Wall mounting — When mounting the product on a wall, be sure to install the product according to the method recommended by the manufacturer.
18. Heat sources — Keep the product away from heat sources such as radiators, heaters, stoves and other heat-generating products (including amplifiers).

SAFETY PRECAUTIONS (Continued)

19. Batteries — Incorrect use of batteries may cause the batteries to burst or ignite. A leaky battery may corrode the equipment, dirty your hands or spoil your clothing. In order to avoid these problems, make sure to observe the precautions below:
 - Use the specified batteries only.
 - Install the batteries with due attention to the plus (+) and minus (-) sides of the batteries according to the instructions in the compartment.
 - Do not mix old and new batteries.
 - Do not mix batteries of different types. Voltage specifications of batteries of the same shape may vary.
 - Replace an exhausted battery with a new one promptly.
 - If you will not use the remote control for a long time, remove the batteries.
 - If leaked battery fluid gets on your skin or clothing, rinse immediately and thoroughly. If it gets into your eye, bathe your eye well rather than rubbing and seek medical treatment immediately. Leaked battery fluid that gets into your eye or your clothing may cause a skin irritation or damage your eye.
20. Usage of the monitor must not be accompanied by fatal risks or dangers that, could lead directly to death, personal injury, severe physical damage or other loss, including nuclear reaction control in nuclear facility, medical life support system, and missile launch control in a weapon system.
21. Do not stay in contact with the parts of the product that become hot for long periods of time. Doing so may result in low-temperature burns.
22. Do not modify this product.

WARNING:

This is a Class A product. In a domestic environment this product may cause radio interference in which case the user may be required to take adequate measures.

To maintain compliance with EMC regulations, use shielded cables to connect to the following terminals: HDMI input terminal, D-SUB input terminal, DisplayPort input/output terminals and RS-232C input terminal.

If a monitor is not positioned in a sufficiently stable location, it can be potentially hazardous due to falling. Many injuries, particularly to children, can be avoided by taking simple precautions such as:

- Using fixing devices like wall mount brackets recommended by the manufacturer.
- Only using furniture that can safely support the monitor.
- Ensuring the monitor is not overhanging the edge of the supporting furniture.
- Not placing the monitor on tall furniture (for example, cupboards or bookcases) without anchoring both the furniture and the monitor to a suitable support.
- Not standing the monitors on cloth or other materials placed between the monitor and supporting furniture.
- Educating children about the dangers of climbing on furniture to reach the monitor or its controls.

Especially for child safety

- Don't allow children to climb on or play with the monitor.
- Don't place the monitor on furniture that can easily be used as steps, such as a chest of drawers.
- Remember that children can become excited while watching a program, especially on a "larger than life" monitor. Care should be taken to place or install the monitor where it cannot be pushed, pulled over, or knocked down.
- Care should be taken to route all cords and cables connected to the monitor so that they cannot be pulled or grabbed by curious children.

TIPS AND SAFETY INSTRUCTIONS

- The TFT color LCD panel used in this monitor is made with the application of high precision technology. However, there may be minute points on the screen where pixels never light or are permanently lit. Also, if the screen is viewed from an acute angle there may be uneven colors or brightness. Please note that these are not malfunctions but common phenomena of LCDs and will not affect the performance of the monitor.
- Do not display a still picture for a long period, as this could cause a residual image.
- Never rub or tap the monitor with hard objects.
- Please understand that SHARP CORPORATION bears no responsibility for errors made during use by the customer or a third party, nor for any other malfunctions or damage to this product arising during use, except where indemnity liability is recognized under law.
- This monitor and its accessories may be upgraded without advance notice.
- Do not use the monitor where there is a lot of dust, where humidity is high, or where the monitor may come into contact with oil or steam. Do not use in an environment where there are corrosive gases (sulfur dioxide, hydrogen sulfide, nitrogen dioxide, chlorine, ammonia, ozone, etc.). As this could lead to fire.
- Ensure that the monitor does not come into contact with water or other fluids. Ensure that no objects such as paper clips or pins enter the monitor as this could lead to fire or electric shock.
- Do not place the monitor on top of unstable objects or in unsafe places. Do not allow the monitor to receive strong shocks or to strongly vibrate. Causing the monitor to fall or topple over may damage it.
- Do not use the monitor near heating equipment or in places where there is likelihood of high temperature, as this may lead to generation of excessive heat and outbreak of fire.
- Do not use the monitor in places where it may be exposed to direct sunlight. Risk of cabinet deformation and failure if the monitor is used in direct sunlight.
- Images cannot be rotated on this monitor. When using in portrait orientation, you will need to prepare appropriately orientated content in advance.
- The AC outlet shall be installed near the equipment and shall be easily accessible.
- Please be sure to constantly remove dust and garbage that has attached to the ventilation opening. If dust collects in the ventilation opening or the inside of the monitor, it may lead to excessive heat, outbreak of fire, or malfunction. Please request a cleaning of the inside of the monitor from an authorized SHARP servicing dealer or service center.
- Do not touch the screen when the monitor power is turned on, it will lead to a malfunction. When this occurs, turn the monitor power off and then on.
- Do not operate the screen with a hard or pointed object such as a fingernail or pencil.
- Depending on the application used, the touch pen may not function.
- If another USB device is connected to the computer to which the touch panel is connected, do not operate the USB device during touch panel input. Input may not take place correctly.
- Do not allow a cable to come near the screen. This may cause the touch panel to malfunction.

The Power Cord

- Use only the power cord supplied with the monitor.
- Do not damage the power cord nor place heavy objects on it, stretch it or over bend it. Also, do not add extension cords. Damage to the cord may result in fire or electric shock.
- Do not use the power cord with a power tap. Adding an extension cord may lead to fire as a result of overheating.
- Do not remove or insert the power plug with wet hands. Doing so could result in electric shock.
- Unplug the power cord if it is not used for a long time.
- Do not attempt to repair the power cord if it is broken or malfunctioning. Refer the servicing to the service representative.

Manual Scope

- Microsoft, Windows, Internet Explorer, Excel and PowerPoint are either registered trademarks or trademarks of Microsoft Corporation in the United States and/or other countries.
- The terms HDMI and HDMI High-Definition Multimedia Interface, and the HDMI Logo are trademarks or registered trademarks of HDMI Licensing, LLC in the United States and other countries.
- DisplayPort is a registered trademark of Video Electronics Standards Association.
- Adobe, Acrobat, and Reader are either registered trademarks or trademarks of Adobe Systems Incorporated in the United States and/or other countries.
- Intel, Celeron, and Intel Core 2 Duo are trademarks or registered trademarks of Intel Corporation or its subsidiaries in the U.S.A. and other countries.
- AMD, AMD Sempron, AMD Athlon, and combinations thereof are trademarks of Advanced Micro Devices, Inc.
- This product comes with RICOH Bitmap Fonts produced and sold by RICOH COMPANY, LTD.
- All other brand and product names are trademarks or registered trademarks of their respective holders.
- Language of OSD menu used in this manual is English by way of example.
- Illustrations in this manual may not exactly represent the actual product or display.
- This manual assumes use in landscape orientation, except where specifically noted.

LED Backlight

- The LED backlight in this product has a limited lifetime.
 - * If the screen gets dark or does not turn on, it may be necessary to replace the LED backlight.
 - * This LED backlight is exclusive to this product and must be replaced by an authorized SHARP servicing dealer or service center. Please contact an authorized SHARP servicing dealer or service center for assistance.

MOUNTING PRECAUTIONS

- This product is for use indoors.
- A mounting bracket compliant with VESA specifications is required.
- Since the monitor is heavy, consult your dealer before installing, removing or moving the monitor.
- Mounting the monitor on the wall requires special expertise and the work must be performed by an authorized SHARP dealer. You should never attempt to perform any of this work yourself. Our company will bear no responsibility for accidents or injuries caused by improper mounting or mishandling.
- Use the monitor with the surface perpendicular to a level surface. If necessary, the monitor may be tilted up to 20 degrees upward.
- When moving the monitor, be sure to hold it with the handles and the unit bottom. Do not grasp the screen, tray, speaker, or speaker cover. This may cause product damage, failure, or injury.
- This monitor should be used at an ambient temperature between 41°F (5°C) and 95°F (35°C).
- Be careful of high temperatures in the surrounding area. When installing the monitor inside a housing, or if the ambient temperature may be outside of the range of 41°F (5°C) to 95°F (35°C), install a fan or take other measures to keep the ambient temperature within the required range.
- Temperature condition may change when using the monitor together with the optional equipments recommended by SHARP. In such cases, please check the temperature condition specified by the optional equipments.
- Do not block any ventilation openings. If the temperature inside the monitor rises, this could lead to a malfunction.
- Do not place the monitor on a device which generates heat.

- Adhere to the following when installing the monitor in its portrait orientation. Failing to adhere to the following may cause malfunctions.
 - Install the monitor such that the power LED is located on the bottom side.

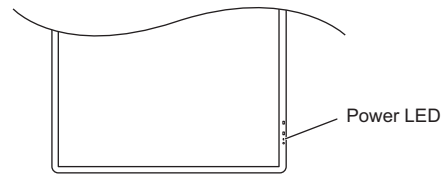

- Set the MONITOR on the MONITOR menu to PORTRAIT. (See page 33.)
- Be sure to clamp the power cord (supplied) onto the cable clamp attachment using the supplied cable clamp. When clamping the power cord, take care not to stress the terminal of the power cord. Do not bend the power cord excessively.

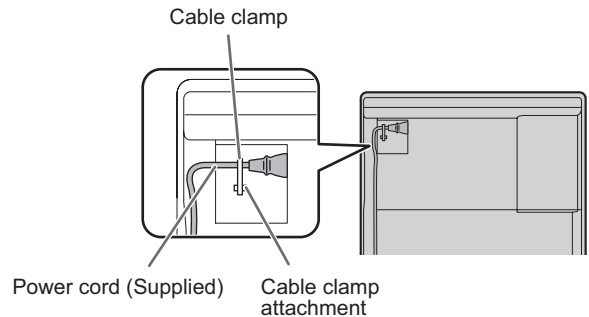

- Use the supplied vertical sticker when you install the monitor in portrait orientation.

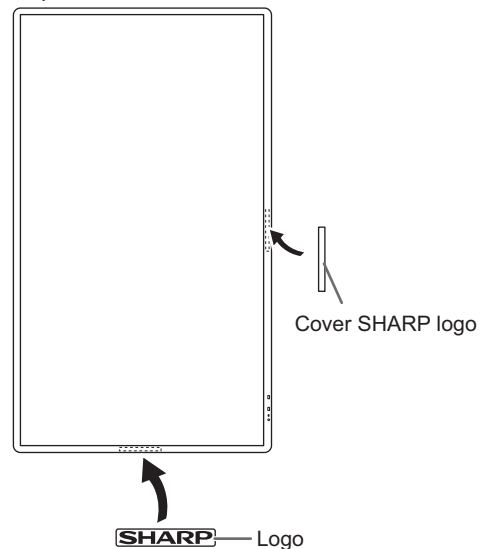

Contents

IMPORTANT INFORMATION	3	Basic Operation	24
DEAR SHARP CUSTOMER	4	Using the touch menu	24
SAFETY PRECAUTIONS	4	Using the remote control unit	25
TIPS AND SAFETY INSTRUCTIONS	6	Menu Items	27
MOUNTING PRECAUTIONS	7	Displaying the menu screen.....	27
Supplied Components	9	Menu item details	28
System Requirements	9	Adjustments for PC screen display	38
Part Names	10	Initialization (Reset)/Functional Restriction Setting (FUNCTION)	39
Connecting Peripheral Equipment	12	Controlling the Monitor with a PC (RS-232C)	40
Connecting the Power Cord	14	PC connection.....	40
Binding Cables	14	Communication conditions	40
Preparing the Remote Control Unit	15	Communication procedure	40
Installing the batteries	15	Setting of the GAMMA user data.....	42
Remote control operation range.....	15	RS-232C command table.....	43
Removing the Handles	16	Controlling the Monitor with a PC (LAN)	51
Mounting a web camera	16	Settings to connect to a LAN.....	51
Turning Power On/Off	17	Controlling with a PC.....	53
Turning on the main power.....	17	[Advanced operation]	
Turning power on	17	Command-based control.....	59
Turning power off	17	Troubleshooting	60
Touch Panel / Touch Pen Preparations	19	Specifications	62
Connecting the touch pen adapter	19	Mounting Precautions (For SHARP dealers and service engineers)	67
Touch Pen Preparations.....	19		
Computer preparations	19		
Calibration	19		
Touch pen actions	20		
Adding touch pens (pairing)	20		
Touch action	21		
Touch action	21		
Other functions.....	23		
Cautionary points	23		
Eraser.....	23		

For information on Touch Pen Utility, Touch Panel Settings Tool, Pen Software, Touch Display Downloader and Touch Display Link, see the manual for each.

Supplied Components

If any components are missing, please contact your dealer.

- Liquid Crystal Display Monitor: 1
- Remote control unit: 1
- Power cord: 1
- Remote control unit battery (R-6 ("AA" size)): 2
- Cable clamp: 3
- Cable clamp (insertion type): 4
- CD-ROM (Utility Disk): 1
- CD-ROM (Touch Display Link): 1
- Touch Display Link License: 1
- Setup Manual: 1
- Touch pen (for capacitive touch panel): 2
- Touch pen adapter: 1
- Pen tip for touch pen (for capacitive touch panel): 4
- Touch pen battery (LR-03 ("AAA" size)): 2
- Tray: 1
- Speaker cover: 2
- USB cable: 1
- RS-232C conversion cable (3.5mm mini jack): 1
- Eraser (for capacitive touch panel): 1
- Camera mount: 1
- Camera screw (inch thread): 1
- Touch pen adapter screw (Step screw, M3): 1
- Speaker cover attachment screws (M3)/ Camera mount screws (M3): 6
- Vertical sticker (Logo): 1
- ID labels (for touch pen): 4 x 2
- Cover SHARP logo: 1



Place this sticker onto the SHARP logo to cover the logo.

- * SHARP Corporation holds authorship rights to the Utility Disk program. Do not reproduce it without permission.
- * For environmental protection!
Do not dispose of batteries in household waste. Follow the disposal instructions for your area.

System Requirements

Computer	PC/AT compatible computer with a USB 2.0 port and able to output a resolution of 1920 x 1080. (CD-ROM drive required for software installation.)
OS	Windows 7 (32-bit or 64-bit version), Windows 8 (32-bit or 64-bit version), Windows 8.1 (32-bit or 64-bit version)
CPU	Intel Celeron or AMD Sempron 1.6 GHz or faster Intel Core 2 Duo or AMD Athlon II X2 2.8 GHz or faster recommended
Memory	At least 2 GB
Free space on hard drive	At least 200 MB (free space separately required for data storage)

To use the touch panel, the touch panel and computer must be connected, and Touch Panel Settings Tool, Touch Pen Utility, and Pen Software must be installed on the computer from the supplied CD-ROM.

When the Touch Display Downloader is installed, you can check and download the most recent versions of the software programs. To install the software, see the manual for each.

The USB port varies depending on the terminal connected to the computer.

D-sub 1 input terminal/DisplayPort input terminal/HDMI 1 input terminal	USB 1 port
D-sub 2 input terminal/HDMI 2 input terminal/HDMI 3 input terminal	USB 2 port

(Factory setting. Can be changed in TOUCH INPUT SELECT in the SETUP menu.)

Download the setup program for the Touch Viewer with the Touch Display Downloader.

Part Names

■ Front view

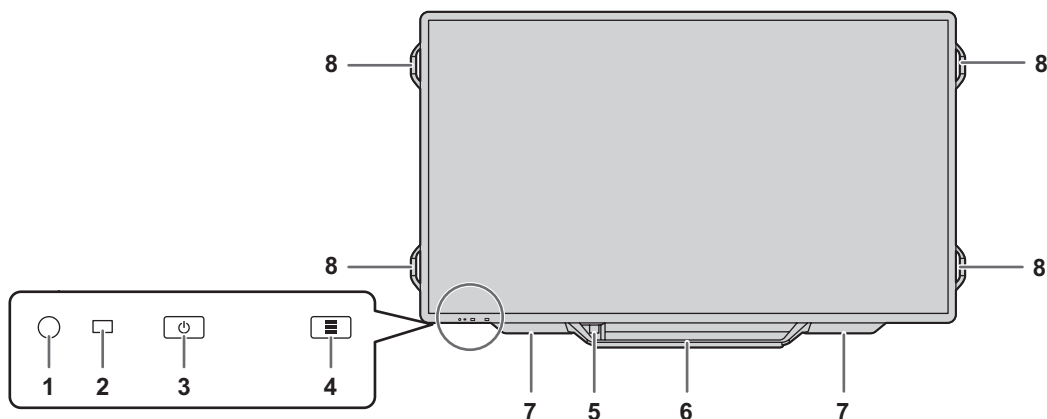

1. Remote control sensor (See page 15.)
2. Power LED (See page 17.)
3. Power button (See page 17.)
4. TOUCH MENU button (See page 24.)

5. **USB port (for USB device) (USB 2.0 compliant)**
To use, remove the seal and connect the USB cable on the back of the tray ("31") to the computer. (See page 13.)
6. Tray
7. Speakers
8. Handles

■ Rear view

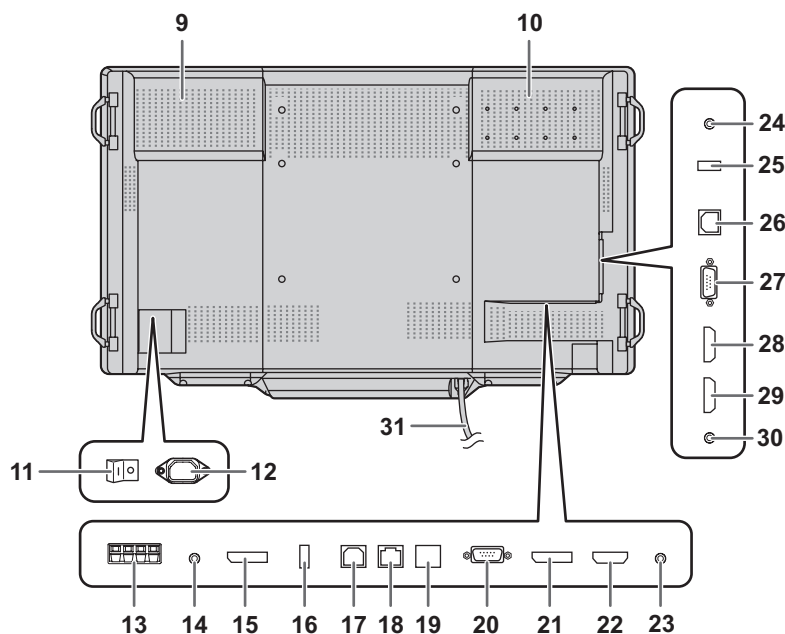

9. Vents
10. **Optional attachment section**
This section is used to connect optional hardware for function expansion. Offering this attachment location is not a guarantee that future compatible hardware attachments will be released.
11. Main power switch (See page 17.)
12. AC input terminal (See page 14.)
13. External speaker terminals (See page 13.)
14. Audio output terminal (See page 13.)
15. DisplayPort output terminal (See page 13.)
16. Touch pen adapter port (See page 19.)
17. USB 1 port (for touch panel) (See page 13.)
18. LAN terminal (See page 13.)
19. **Optional terminal**
This terminal is provided for possible future (optional) function expansion. Offering of this terminal is not a guarantee that future expanded functionality will be provided.
20. D-sub 1 input terminal (See page 12.)
21. DisplayPort input terminal (See page 12.)
22. HDMI 1 input terminal (See page 12.)
23. Audio 1 input terminal (See page 13.)
24. RS-232C input terminal (See page 13.)
25. Terminal for firmware updating
Normally not used.
26. USB 2 port (for touch panel) (See page 13.)
27. D-sub 2 input terminal (See page 12.)
28. HDMI 2 input terminal (See page 12.)
29. HDMI 3 input terminal (See page 12.)
30. Audio 2 input terminal (See page 13.)
31. USB cable (See page 13.)

TIPS

- It is convenient to use the terminals for separate purposes; for example, using the terminal on the bottom of the monitor to connect a fixed computer and using the terminal on the side of the monitor to connect a mobile computer.

! Caution

- Consult your SHARP dealer for attachment/detachment of optional parts.

■ Remote control unit

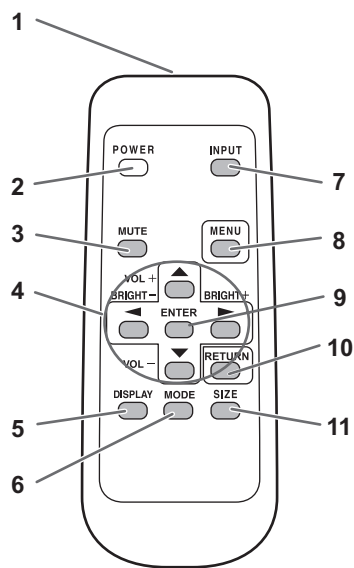

1. Signal transmitter
2. POWER button (See page 17.)
3. MUTE button (See page 25.)
4. VOL +/- buttons (See page 25.)
BRIGHT +/- buttons (See page 25.)
Cursor control (▲ / ▼ / ◀ / ▶) buttons
5. DISPLAY button (See page 25.)
6. MODE button (See page 25.)
7. INPUT button (See page 25.)
8. MENU button (See page 25.)
9. ENTER button (See page 25.)
10. RETURN button (See page 25.)
11. SIZE button (See page 25.)

Connecting Peripheral Equipment

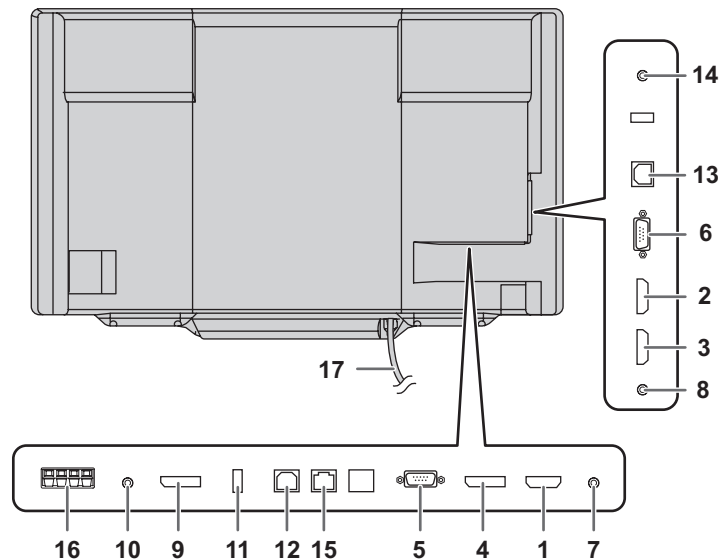

! Caution

- Be sure to turn off the main power switch and disconnect the plug from the power outlet before connecting/disconnecting cables. Also, read the manual of the equipment to be connected.
- Be careful not to confuse the input terminal with the output terminal when connecting cables. Accidentally reversing cables connected to the input and output terminals may cause malfunctions and the other problems.
- Do not use any cable that has a damaged or deformed terminal. Using such cables may cause malfunctions.

TIPS

- When using a touch panel, connect the USB cable to the computer. For details, see the Touch Panel Settings Tool Operation Manual.
- Images may not be displayed properly depending on the computer (video card) to be connected.
- Use the automatic screen adjustment when a computer screen is displayed for the first time using D-SUB1 or D-SUB2, or when the setting of the computer is changed. The screen is adjusted automatically when SELF ADJUST in the MONITOR menu is set to ON.
- If the audio output from the playback device is connected directly to speakers or other devices, the video on the monitor may appear delayed from the audio portion. Audio should be played through this monitor by connecting the playback device to the monitor's audio input, and connecting the monitor's audio output to the speakers or other devices.
- The audio input terminals used in each input mode are factory-set as follows.

Input mode	Audio input terminal (Factory setting)
D-SUB1	Audio 1 input terminal
D-SUB2	Audio 2 input terminal
DisplayPort	DisplayPort input terminal
HDMI1	HDMI 1 input terminal
HDMI2	HDMI 2 input terminal
HDMI3	HDMI 3 input terminal

It is convenient to use the terminals for separate purposes; For example, using the terminal on the bottom of the monitor to connect a fixed computer and using the terminal on the side of the monitor to connect a mobile computer.

1. HDMI 1 input terminal

2. HDMI 2 input terminal

3. HDMI 3 input terminal

- Use a commercially available HDMI cable (conforming to the HDMI standard).
- Set HDMI1/HDMI2/HDMI3 of INPUT SELECT on the SETUP menu according to the device to be connected.
- Select the audio input terminal to be used in AUDIO SELECT of the SETUP menu.

When HDMI is selected, connection to the audio input terminal is unnecessary.

4. DisplayPort input terminal

- Use a commercially available DisplayPort cable (conforming to the DisplayPort standard).
 - Select the audio input terminal to be used in AUDIO SELECT of the SETUP menu.
- When DisplayPort is selected, connection to the audio input terminal is unnecessary.

5. D-sub 1 input terminal

- Set D-SUB1 of INPUT SELECT on the SETUP menu according to the device to be connected.
- To use with D-SUB1[VIDEO], connect the green terminal to the device's video output.
- Select the audio input terminal to be used in AUDIO SELECT of the SETUP menu.

6. D-sub 2 input terminal

- Select the audio input terminal to be used in AUDIO SELECT of the SETUP menu.

7. Audio 1 input terminal

8. Audio 2 input terminal

- Use an audio cable without resistance.
- Set the audio input terminal to be used in each input mode in AUDIO SELECT on the SETUP menu.

9. DisplayPort output terminal

- The screen displayed on the monitor and the audio output from the monitor can be output to an external device.
- Use a commercially available DisplayPort cable (conforming to the DisplayPort standard).
- Outputting HDCP-encrypted video requires an external device which supports HDCP.

10. Audio output terminal

- The output sound varies depending on the input mode.
- The volume of the output sound can be fixed by setting AUDIO OUTPUT of AUDIO OPTION on the SETUP menu.
- It is not possible to control the sound output from the audio output terminals with the AUDIO menu.

11. Touch pen adapter port

- Connect the touch pen adapter in order to use the touch pen. (See page 19.)

12. USB 1 (type B) port

- To use the touch panel with a computer connected to the terminal below, connect the touch panel to the computer with a USB cable.

(Factory setting. Can be changed in TOUCH INPUT SELECT on the SETUP menu.)

- D-sub 1 input terminal
- DisplayPort input terminal
- HDMI 1 input terminal

13. USB 2 (type B) port

- To use the touch panel with a computer connected to the terminal below, connect the touch panel to the computer with a USB cable.

(Factory setting. Can be changed in TOUCH INPUT SELECT on the SETUP menu.)

- D-sub 2 input terminal
- HDMI 2 input terminal
- HDMI 3 input terminal

14. RS-232C input terminal

- The monitor can be connected to a PC using the RS-232C conversion cable (supplied) and a commercially available RS-232 straight cable to control the monitor from the PC.

15. LAN terminal

- You can control the monitor from a computer on a network by connecting a commercially available LAN cable between this terminal and a network.

16. External speaker terminals

- To use external speakers, set SPEAKER SELECT to EXTERNAL in AUDIO OPTION on the SETUP menu.
- Be sure to use external speakers with an impedance of 6 Ω or greater and a rated input of at least 10 W.

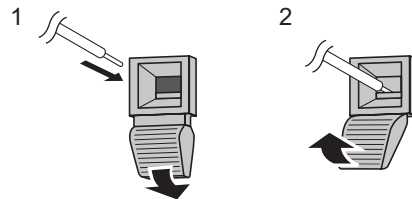

1. While pushing the tab, insert the tip of the cable.
2. Release the tab.

TIPS

- Be sure to connect the + and - terminals and the left and right speakers properly.
- Avoid short circuiting the + and - terminals.
- When SPEAKER SELECT is set to EXTERNAL, the internal speakers are disabled.

17. USB cable

- To use the USB port on the front of the tray (for USB device) (USB 2.0 compliant), connect the USB cable to the USB port on the computer.

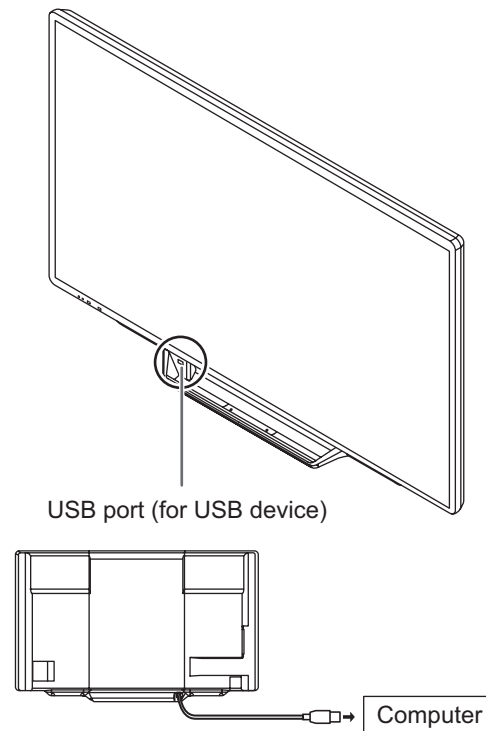

* The touch panel must be connected separately.

Connecting the Power Cord

! Caution

- Use only the power cord supplied with the monitor.
1. Turn off the main power switch.
 2. Plug the power cord (supplied) into the AC input terminal.
 3. Plug the power cord (supplied) into the AC power outlet.

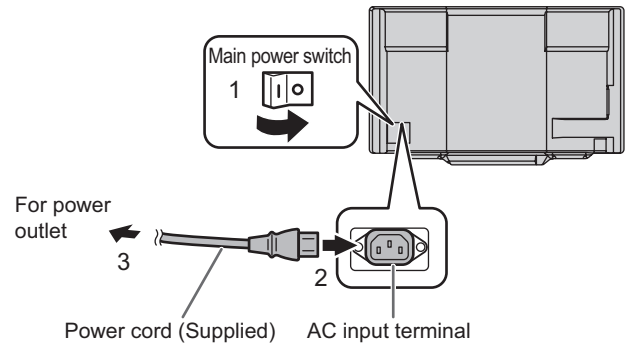

Binding Cables

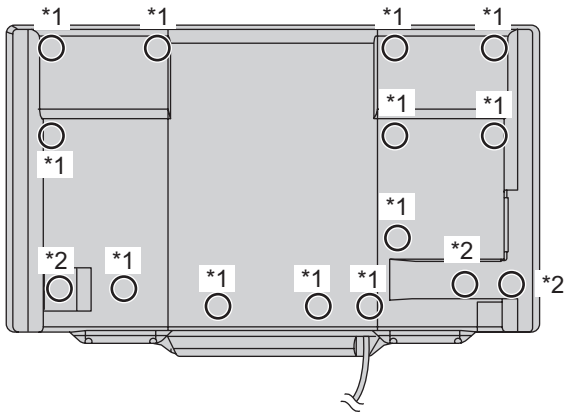

The cables connected to the terminals on the rear of the monitor and the USB cable on the back of the tray can be fastened with the cable clamp.

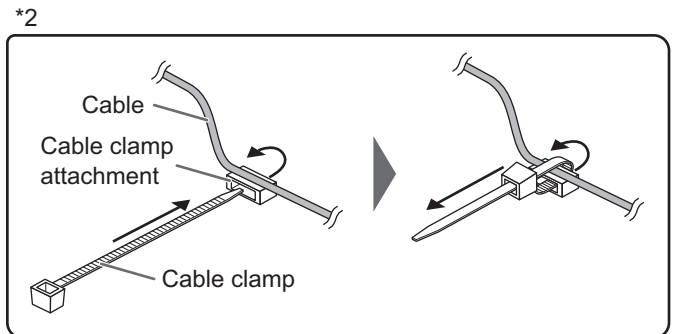
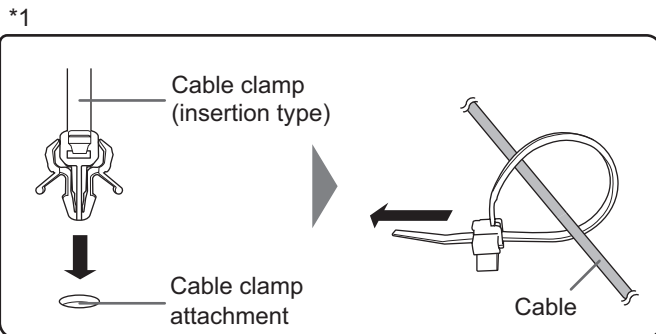

Preparing the Remote Control Unit

Installing the batteries

1. Press the cover gently and slide it in the direction of the arrow.

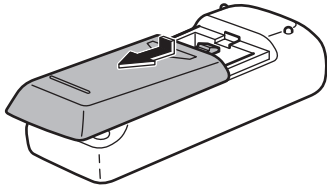

2. See the instructions in the compartment and put in the supplied batteries (R-6 ("AA" size) x 2) with their plus (+) and minus (-) sides oriented correctly.
3. Close the cover.

TIPS

- When the batteries become exhausted, replace them with new (commercially available) batteries.
- The supplied batteries (R-6 ("AA" size) x 2) may become exhausted quickly depending on how they are stored.
- If you will not be using the remote control for a long time, remove the batteries.
- Use manganese or alkaline batteries only.

Remote control operation range

The operation range of the remote control unit is approx. 16.4 feet (5 m) at an angle of approx 10° from the center to the top/bottom/right/left of the remote control sensor.

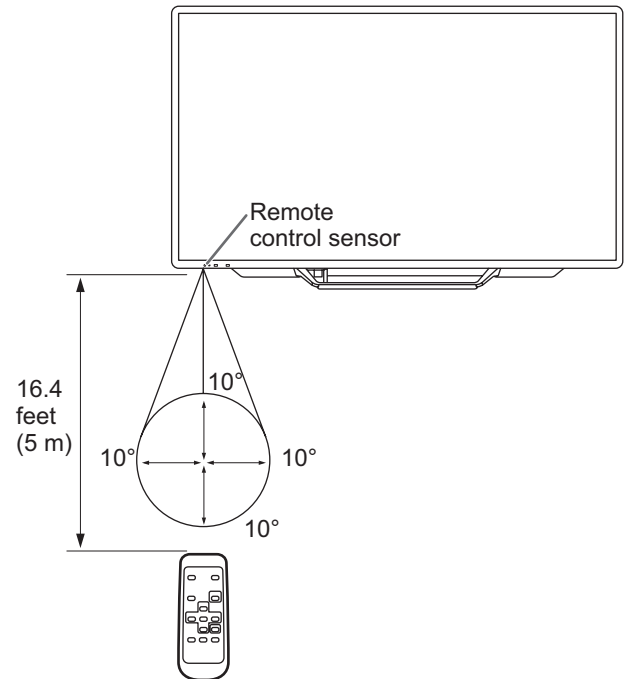

TIPS

- Do not expose the remote control unit to shock by dropping or stepping on it. This could lead to a malfunction.
- Do not expose the remote control unit to liquids, and do not place it in an area with high humidity.
- The remote control unit may not work properly if the remote control sensor is under direct sunlight or strong lighting.
- Objects between the remote control unit and the remote control sensor may prevent proper operation.
- Replace the batteries when they run low as this may shorten the remote control's operation range.
- If a fluorescent light is illuminated near the remote control unit, it may interfere with proper operation.
- Do not use it with the remote control of other equipment such as air conditioner, stereo components, etc.

Removing the Handles

The handles can be removed.

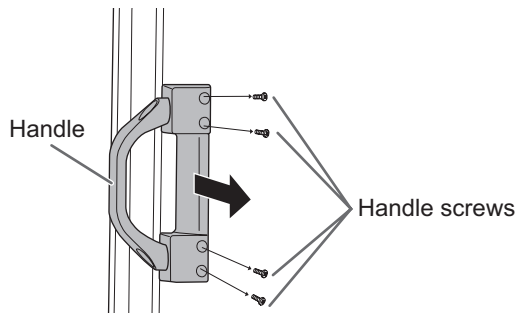

! Caution

- The removable handles and handle screws are for use with this monitor. Do not use them for any other devices.
- To attach handles, be sure to use the handles and handle screws which were removed from this monitor.
- Be sure the handles are attached securely.

Mounting a web camera

It is possible to mount a commercially available web camera in the following positions:

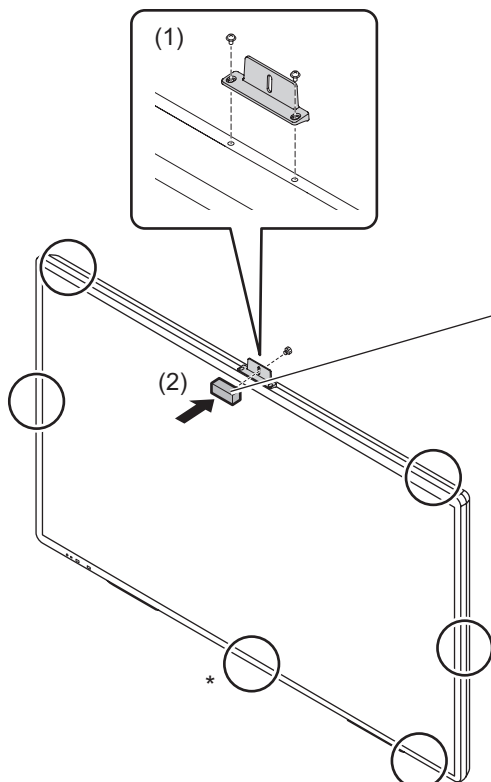

- (1) Attach the supplied camera mount with the supplied camera mount screws (x2).
- (2) Attach the web camera to the camera mount with the supplied camera screw (inch thread) (x1).

* The camera mount cannot be attached when the tray is attached. To attach the camera mount, remove the tray mount fitting. (See page 68.)

Turning Power On/Off

! Caution

- Turn on the monitor first before turning on the computer or playback device.
- When switching the main power switch or the POWER button off and back on, always wait for at least 5 seconds. A short interval may result in a malfunction.

Turning on the main power

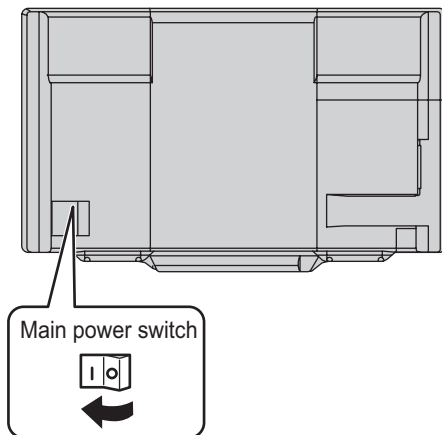

! Caution

- The main power must be turned on/off with the main power switch. Do not connect/disconnect the power cord or turn the breaker on/off while the main power switch is on.
- For a complete electrical disconnection, pull out the main plug.

Turning power on

Press the POWER button to turn the power ON.

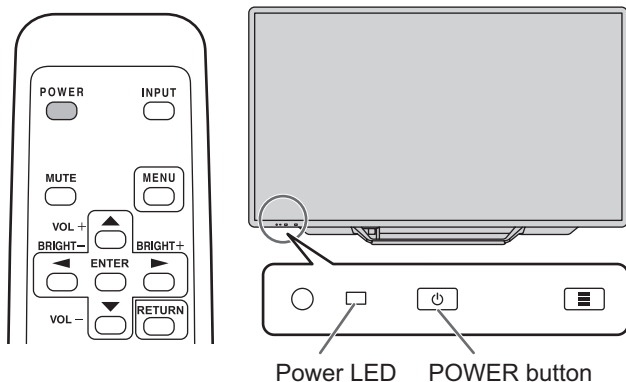

Status	Status of the monitor
Green lit	Power on
Orange lit	Power off (Standby mode)
Green flashing	Input signal waiting mode

TIPS

- You can fix the input mode that appears after startup. Set START INPUT MODE on the SETUP menu.

Turning power off

Turning power off with monitor buttons

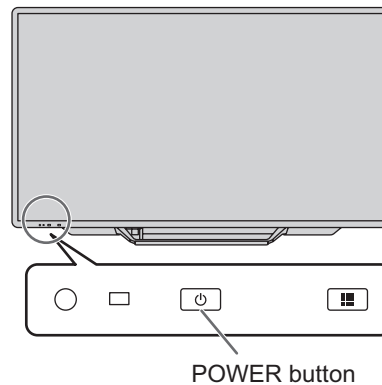

1. Touch the **POWER** button.
The recognition screen appears.
2. Touch **[OK]**.
The power is turned off. (Standby mode)

TIPS

- If about 15 seconds elapses while the recognition screen appears, the power will automatically turn off.

Turning power off with remote control unit

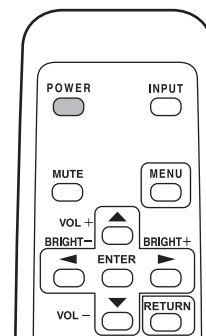

1. Press the **POWER** button.
The power is turned off. (Standby mode)

TIPS

- When the main power switch is off, the monitor cannot be turned on.
- If the monitor is in input signal waiting mode and you press the POWER button, the monitor enters standby mode.
- Setting the SCHEDULE flashes the power LED alternately in red and orange in standby mode.
- To disable the logo screen from displaying when turning the power ON, set LOGO SCREEN to OFF on the OTHERS menu. (See page 35.)

Turning Power On/Off

■Date/time setting

- If the time has yet to be set when the monitor is first turned on, the date/time setting screen appears. Set the date and time.

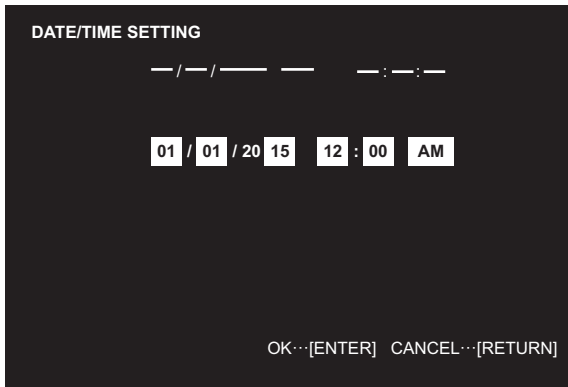

1. Press or to select the date and time, and press or to change the numerical values.
 2. Press .
- Be sure to set the date and time.
 - The date/time setting screen will close automatically if no operation is performed for about 15 seconds. The date and time can be set using DATE/TIME SETTING from the SETUP menu when the date/time setting screen disappears.

TIPS

- Set the date in "Month/Day/Year" order.
- Set the time on a 12-hour basis.
- The clock is maintained by the internal battery.
- If you already set the time but the date/time setting screen appears when the power is turned on, the internal battery may be exhausted. Please contact your local SHARP servicing dealer or service center for assistance with battery replacement.
- Estimated service life of the internal battery: About 5 years (depending on monitor operation)
- The initial battery was inserted at the factory when the monitor was shipped, so it may run out of power before its expected operation life.

Touch Panel / Touch Pen Preparations

Connecting the touch pen adapter

To use the touch pen, insert the touch pen adapter into the touch pen adapter port on the monitor.

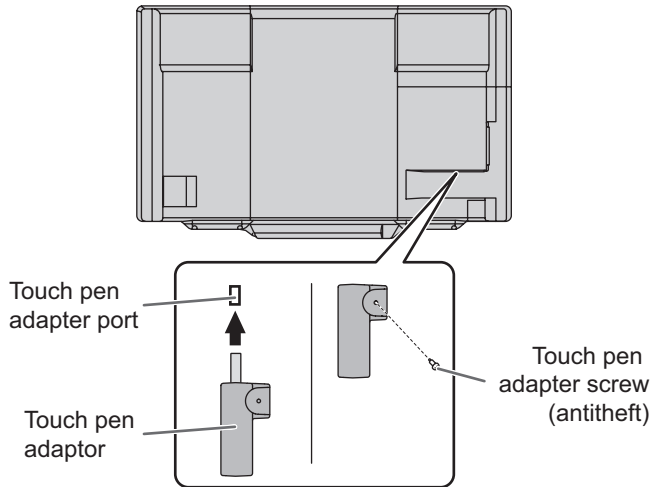

Computer preparations

To use the touch panel, the touch pen and the eraser, install the software below.

- Touch Panel Settings Tool
- Touch Pen Utility
- Pen Software

To install the software, see the manual for each.

TIPS

- When the monitor is installed in the portrait orientation, the operation of the touch pen, eraser, and pen software are not guaranteed.

Installed in portrait orientation

- The touch pen adapter does not need to be connected.
- The Touch Pen Utility and Pen Software do not need to be installed.

Touch Pen Preparations

■ Inserting the battery

2 touch pens are supplied. Insert the batteries in the touch pens.

1. Remove the battery cap.
2. Open the cover and insert the supplied battery (LR-03 ("AAA" size) x 1) into the touch pen.

Check the plus (+) and minus (-) markings on the inside of the touch pen and insert the battery in the correct orientation.

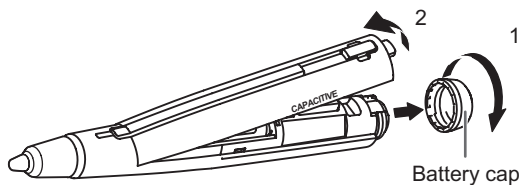

3. Replace the cover and battery cap.

TIPS

- The supplied battery (LR-03 ("AAA" size)) may be exhausted in a short time, depending on how it was stored.
- If the touch pen will not be used for an extended time, remove the battery from the touch pen.
- For the battery, use an alkaline battery.
- You can affix the supplied ID labels to distinguish the touch pens.

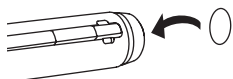

Calibration

If the touch position is out of place, perform position alignment. Perform calibration from the Touch Panel Settings Tool. For details, see the Touch Panel Settings Tool Operation Manual.

Touch pen actions

Only use touch pens that are used with this monitor (supplied touch pens or optional PN-ZL03).

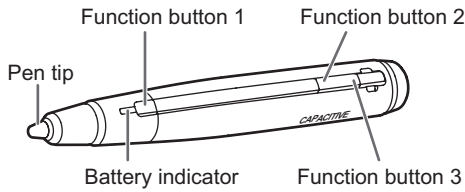

The factory default settings for the function buttons are as follows.

- Function button 1 : Pen Software Link
- Function button 2 : PageDown
- Function button 3 : PageUP

You can change the functions that are assigned to the function buttons. For details, see the Touch Pen Utility Operation Manual.

Using as a digitizer pen

A touch pen can be used as a Windows digitizer pen. To use a touch pen as a digitizer pen, change the "Input mode" to "Pen Digitizer" in the Touch Pen Utility. For details, see the Touch Pen Utility Operation Manual.

The function buttons are used differently when the pen is a digitizer pen. To use a function, touch the screen while holding down the button of that function.

TIPS

- Hold the touch pen at the part indicated below. Incorrect operation may result if your finger is too close to the tip of the pen.

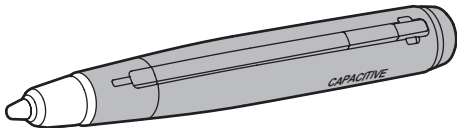

- When the function button is pressed, the battery indicator illuminates. If the battery indicator does not illuminate, check if the battery is depleted.
- Use function buttons near the front of the screen. If too far away, operation will not be possible.
- Press function buttons slowly and firmly. If pressed too quickly, the action may not be recognized.
- The line may break if the touch pen battery is low or there is other wireless equipment in operation nearby.
- If the pen tip becomes damaged and the touch panel does not respond, replace the pen tip.
 - * When inserting the pen tip, insert firmly all the way in.

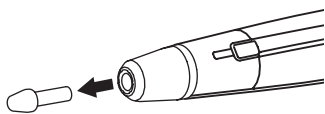

- The pen tip is made soft to protect the screen and improve writability. For this reason, the pen tip may become deformed, however, this is not a failure.
- The touch pens cannot be used as touch pens and digitizer pens at the same time. When the setting is changed in the Touch Pen Utility, all touch pens become digitizer pens. Multiple digitizer pens cannot be used at the same time.

Touch pen settings

Touch pen settings are configured using the Touch Pen Utility. For details on the settings and how to use the utility, see the Touch Pen Utility Operation Manual.

Adding touch pens (pairing)

- Up to 4 touch pens can be used simultaneously. (Up to 10 touch pens can be registered.)
- To use an optional touch pen with the monitor, the touch pen must be registered in the touch pen adapter. (pairing)

Item	Model	Remarks
Touch pen	PN-ZL03	For capacitive touch panel

Perform touch pen pairing for one pen at a time.

1. Click the **Touch Pen Utility** icon () on the taskbar.
2. Click [Touch pen settings].
3. Select a line in the touch pen settings screen that does not have a pen registered, and touch [Registration].

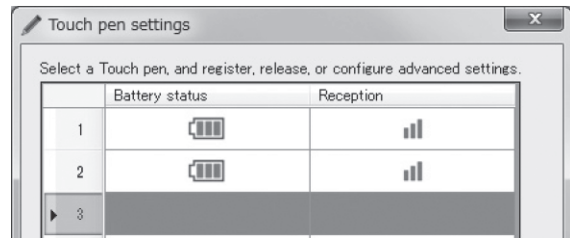

4. Simultaneously hold down function button 1 and function button 3 of the touch pen being paired for at least 5 seconds.
5. When the battery indicator blinks twice or more, release function button 1 and function button 3. A message appears after completion of pairing.
6. Touch [OK].

TIPS

- When multiple touch pens are used, touch positions and touch pen information (color, thickness, etc.) may become interchanged, and lines may break.
 - When touched simultaneously
 - When touch pens are moved near each other
 - When batteries are low
 - When other wireless equipment is operating nearby
- Do not press the pen tip on other than the screen. This may cause malfunctioning.
- One touch pen cannot be registered in multiple touch pen adapters.

Touch action

Touch action

Touch actions that can be used with this monitor differ according to operating system and application. The functions of touch actions are also different. For details, check Windows Help and the application's support documentation.

Touch Operation Mode	Multi-Touch Mode		Mouse Mode
	Windows 8 / 8.1	Windows 7	Windows 7 / 8 / 8.1
OS			
Touch action			
Single-tap	Yes	Yes	Yes
Double-tap	Yes	Yes	Yes
Swipe	Yes	Yes	No
Swipe from edge of screen	Yes	No	No
Drag-and-drop	Yes	Yes	Yes
Slide to pan	Yes	Yes	No
Flicks	Yes	Yes	No
Press-and-hold	Yes	Yes	Yes*
Zoom	Yes	Yes	No
Press-and-tap	No	Yes	No
Rotate	Yes	Yes	No

* When "Recognize press and hold as right click" is set with the Touch Panel Settings Tool. The action may be different from a mouse right-click in some cases.

TIPS

- In Windows 7, if the checkmark has been removed from "Enable multi-touch gestures and inking" in "Pen and touch" in Control Panel, select the checkbox.
- For the procedures for using the touch pen in the Pen Software, see the Pen Software Operation Manual.

Common finger and touch pen actions

Single-tap

Same action as left-clicking a mouse. Touch with your finger/touch pen.

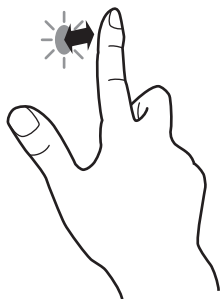

Double-tap

Same action as double-clicking a mouse. Quickly touch twice with your finger/touch pen.

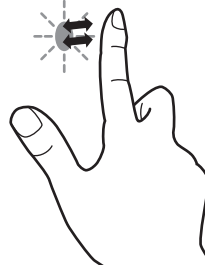

When double-tapping with your finger, be sure to lift your finger sufficiently off the screen after the first tap. If there is insufficient distance between the screen and your finger, double-tap will not take place.

Swipe

Touch the screen with your finger/touch pen, move without lifting, and then stop.

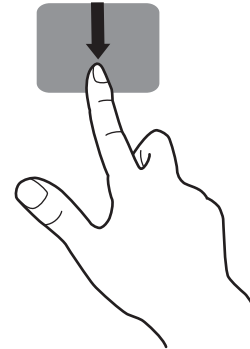

Swipe from edge of screen

After touching the edge of the monitor with your finger/touch pen, move horizontally without releasing your finger/touch pen and then stop.

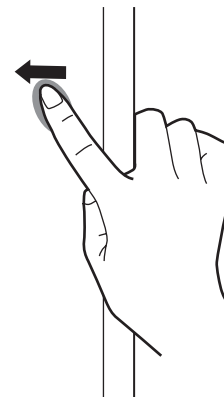

Touch action

Drag-and-drop

Same action as drag-and-drop with a mouse. Touch the screen with your finger/touch pen and move without lifting. When you have finished the movement, lift your finger/touch pen.

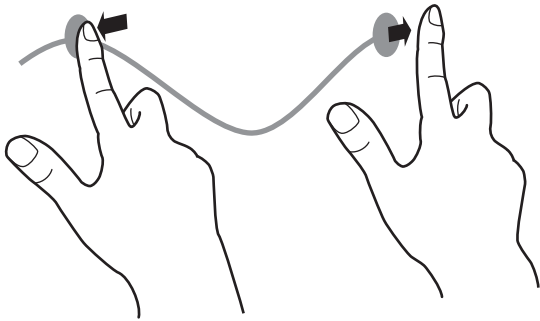

Flicks

Flick your finger/touch pen in the direction of the function you want to use.

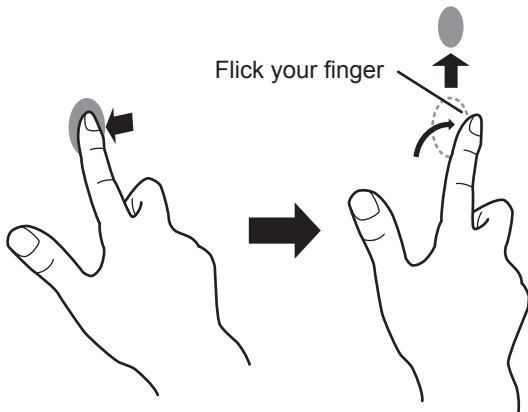

Press-and-hold

Same action as right-clicking a mouse. Press briefly with your finger/touch pen, and then lift your finger/touch pen from the screen.

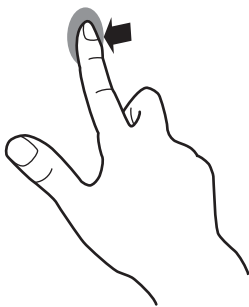

Slide to pan

With your finger/touch pen touching the screen, move it up and down to scroll the screen.

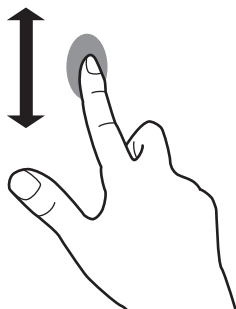

■ Finger actions

Zoom

Use in a screen that is capable of enlargement/reduction. Touch the screen with two fingers and move your fingers closer together to reduce the view, or apart to enlarge the view.

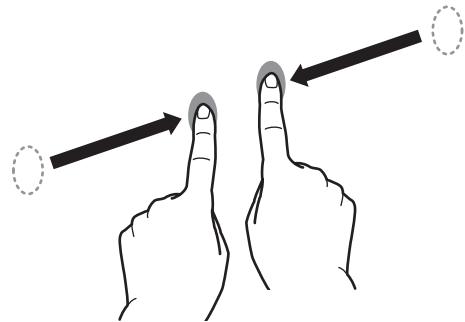

Reduction

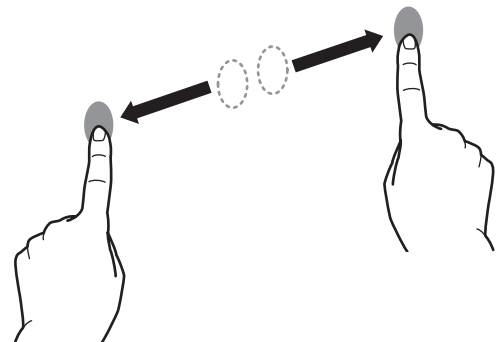

Enlargement

Press-and-tap

Same action as right-clicking a mouse. With one finger touching the screen, tap once (single tap) with another finger.

Tap once (single tap) with another finger

With one finger touching

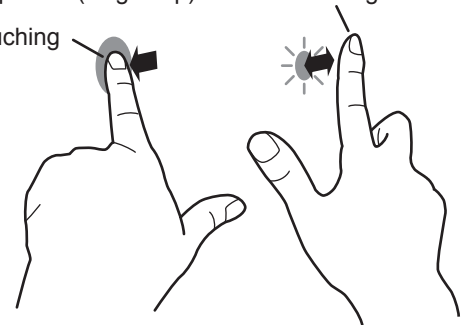

Rotation

Use this action in a screen that is capable of image rotation. Touch the center point of the rotation with one finger. While holding that finger still, move another finger in the desired direction of rotation.

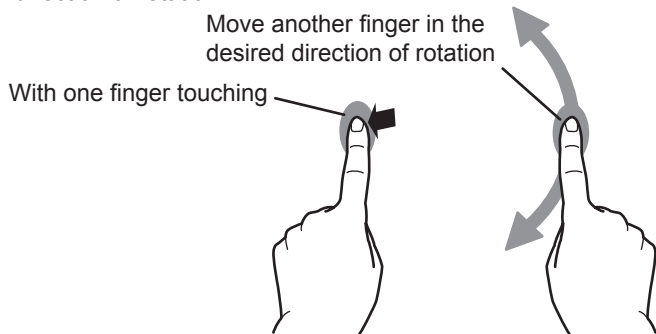

TIPS

- The screen may not respond correctly in the following cases:
 - Touch gesture is too quick
 - The distance between the two points is too short
 - The two points intersect

Other functions

In Windows 8/8.1, input panel functions can be used.

In Windows 7, touch pointer and input panel functions can be used.

For information on these functions, see Windows Help.

Touch pointer :

A translucent image of a mouse appears near the point touched. The left/right buttons of the image can be clicked to perform the same actions as left/right clicking a mouse.

Input panel :

A software keyboard and an input panel with handwriting recognition appear on the screen.

Windows 8/8.1 and Windows 7 (excluding Starter), the ink function of Microsoft Office can be used.

Handwritten comments can be written, and handwriting can be recognized.

For details, see Microsoft Office Help.

Cautionary points

- Note the following when touching by finger:
 - Do not touch with a wet finger.
 - Touch with the ball of your finger.
 - Touch with your bare finger.
 - The screen will not respond if you are wearing a glove.
- Do not use the touch pen for any purpose other than touch panel operation.
- Do not press hard on the pen tip.
- This may not operate correctly if there is an inverter fluorescent light nearby.
- Do not store with the pen tip of the touch pen or function button pressed. The battery will be exhausted.
- If there is dirt or foreign matter on the tip of the touch pen, remove it. Foreign matter may damage the screen.
- The touch pen position may occasionally deviate in the login screen. In this case, use the keyboard or mouse.
- If the USB cable becomes disconnected, the touch panel may not operate correctly after the USB cable is reconnected. In this case, restart the computer.

Eraser

Only use an eraser that is supplied with this monitor. The eraser is used with the Pen Software. For the procedure for using the eraser, refer to the Pen Software Operation Manual.

! Caution

- Hold the main body of the eraser with your bare fingers. The screen will not respond if you are wearing a glove.

The main body

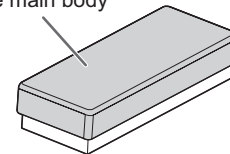

- Slowly place the large face of the eraser fully on the screen. Insufficient contact may prevent the eraser from being recognized. Touching the screen with one of the non-cloth sides will damage the screen.

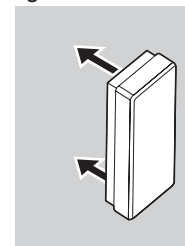

- If there is any dirt or foreign matter on the surface that contacts the screen, remove it. Foreign matter may damage the screen.
- Place the eraser on the screen inside the display area. If the eraser first touches the frame (outside the display area) and then is moved inside the display area, the screen will not respond.

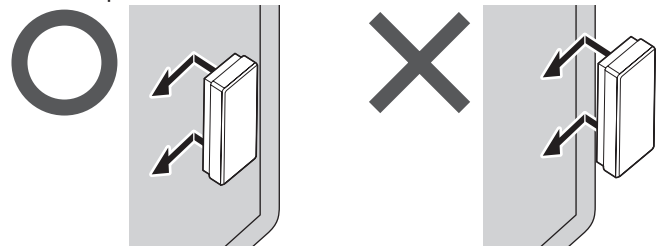

- When the "Input Mode" of the Touch Pen Utility is "Pen Digitizer":
 - Even if you use the eraser in the Pen Software, the eraser will be the standard size eraser.
 - The eraser can be used in the software below. Microsoft Office 2007/2010/2013

Basic Operation

Using the touch menu

You can touch the monitor to change input mode, volume, and other settings.

1. Touch the TOUCH MENU button.

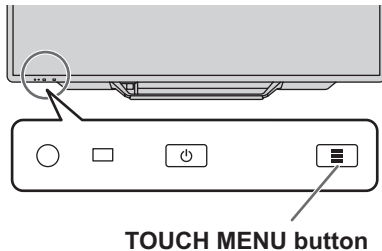

2. Touch the screen to change settings.

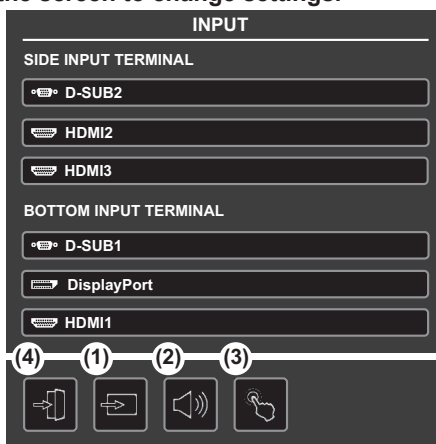

(1) INPUT (Input mode selection)

Changes the input mode.

Input mode	Video	Audio
DisplayPort	DisplayPort input terminal	*5
HDMI1	HDMI1 input terminal ^{*1}	
HDMI2	HDMI2 input terminal ^{*2}	
HDMI3	HDMI3 input terminal ^{*3}	
D-SUB1	D-sub1 input terminal ^{*4}	
D-SUB2	D-sub2 input terminal	

- When the input mode is changed, the touch panel connection also changes. You can set whether the side or bottom USB port is used in each input mode. (See page 32.)

- *1 Select the terminal to be used in HDMI1 of INPUT SELECT. (See page 31.)
- *2 Select the terminal to be used in HDMI2 of INPUT SELECT. (See page 31.)
- *3 Select the terminal to be used in HDMI3 of INPUT SELECT. (See page 31.)
- *4 Select the terminal to be used in D-SUB1 of INPUT SELECT. (See page 31.)
- *5 Select the terminal for AUDIO SELECT which is used for audio input. (See page 31.)

(2) Volume adjustment

Changes the volume.

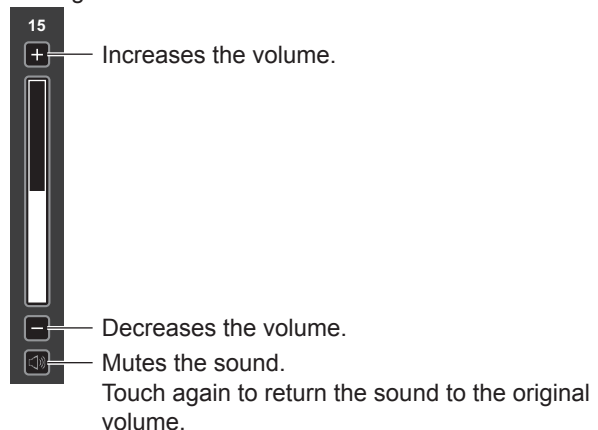

(3) Touch action setting

Touch to disable touch action.
Touch again to enable touch action.

TIPS

- When the input mode is changed, the disable touch action setting is canceled.
- When TOUCH OUTPUT INVALID ICON is set to ON and touch action is disabled, the TOUCH OUTPUT INVALID icon appears in the monitor.



- You can touch the TOUCH OUTPUT INVALID icon in the monitor to enable touch action.
- The position of the TOUCH OUTPUT INVALID icon can be changed. (See page 33.)
- The TOUCH OUTPUT INVALID icon appears even when a USB cable is not connected.

(4) Exit touch menu

Closes the touch menu.

TIPS

- The touch menu can also be used with the remote control unit.
 - (1) Hold down **DISPLAY** at least 5 seconds.
The touch menu appears.
 - (2) Select the setting item with **←** **→**.
 - (3) Set with **↑** **↓**, and press **ENTER**.
 - The setting is entered.
 - Press **RETURN** to exit the touch menu.

Using the remote control unit

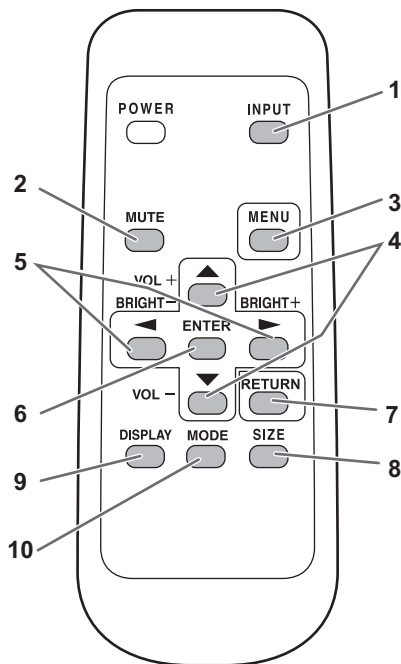

1. INPUT (Input mode selection)

The menu is displayed. Press or to select the input mode, and press to enter.

* For the input modes that can be selected, see “Using the touch menu” (See page 24.).

2. MUTE

Turns off the volume temporarily.

Press the MUTE button again to turn the sound back to the previous level.

3. MENU

Displays and turns off the menu screen. (see page 27.)

4. VOL +/- (Volume adjustment)

Pressing or displays the VOLUME menu when the menu screen is not displayed.



Press or to adjust the volume of the sound.

* If you do not press any buttons for about 4 seconds, the VOLUME menu automatically disappears.

* You can also change the setting by touch action.

5. BRIGHT +/- (Backlight adjustment)

Pressing or displays the BRIGHT menu when the menu screen is not displayed.

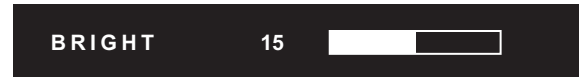

Press or to adjust the brightness.

* If you do not press any buttons for about 4 seconds, the BRIGHT menu automatically disappears.

6. ENTER

Confirms the setting.

7. RETURN

Returns to the previous screen.

8. SIZE (Screen size selection)

The menu is displayed.

Press or to select the screen size. (See page 26.)

9. DISPLAY

Displays monitor information.

The display changes from INFORMATION1 → INFORMATION2 → clear display, and so on every time you press this button.

- The display disappears automatically after about 15 seconds.
- is displayed during LAN communication.
- If is displayed in red, there is a duplicate IP address.

10. MODE (Color mode selection)

Each time you press this button, the color mode changes in the following order:

STD (Standard) → VIVID → sRGB → HIGH ILLUMINANCE → STD...
--

- sRGB applies to PC input only.
sRGB is international standard of color representation specified by IEC (International Electrotechnical Commission). Color conversion is made in taking account of liquid crystal's characteristics and represents color tone close to its original image.
- HIGH ILLUMINANCE is a display with colors suited to bright locations.

Basic Operation

■Switching the screen size

Even when the screen size is changed, the display may remain the same depending on the input signal.

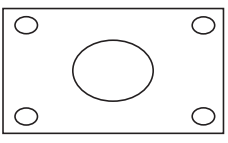
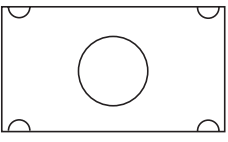
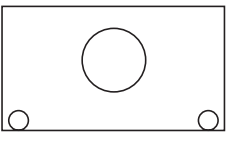
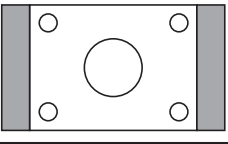
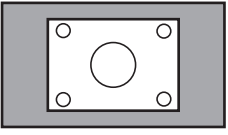
WIDE		PC input	Displays image so it fills the entire screen.
		AV input	An image with a 4:3 aspect ratio is stretched to fill the entire screen.
ZOOM 1		PC input	An image with a 4:3 aspect ratio is enlarged to fill the entire screen without changing the aspect ratio. The edges of the image may be cut off.
		AV input	
ZOOM 2		PC input	Use this size if ZOOM 1 cuts off the subtitles.
		AV input	
NORMAL		PC input	Displays image so it fills the screen without changing the aspect ratio of the input signals.
		AV input	Displays the entire image of the aspect ratio of 4:3 without changing the aspect ratio.
Dot by Dot		PC input	Displays the dots of the signals input from the connected PC as the corresponding dots on the screen.
		AV input	Displays the dots of the input signals as the corresponding dots on the screen.

TIPS

- Using this monitor's screen-size switching or dual-screen display functions to compress or expand the screen for commercial or public viewing in establishments like cafes or hotels may infringe on the rights of the creators, as protected by Copyright Law, so please be careful.
- When dual-screen display is selected, the screen size cannot be changed.
- The appearance of the original video may change if you select a screen size with a different aspect ratio than the original image (e.g. TV broadcast or video input from external equipment).
- When an ordinary non-wide image (4:3) is viewed with the whole screen using the screen-size switching function of this monitor, the edge of the image may be lost or appear distorted. If you wish to respect the creator's intentions, set the screen size to "NORMAL".
- When playing commercial software, parts of the image (like subtitles) may be cropped. In this case select the optimal screen size using the screen-size switching function of this monitor. With some software, there may be noise or distortion at the edges of the screen. This is due to the characteristics of the software, and is not a malfunction.
- Depending on the original image size, black bands may remain at the edges of the screen.

Menu Items

Displaying the menu screen

Video and audio adjustment and settings of various functions are enabled. This section describes how to use the menu items. See pages 28 to 35 for details of each menu items.

Caution

- Do not turn the main power switch off while the menu items are being displayed. Doing so may initialize the settings.

Example of operation

(Adjusting CONTRAST in the PICTURE menu)

- Press to display the menu screen.

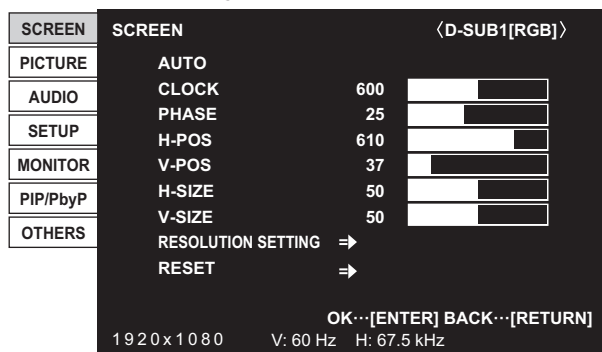

- Press or to select PICTURE, and press .

- Press or to select CONTRAST.

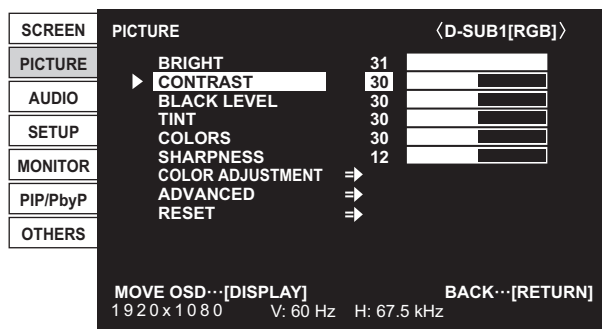

- Press or to adjust the setting.

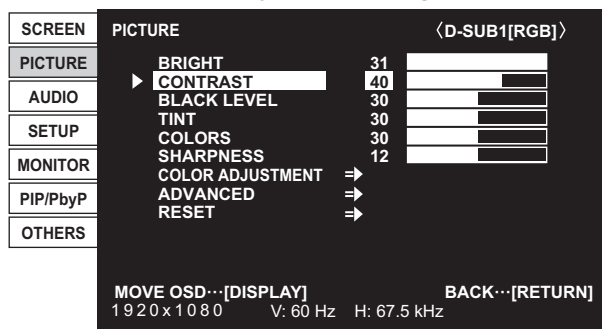

For items that have , press , make settings and then press .

- Press to close the menu screen.

TIPS

- The menu will differ depending on the input mode.
- The menu screen will close automatically if no operation is performed for about 15 seconds. (DATE/TIME SETTING, SCHEDULE and LAN SETUP screens will close in about 4 minutes.)

Menu screen display

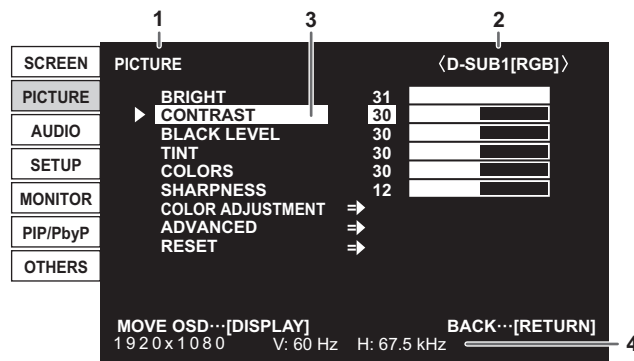

- Name of the menu
- Input mode
- An item being selected (highlighted)
- Screen resolution of input signal, and other data.

TIPS

- Items that cannot be selected appear in gray. (e.g. Function not supported by the current input signal)

Menu item details

The menu will differ depending on the input mode.

■ SCREEN

You can move the menu screen display position each time  is pressed.

AUTO (D-SUB1[RGB]/D-SUB2)

The CLOCK, PHASE, H-POS, and V-POS are automatically adjusted.

Pressing  performs adjustment. Use this automatic adjustment when you use the D-SUB1[RGB] or D-SUB2 to display a computer screen for the first time or when you change the setting of the computer. (See page 38.)

CLOCK (D-SUB1[RGB]/D-SUB2)

Adjusts frequency for sampling clock for applicable video.

Adjust when there is flickering in the form of vertical stripes.

When using the adjustment pattern (see page 38.), make adjustments so that no vertical stripe noise appears in it.

PHASE (D-SUB1[RGB]/D-SUB2)

Adjusts sampling clock phase for applicable video. Useful when small characters appear with low contrast and/or there are flickers at corners. When using the adjustment pattern (see page 38.), make adjustments so that no horizontal stripe noise appears in it.

H-POS

Adjust the horizontal position of the image.

V-POS

Adjust the vertical position of the image.

H-SIZE

Adjust the horizontal size of the image.

V-SIZE

Adjust the vertical size of the image.

RESOLUTION SETTING (D-SUB1[RGB]/D-SUB2)

H-RESOLUTION

Sets proper horizontal resolution when the resolution of input signals is not recognized properly.
(Adjustment may be impossible with some signals.)

V-RESOLUTION

Sets proper vertical resolution when the resolution of input signals is not recognized properly.
(Adjustment may be impossible with some signals.)

RESET

Resets the values of the SCREEN menu items to the factory preset values.

Select "ON" and then press .

■ PICTURE

You can move the menu screen display position each time  is pressed.

BRIGHT

Adjusts the backlight brightness. (In PIP mode, the main side setting is reflected in the image.)

CONTRAST

Adjusts the difference between the bright and dark portions of the image.

BLACK LEVEL

Adjusts the entire brightness of the video signals.

TINT

Adjusts the hue. Selecting + changes the color towards green, and selecting - changes it towards magenta.

COLORS

Adjusts the color intensity.

SHARPNESS

Adjusts the sharpness of the image.

COLOR ADJUSTMENT

COLOR MODE

Changes the color mode on the screen. The color mode on the screen can also be changed using a remote control unit. (See page 25.)

* sRGB is PC input only. See page 25 for details.

(In PIP mode, the main side setting is reflected in the image.)

WHITE BALANCE

THRU Displays the input signal level as is. (for PC input only)

PRESET Selects the color temperature using PRESET.

USER Used for adjusting R-/G-/B-CONTRAST and R-/G-/B-OFFSET respectively.

(In PIP mode, the main side setting is reflected in the image.)

PRESET

Selects the color temperature when the WHITE BALANCE is set to PRESET.

The setting values are shown for reference. The color temperature of the screen varies over time. This function is not intended to keep the color temperature constant.

USER

Adjusts each item when the WHITE BALANCE is set to USER.

R-CONTRAST.... Adjusts bright-toned red component.

G-CONTRAST ... Adjusts bright-toned green component.

B-CONTRAST Adjusts bright-toned blue component.

R-OFFSET Adjusts dark-toned red component.

G-OFFSET Adjusts dark-toned green component.

B-OFFSET Adjusts dark-toned blue component.

COPY TO USER

Copies the value of PRESET to the USER setting.

Select ON and then press .

(In the case other than white, color tone may differ from the PRESET.)

GAMMA

Selects the gamma. USER sets the gamma to the sent value (see page 42).

(In PIP mode, the main side setting is reflected in the image.)

FLESH TONE (AV input)

Adjust the hue control.

When FLESH TONE is set to LOW or HIGH, C.M.S.-HUE/-SATURATION/-VALUE cannot be set.

C.M.S.-HUE (AV input)

Adjusts color tone with 6 colors of R (red), Y (yellow), G (green), C (cyan), B (blue), and M (magenta).

C.M.S.-SATURATION (AV input)

Adjusts color vividness with 6 colors of R (red), Y (yellow), G (green), C (cyan), B (blue), and M (magenta).

C.M.S.-VALUE (AV input)

Adjusts color brightness with 6 colors of R (red), Y (yellow), G (green), C (cyan), B (blue), and M (magenta).

Menu Items

ADVANCED

AUTO (D-SUB1[RGB]/D-SUB2)

The ANALOG GAIN and ANALOG OFFSET are automatically adjusted.

Pressing performs adjustment.

ANALOG GAIN (D-SUB1[RGB]/D-SUB2)

Adjusts the bright portions of the video input signal.

ANALOG OFFSET (D-SUB1[RGB]/D-SUB2)

Adjusts the dark portions of the video input signal.

3D-NR (AV input)

Reduce the noise of playback images on video.

Setting a higher level reduces more noise. However, it may cause blurring on an image.

MPEG-NR (AV input)

Reduce block noise caused by digital compression.

3D-Y/C (D-SUB1[VIDEO])

Specify whether to perform 3-dimension Y/C separation.

If dot interference or cross-color is occurring in fast-motion scenes, selecting "OFF" may improve the image quality.

RGB INPUT RANGE (HDMI[PC]/HDMI[AV]/D-SUB1[RGB]/D-SUB2/DisplayPort)

Sets the RGB input signal range. When using HDMI or DisplayPort set to AUTO, the RGB input signal range is detected automatically. Use AUTO normally.

If the RGB input signal range cannot be set appropriately even when using AUTO, set according to the image. When the setting is different, images will be displayed with washed out blacks and compressed gradients.

ACTIVE CONTRAST (AV input)

Automatically adjusts the contrast according to the image.

(In PIP mode, the main side setting is reflected in the image.)

The adjustment operation may not be smooth depending on the image. In this case select OFF.

DISPLAY COLOR PATTERN

Displays a color pattern. Can be displayed while the menu screen is displayed, so you can refer to the pattern while adjusting the image.

OFFNo pattern display.

WHITE.....White single color pattern display.

RED.....Red single color pattern display.

GREENGreen single color pattern display.

BLUEBlue single color pattern display.

USERRed/green/blue mixed color pattern display. When USER is selected, set each color's level.

RESET

Resets the values of the PICTURE menu items to the factory preset values.

Select "ON" and then press .

■AUDIO**TREBLE**

Adjusts the volume of treble-level sound.

BASS

Adjusts the volume of bass-level sound.





BALANCE

Adjusts the balance of the audio sound between right and left.

RESET

Resets the values of the AUDIO menu items to the factory preset values.
Select "ON" and then press .

■SETUP**DATE/TIME SETTING**

Set the date and time. Press  or  to select the date and time, and press  or  to change the numerical values.
Set the date in "Month/Day/Year" order.
Set the time on a 12-hour basis. (Factory default)

DATE/TIME FORMAT

Sets the date/time display format.
DATEMM/DD/YYYY, DD/MM/YYYY, YYYY/MM/DD
(YYYY: Year, MM: Month, DD: Day)
TIMESelect 12- or 24-hour time.

SCHEDULE (See page 37.)

You can turn the power on/off and change the screen brightness at a specified time.

LANGUAGE

Sets the display language for the menu screen.

INPUT SELECT**HDMI1/HDMI2/HDMI3**

Select the input mode to be used in HDMI1, HDMI2 and HDMI3 input terminals.

D-SUB1

Select the input mode to be used in D-Sub1 input terminal. Select SET after selecting the input mode, and then press .

HDMI AUTO VIEW

When ON is selected, the screen size is adjusted automatically according to the screen size control signal included in the video signal input from the AV HDMI input terminal.

HOT PLUG CONTROL

Sets whether to use hot plug control for the HDMI1, HDMI2, and HDMI3 input terminals.

INPUT MODE NAME

For each terminal, you can change the input mode name that is displayed during input mode selection and display.

AUDIO SELECT

Selects the terminal used to input audio signals in each input mode.

AUDIO OPTION**SPEAKER SELECT**

Selects the speaker to be used.

AUDIO OUTPUT

Sets the volume of sound output from the audio output terminals.
When set to VARIABLE 2, sound will not be output from the built-in speaker or the external speaker terminal.
VARIABLE1 You can adjust the volume using VOLUME.
VARIABLE2 You can adjust the volume using VOLUME.
FIXED Fixes the sounds.

AUDIO INPUT LEVEL 1/2

Selects the maximum audio input level of the audio input 1, 2 terminals.

MONAURAL AUDIO

Outputs audio signals as monaural.

Menu Items

TOUCH INPUT SELECT

These settings enable use of the touch panel according to input mode selection.

BOTTOM USB

Sets the input mode for use of the touch panel, which is connected to the USB port at the bottom of the monitor.

In the landscape orientation, select the terminal into which the video signal of the computer connected to the USB 1 port will be input. When BOTTOM INPUT TERM. is selected and the input mode is DisplayPort, HDMI1, or D-SUB1, the touch panel can be used with the computer connected to the USB 1 port.

In the portrait orientation, select the terminal into which the video signal of the computer connected to the USB 2 port will be input. When BOTTOM INPUT TERM. is selected and the input mode is HDMI2, HDMI3, or D-SUB2, the touch panel can be used with the computer connected to the USB 2 port.

When “-“ is selected, the touch panel cannot be used.

SIDE USB

Sets the input mode for use of the touch panel, which is connected to the USB port at the side of the monitor.

In the landscape orientation, select the terminal into which the video signal of the computer connected to the USB 2 port will be input. When SIDE INPUT TERM. is selected and the input mode is HDMI2, HDMI3, or D-SUB2, the touch panel can be used with the computer connected to the USB 2 port.

In the portrait orientation, select the terminal into which the video signal of the computer connected to the USB 1 port will be input. When SIDE INPUT TERM. is selected and the input mode is DisplayPort, HDMI1, or D-SUB1, the touch panel can be used with the computer connected to the USB 1 port.

When “-“ is selected, the touch panel cannot be used.

START INPUT MODE

You can set the input mode that will be in effect when the power is turned on.

When this is set to LAST INPUT MODE, the input mode when the power was last turned off will appear.

* When NO SIGNAL AUTO INPUT SEL is ON and there is no input signal in the set input mode, the input mode will change to the input mode that has an input signal.

COMMUNICATION SETTING

RS-232C/LAN SELECT

Selects the method with which to control the monitor from the computer.

BAUD RATE

Selects the communication speed used for RS-232C communication.

LAN SETUP

Configures the settings to control the monitor from the computer via LAN. (See page 51.)

■MONITOR**MONITOR**

Select the installation direction of the monitor.

LANDSCAPELandscape orientation

PORTRAITPortrait orientation

OSD H-POSITION

Adjusts the horizontal display position of menu screen.

OSD V-POSITION

Adjusts the vertical display position of menu screen.

STANDBY MODE

When STANDARD is selected, startup time from standby mode is reduced. Note, however that, more power will be consumed in standby mode.

When LOW POWER is selected, current consumption is reduced while the monitor is in standby mode. Note, however, that the startup time from standby mode becomes longer.

When LOW POWER is set, RS-232C/LAN control are not possible in standby mode.

OFF IF NO OPERATION

Determines whether or not to set the monitor to go into standby mode when there is no operation from the remote control unit, RS-232C commands, or LAN for over 4 hours.

POWER ON DELAY

If POWER ON DELAY is set to ON, you can delay the screen display after the monitor is turned on. When ON is selected, set the delay time with INTERVAL (interval can be set up to 60 seconds in units of 1 second).

When this function is activated, the power LED flashes (at approx. 0.5 second interval) in green.

SELF ADJUST

On a D-SUB1[RGB]/D-SUB2 screen, specify whether to perform screen adjustment automatically or not.

When ON is selected, the screen is automatically adjusted when its resolution is 800 x 600 or higher and the timing of input signals changes. "ADJUSTING" appears on the screen during the adjustment.

If SELF ADJUST is set to ON, set the time it takes to start the SELF ADJUST function in START TIMING.

For images with black edges, etc., depending on the signal, adjustment may not be possible. In this case select OFF. (Perform manual adjustment of the screen.)

TOUCH PANEL**TOUCH OUTPUT INVALID DISP.**

TOUCH OUTPUT INVALID ICON Sets whether the TOUCH OUTPUT INVALID icon is displayed when touch action is disabled.

CHANGE DISPLAY POSITION..... Sets the display position of the TOUCH OUTPUT INVALID icon.

TOUCH OPERATION MODE

Select the touch mode.

AUTO Automatically switches between MOUSE MODE and MULTI-TOUCH MODE.

MOUSE MODE Touch information is output as mouse information.

MULTI-TOUCH MODE Touch information is output as digitizer information.

* If Touch Panel Settings Tool is installed on your computer, set with the Touch Panel Settings Tool.

* The touch panel must be connected in order to configure this setting.

TOUCH PANEL MODE (PC input)

When the resolution is 1920 x 1080, setting this to ON improves touch panel tracking.

When two screens are displayed, or when V-POS or V-SIZE is adjusted on the SCREEN menu, the screen may become distorted. In this event, set to OFF.

Menu Items

■ PIP/PbyP

PIP MODES

Sets the display method.

OFFDisplays one screen.

PIPDisplays a sub screen inside a main screen.

PbyPDisplays a main screen and a sub screen in a line.

PbyP2Displays a main screen which measures 1280 pixels in the longest direction and a sub screen in a line.

PIP SIZE

Sets the size of the sub screen in PIP mode.

PIP H-POS

Adjusts the horizontal position of the sub screen in PIP mode.

PIP V-POS

Adjusts the vertical position of the sub screen in PIP mode.

PIP BLEND

In PIP mode, use this menu item to display the sub screen transparently.

PIP SOURCE

Selects the input signal of the sub screen in PIP, PbyP, or PbyP2 mode.

SOUND CHANGE

Sets the sound which is output in PIP, PbyP, or PbyP2 mode.

If the main screen is displayed as a full screen by the AUTO OFF function, the sound for the main screen is output even when the sound for the sub screen is specified.

MAIN POS

Sets the position of the main screen in PbyP or PbyP2 mode.

PbyP2 POS

Sets the position of the sub screen in PbyP2 mode.

AUTO OFF

Sets the display method when no signals for the sub screen are input in PIP, PbyP, or PbyP2 mode.

MANUAL.....Displays a main screen and a black sub screen.

AUTO.....Displays the main screen as a full screen.

■ OTHERS

SCREEN MOTION

PATTERN

Residual images are reduced by moving the screen.

OFF SCREEN MOTION function is disabled.

PATTERN1 The whole screen moves vertically and horizontally.

PATTERN2 A black screen spreads from the bottom of the screen and then shrinks to the bottom of the screen. If the monitor is installed in the portrait orientation, a black screen spreads from the right end of the screen and then shrinks to the right end of the screen.

PATTERN3 A black bar moves from the left end to the right end of the screen. If the monitor is installed in the portrait orientation, a black bar moves from the top to the bottom of the screen.

PATTERN4 Black screens appear from both the top and bottom of the screen, and the displayed image is compressed into the central field. If the monitor is installed in the portrait orientation, the screen is compressed from the left and right ends.



MOTION TIME 1

Specify a time period (operating interval) until SCREEN MOTION starts.

MOTION TIME 2

Specify a time period during which SCREEN MOTION operates (time period during which the screen will move).

POWER MANAGEMENT

POWER MANAGEMENT determines whether or not to switch modes from no signal to the input signal waiting mode.

CONNECT AUTO INPUT SELECT

Sets whether the input into the input terminal automatically changes when a video signal is input into that terminal.

(With some input signals, the input may not change.)

NO SIGNAL AUTO INPUT SEL.

Specify whether to change inputs automatically. When ON is selected and no signal is present in the selected input mode, the monitor automatically changes the selected mode to another mode where a video signal is present.

When there are video signals in multiple input modes, switching takes place according to the order of priority set in AUTO INPUT SELECT PRIORITY.

AUTO INPUT SELECT PRIORITY

Sets the order of input terminal priority for NO SIGNAL AUTO INPUT SEL..

Input does not change automatically for terminals without a priority setting.

LOGO SCREEN

Sets whether or not to display the logo screen.

INPUT SIGNAL (D-SUB1[RGB]/D-SUB2)

If the resolution of the computer is one of the following, make a selection from the following options.

480 LINES AUTO, 640x480 or 848x480

768 LINES AUTO, 1024x768, 1280x768, or 1360x768

1050 LINES 1400x1050 or 1680x1050

ZOOM2 SPECIAL SETTING (See page 36.)

SCAN MODE (AV input)

Sets the scan mode used for AV mode input.

MODE1 Over-scan display

MODE2 Under-scan display

MODE3 Under-scan display when the input signal is 1080i/p. Otherwise, over-scan display

* Even when MODE1 is selected, under-scan display is used when the input signal is 1080i/p and the screen size is Dot by Dot.

COLOR SYSTEM (D-SUB1[VIDEO])

Select the color system of the AV equipment which is connected to D-sub1 input terminal. (AUTO / PAL / PAL-60 / SECAM / NTSC3.58 / NTSC4.43)

When AUTO is selected, the color system is automatically set according to the input signal.

TIPS

- When WHITE BALANCE is set to THRU, BLACK LEVEL, CONTRAST, TINT, COLORS, RGB INPUT RANGE, GAMMA and COPY TO USER cannot be set.
- If COLOR MODE is set to sRGB, the following items cannot be set.
WHITE BALANCE, PRESET, USER, COPY TO USER, and GAMMA
- When the COLOR MODE is set to VIVID or HIGH ILLUMINANCE, GAMMA can not be adjusted.
- STANDBY MODE cannot be set to LOW POWER when SCHEDULE is effective.
- When displaying the color pattern, it is possible to adjust certain items of the PICTURE menu.
Non-adjustable items cannot be selected.

■Dual screen display

You can display two screens simultaneously.
Set this function with "PIP MODES" in the PIP/PbyP menu.

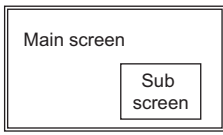
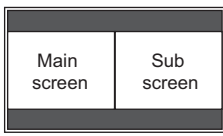
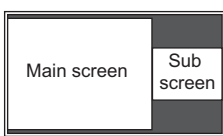
PIP		A sub screen is displayed inside a main screen.
PbyP		A main screen and a sub screen are displayed in a line.
PbyP2		Displays a main screen which measures 1280 pixels in the longest direction and a sub screen in a line.

- * The currently selected input signal is displayed on the main screen.
- * The following combinations are available for display:
DisplayPort - D-SUB1, D-SUB2
HDMI1, HDMI2, HDMI3 - D-SUB1, D-SUB2

TIPS

- You might infringe on a copyright of the author which is protected by copyright law when you display the images of the computer screen and television/VCR simultaneously for profit-making or to show the image to the public.
- The screen size for dual-screen display is the same as the screen size for single-screen display. The Dot by Dot screen is displayed in NORMAL size except when it is set as the PIP main screen.
- When dual-screen display is selected, the SCREEN MOTION function is disabled.
- When dual-screen display is selected, the CONNECT AUTO INPUT SELECT function and NO SIGNAL AUTO INPUT SEL. function are disabled.
- When dual-screen display is selected, the INPUT SELECT options cannot be set.
- When dual-screen display is selected, the AUDIO menu cannot be set.
- When an interlaced signal (1080i, 480i, video) is input to the sub screen, horizontal lines may flicker. If this happens, display the image on the main screen.
- Touch operation cannot be used in the sub screen.

■ZOOM2 SPECIAL SETTING

If you connect a laptop computer with any of the following screen resolutions and black bands appear around the screen, set ZOOM2 SPECIAL SETTING of INPUT SIGNAL on the OTHERS menu to ON and then select ZOOM2 in the SIZE setting.

This displays the area inside the black band.

Laptop computer resolution	Corresponding signal*1
1280x800	1280x1024, 1280x960, 1400x1050*2
1280x600	1280x720
1024x600	1024x768

*1: This setting is effective only when the screen resolution, including the black band, is one of the resolutions listed above.

*2: Use the automatic screen adjustment.

■ SCHEDULE

You can set the time to switch the monitor on and off.
Set this function with "SCHEDULE" in the SETUP menu. (See page 31.)

SCHEDULE		<D-SUB1[RGB]>					
No.	(1)	(2)	(3)	(4)	(5)	(6)	
	POWER	DAY OF THE WEEK	TIME	INPUT	BRIGHT		
1	-	--	--	--	--	--	
2	-	--	--	--	--	--	
3	-	--	--	--	--	--	
4	-	--	--	--	--	--	
5	-	--	--	--	--	--	
6	-	--	--	--	--	--	
7	-	--	--	--	--	--	
8	-	--	--	--	--	--	

OK...[ENTER] CANCEL...[RETURN]
1920 x 1080 V: 60 Hz H: 67.5 kHz

- Press or to select the SCHEDULE number, and press .
- Set the SCHEDULE. (See the description below.)
Press or to select items, and press or to change the setting.
- Press .
SCHEDULE becomes effective.

(1)

- : SCHEDULE effective
- : SCHEDULE not effective

(2) POWER

ON : Switches the monitor on at the specified time.
OFF : Switches the monitor off at the specified time and puts the monitor in standby mode.

(3) DAY OF THE WEEK

Specifies the day of the week to execute the SCHEDULE.

0: ONLY ONCE

Executes the SCHEDULE once on the specified day.

Specify the day of the week to execute the SCHEDULE.

1: EVERY WEEK

Executes the SCHEDULE on the specified day of the week every week. Specify the day of the week to execute the SCHEDULE.

Periodic setting such as "Monday through Friday" is also possible.

2: EVERY DAY

Executes the SCHEDULE every day regardless of the day of the week.

(4) TIME

Specifies the time to execute the SCHEDULE.

Set the time on a 12-hour basis. (Factory default)

Can be entered as 24-hour time using the TIME setting in DATE/TIME FORMAT.

(5) INPUT

Specifies the input mode at power-on. If not specified, the START INPUT MODE setting will apply. By factory default, the input that was active when the power was last turned off will appear. Input modes displayed on HDMI1, HDMI2, HDMI3 and D-SUB1 will depend upon the INPUT SELECT settings.

(6) BRIGHT

Sets the brightness when changing the screen brightness at a specified time.

! Caution

- Do not switch off the main power after setting the SCHEDULE.
- Specify the correct date and time. (See page 31.) SCHEDULE does not function unless the date and time are specified.
- Check regularly that the set date and time are correct.
- When STANDBY MODE is LOW POWER, SCHEDULE cannot be set.
- When a temperature abnormality occurs and the backlight brightness is reduced, the brightness is not changed even if a schedule set to BRIGHT is executed.







TIPS

- Up to 8 SCHEDULE items can be registered.
- Setting the SCHEDULE flashes the power LED alternately in red and orange in standby mode.
- A SCHEDULE that has a large number has precedence over that of a small number when schedules overlap.

Adjustments for PC screen display

■Automatic adjustment

When you use D-SUB1 or D-SUB2 to display a computer screen for the first time, or when you change the setting of the computer, use the automatic screen adjustment.

1. **Switch the input to D-SUB1 or to D-SUB2 and display the adjustment pattern.** (See the description below.)
2. Press  and use  or  to display the SCREEN menu.
3. Press  and select "AUTO".
4. Press .
5. Press  to close the menu screen.

TIPS

- If the screen cannot be adjusted properly with one automatic adjustment, repeat the automatic adjustment two or three times. Try manual adjustment if necessary.

■Screen display for adjustment

Before making adjustments in the SCREEN menu or PICTURE menu, display an image to brighten the entire screen. If you are using a Windows PC, use the adjustment pattern on the supplied CD-ROM.

Opening the adjustment pattern

The following example is performed in Windows 7.

1. **Load the supplied CD-ROM into the computer's CD-ROM drive.**
2. **Open [CD Drive] in [Computer].**
3. **Double-click [Adj_uty.exe] in the [Monitor] folder.**
The adjustment pattern will appear.
Adjust the screen automatically or manually.

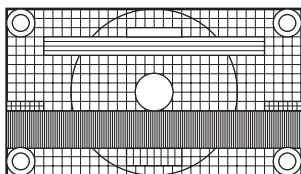





4. **When adjustment is finished, press the [Esc] on the computer's keyboard to quit the adjustment program.**
5. **Eject the CD-ROM from the CD-ROM drive.**

TIPS

- If the display mode on the computer you are using is 65,000 colors, the color levels in the color pattern may appear differently or grayscale may appear to be colored. (This is due to the specifications of the input signal and is not a malfunction.)

Initialization (Reset)/Functional Restriction Setting (FUNCTION)

You can return the settings to their factory-preset values and restrict operations.

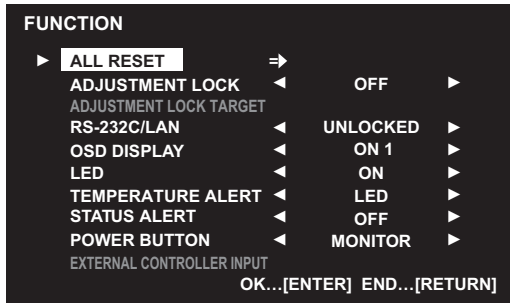

1. Hold  down until "F" appears in the upper left corner of the screen.
2. While "F" appears, press , , ,  in that order.



3. Select and set the items.

ALL RESET

Resets the settings to the factory default settings.

Press , select the resetting method, and then press .

ALL RESET1Resets all the settings to the factory default settings.

ALL RESET2Returns all settings to the factory default settings except for the following items:
LAN SETUP, RS-232C/LAN SELECT, BAUD RATE, NETWORK, MAIL, SERVICE & SUPPORT, and SNMP (See page 32, and pages 55 to 58.)

ADJUSTMENT LOCK

You can disable operations on the monitor and the remote control unit that use buttons.

OFF ... Enables operation.

ON 1 ..Disables all operations other than turning power on/off and FUNCTION.

ON 2 .. Only the FUNCTION operation is enabled.
Disables all operations other than FUNCTION (not even power on/off).
When STANDBY MODE is set to LOW POWER, ON 2 cannot be set.

ADJUSTMENT LOCK TARGET

Sets the target to prohibit operation of with ADJUSTMENT LOCK.

REMOTE CONTROL..... Prohibits remote control operation

MONITOR BUTTONS ... Prohibits monitor button operation

BOTH..... Prohibits remote control and monitor button operation

RS-232C/LAN

Specifies whether to allow control via RS-232C or LAN (see pages 40 and 51).

OSD DISPLAY

Shows/hides the menu, modes and messages.

The FUNCTION screen cannot be hidden.

ON 1 Shows all menus, modes and messages.

ON 2 Hides messages automatically displayed by the display. Shows messages during operation.

OFF Hides all menus, modes and messages.

LED

Specifies whether to light the power LED.

TEMPERATURE ALERT

Selects the notification method for an abnormal temperature.

OFF Do not notify about an abnormal temperature.

OSD & LED .. When an abnormal temperature is detected, the power LED flashes in red and green alternately and the screen displays a message: TEMPERATURE.

LED..... When an abnormal temperature is detected, the power LED flashes in red and green alternately.

STATUS ALERT

Selects the notification method for a hardware error.

OFF Do not notify about the error.

OSD & LED .. When a hardware error is detected, the power LED flashes in red and the screen displays a message: STATUS [xxxx].

LED..... When a hardware error is detected, the power LED flashes in red.

POWER BUTTON

Normally, leave this setting as MONITOR.

When using an optional part, if instruction appears, change the setting accordingly.

EXTERNAL CONTROLLER INPUT

Normally, you do not need to change this setting.

When using an optional part, if instruction appears, change the setting accordingly.

4. Press  to return to the normal screen.

TIPS

- When both abnormal temperature and hardware error are detected, the hardware error notification overrides.
- If TEMPERATURE ALERT or STATUS ALERT is set to OSD&LED, alert messages will appear even if the OSD DISPLAY is set to ON 2 or OFF.
- If TEMPERATURE ALERT or STATUS ALERT is set to LED or OSD & LED, the LED lights even if the LED function is set to OFF.

Controlling the Monitor with a PC (RS-232C)

You can control this monitor from a PC via RS-232C (COM port) on the PC.

TIPS

- To control the monitor via RS-232C, set RS-232C/LAN SELECT to RS-232C.
- When STANDBY MODE is set to LOW POWER, control is not possible in standby mode.
- You cannot use RS-232C and LAN control simultaneously.

PC connection

Connect the RS-232C conversion cable (supplied) to the RS-232C input terminal on the monitor. Connect the RS-232C conversion cable (supplied) to the COM port (RS-232C port) on your computer with an RS-232 cable (straight).

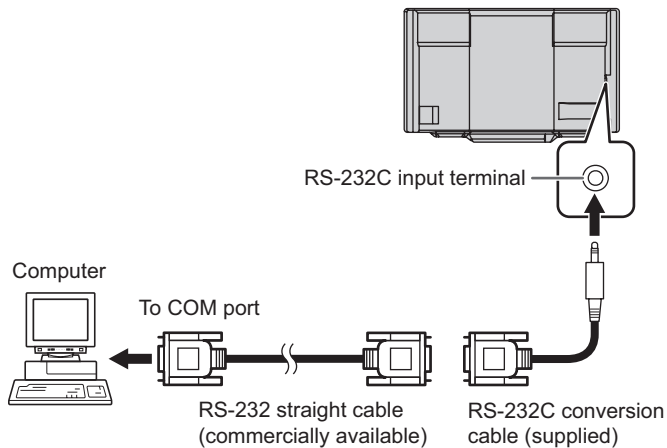

Communication conditions

Set the RS-232C communication settings on the PC to match the monitor's communication settings as follows:

Baud rate	*
Data length	8 bits
Parity bit	None

Stop bit	1 bit
Flow control	None

* Set to the same baud rate as the BAUD RATE setting of SETUP menu. (Initial setting: 38400 bps)

Communication procedure

■ Command format

When a command is sent from the PC to the monitor, the monitor operates according to the received command and sends a response message to the PC.

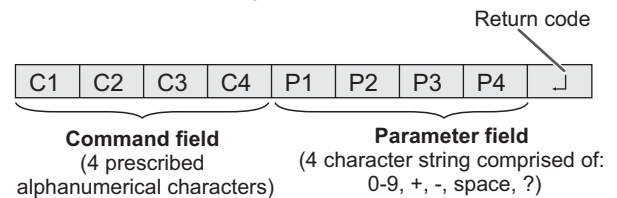

Example: VOLM0030
VOLM _ _ 30

- * Be sure to input 4 characters for the parameter. Pad with spaces (" ") if necessary. (" " is a return code (0DH, 0AH or 0DH))
Wrong : VOLM30
Right : VOLM _ _ 30

When inputting a negative value, specify a numerical value in three digits.

Example: AUTR-005

Do not use spaces for MPOS, DATE, and SC01 through SC08. Specify parameters using a specified number of characters.

Example: MPOS010097

If a command has "R" listed for "DIRECTION" in the "RS-232C command table" on page 43, the current value can be returned by using "?" as the parameter.

Example:

VOLM ? ? ? ? ← From PC to monitor (How much is current volume setting?).

30 ← From monitor to PC (Current volume setting: 30).

■Response code format

When a command has been executed correctly

O	K	↵
---	---	---

Return code
(0DH, 0AH)

A response is returned after a command is executed.

When a command has not been executed

E	R	R	↵
---	---	---	---

Return code
(0DH, 0AH)

TIPS

- “ERR” is returned when there is no relevant command or when the command cannot be used in the current state of the monitor.
- If communication has not been established for reasons such as a bad connection between the PC and monitor, nothing is returned (not even ERR).
- “ERR” may be returned when a command cannot be received correctly due to interference from the surrounding environment.
Please ensure that the system or software retries the command if this occurs.

If execution of the command is taking some time

W	A	I	T	↵
---	---	---	---	---

Return code
(0DH, 0AH)

When the following commands are used, “WAIT” is returned. In this case, a value will be returned if you wait a while. Do not send any command during this period.

- Commands which return WAIT:
RSET, INPS, ASNC, WIDE, PXSL, POWR, AGIN, MWIN, MWIP, MWPP

When control via RS-232C is locked (see page 39)

L	O	C	K	E	D	↵
---	---	---	---	---	---	---

Return code
(0DH, 0AH)

When RS-232C/LAN SELECT is set to LAN

U	N	S	E	L	E	C	T	E	D	↵
---	---	---	---	---	---	---	---	---	---	---

Return code
(0DH, 0AH)

■Communication interval

- After OK or ERR is returned, you must send the following commands.
To set a timeout for the command response, specify 10 seconds or longer.
- Provide an interval of 100 ms or more between the command response and the transmission of the next command.

VOLM0020
OK

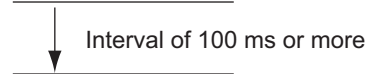

INPS0001
WAIT
OK

TIPS

- When executing ALL RESET, set the timeout period to 30 seconds or longer.
- When turning the power on while the POWER ON DELAY function is in use, set the timeout period to the POWER ON DELAY period + 10 seconds or longer.

Setting of the GAMMA user data

■ To transfer the GAMMA user data

Use the user data transfer commands (UGRW, UGGW and UGBW). For each of the R, G and B colors, divide the total 512 pieces of user data into 16 blocks, and transfer 32 pieces of data with each command.

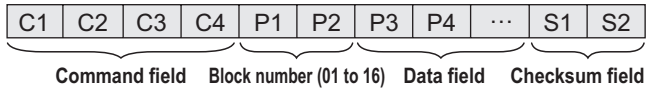

Example: To transfer the data of block 1 (0 to 31 levels) of red (R) data

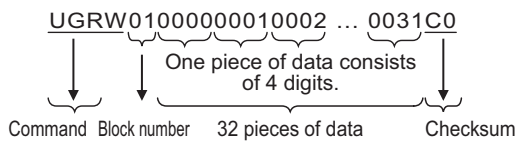

- * If data is less than 4 digits, add a "0" (zero) to make it 4 digits.
- * The checksum field is the character string (ASCII) data of lower-order one byte which indicates the sum of the block number and 32 pieces of data in hexadecimal (0 to F).

■ Saving the GAMMA user data

Use the user data save command (UGSV) to save the transferred user data in the monitor.

If the data is not saved, it will be cleared when:

- The main power switch is off
- STANDBY MODE is LOW POWER and the monitor enters standby mode

■ Activating the GAMMA user data

To activate the transferred user data, select USER for GAMMA of the PICTURE menu, or send the corresponding RS-232C command.

■ Checking the GAMMA user data

Use the user data read commands (UGRR, UGGR and UGBR) to return 512 pieces of user data for each of the R, G and B colors. Divide the data into 16 blocks and return 32 pieces of data with each command. The value to be returned is not the value stored in the monitor, but the value in the temporary memory for display. (These values are the same when the user data save command (UGSV) above has been sent.)

TIPS

- The user data is not initialized by RESET of the PICTURE menu. To initialize the user data, use ALL RESET of the FUNCTION menu.
The GAMMA user data initialize command (UGRS) allows the initialization of the user data only.

RS-232C command table

How to read the command table

- Command: Command field (See page 40.)
- Direction: W When the "Parameter" is set in the parameter field (see page 40), the command functions as described under "Control/Response Contents".
 R The returned value indicated under "Reply" can be obtained by setting "???" or "___?" in the parameter field (see page 40).
- Parameter: Parameter field (See page 40.)
- Reply: Response (Returned value)
- * : When "STANDBY MODE" is set to "STANDARD":
 "o" : Indicates a command which can be used in standby mode or when the power is on.
 "-" : Indicates a command which can be used when the power is on. Cannot be used in standby mode.
- When "STANDBY MODE" is set to "LOW POWER":
 "o/-" : Indicates a command which can be used when the power is on. Cannot be used in standby mode.

Power control/Input mode selection

Function	Command	Direction	Parameter	Reply	Control/Response contents	*		
POWER CONTROL	POWR	W	0		Switches to standby mode.			
			1		Enters the power ON state.			
		R		0	Standby mode			
				1	Normal mode			
		2	Input signal waiting mode					
INPUT MODE SELECTION	INPS	W	0		Toggle change for input mode. Terminals not selected in INPUT SELECT cannot be selected.	o		
			2		D-SUB1[RGB] "ERR" when other than RGB is selected for D-SUB1 of INPUT SELECT.			
			3		D-SUB1[COMPONENT] "ERR" when other than COMPONENT is selected for D-SUB1 of INPUT SELECT.			
			4		D-SUB1[VIDEO] "ERR" when other than VIDEO is selected for D-SUB1 of INPUT SELECT.			
			9		HDMI1[AV] "ERR" when PC is selected for HDMI1 of INPUT SELECT.			
			10		HDMI1[PC] "ERR" when AV is selected for HDMI1 of INPUT SELECT.			
			12		HDMI2[AV] "ERR" when PC is selected for HDMI2 of INPUT SELECT.			
			13		HDMI2[PC] "ERR" when AV is selected for HDMI2 of INPUT SELECT.			
			14		DisplayPort			
			16		D-SUB2			
			17		HDMI3[AV] "ERR" when PC is selected for HDMI3 of INPUT SELECT.			
			18		HDMI3[PC] "ERR" when AV is selected for HDMI3 of INPUT SELECT.			
				R			2	D-SUB1[RGB]
					3		D-SUB1[COMPONENT]	
					4		D-SUB1[VIDEO]	
					9		HDMI1[AV]	
					10		HDMI1[PC]	
					12		HDMI2[AV]	
				13	HDMI2[PC]			
				14	DisplayPort			
		16	D-SUB2					
		17	HDMI3[AV]					
		18	HDMI3[PC]					

Controlling the Monitor with a PC (RS-232C)

SCREEN menu

Function		Command	Direction	Parameter	Reply	Control/Response contents	*
AUTO		ASNC	W	1		When the input mode is D-SUB1[RGB], D-SUB2.	
CLOCK		CLCK	WR	0-1200	0-1200	When the input mode is D-SUB1[RGB], D-SUB2. Varies depending on the signal.	
PHASE		PHSE	WR	0-63	0-63	When the input mode is D-SUB1[RGB], D-SUB2.	
POSITIONING	POSITION OF THE LONGEST DIRECTION	HPOS	WR	0-100	0-100	0-800 on D-SUB1[RGB], D-SUB2. Varies depending on the signal.	
	POSITION OF THE SHORTEST DIRECTION	VPOS	WR	0-100	0-100	0-200 on D-SUB1[RGB], D-SUB2. Varies depending on the signal.	
SIZE	SIZE OF THE LONGEST DIRECTION	HSIZ	WR	0-100	0-100		
	SIZE OF THE SHORTEST DIRECTION	VSIZ	WR	0-100	0-100		
RESOLUTION	LONGEST DIRECTION RESOLUTION	HRES	WR	300-1920	300-1920	When the input mode is D-SUB1[RGB], D-SUB2. Only even numbers are valid for parameters. Varies depending on the signal.	
	SHORTEST DIRECTION RESOLUTION	VRES	WR	200-1200	200-1200		
RESET		ARST	W	1			

PICTURE menu

Function		Command	Direction	Parameter	Reply	Control/Response contents	*	
BRIGHT		VLMP	WR	0-31	0-31			
CONTRAST		CONT	WR	0-60	0-60			
BLACK LEVEL		BLVL	WR	0-60	0-60			
TINT		TINT	WR	0-60	0-60			
COLORS		COLR	WR	0-60	0-60			
SHARPNESS		SHRP	WR	0-24	0-24			
COLOR ADJUSTMENT	COLOR MODE	BMOD	WR	0	0	STD		
				2	2	VIVID		
				3	3	sRGB (When the input mode is PC)		
				4	4	HIGH ILLUMINANCE		
	WHITE BALANCE	THRU	CTMP	WR	0	0	PC input	
					1-28	1-28	From 1: approximately 3,000K to 15: approximately 10,000K (500K steps) 16: approximately 5,600K, 17: approximately 9,300K, 18: approximately 3,200K From 19: approximately 10,500K to 28: approximately 15,000K (500K steps)	
		PRESET						
		USER			99	99		
		R-CONTRAST	CRTR	WR	0-256	0-256	"ERR" when CTMP is not set to 99.	
		G-CONTRAST	CRTG	WR	0-256	0-256		
		B-CONTRAST	CRTB	WR	0-256	0-256		
	R-OFFSET	OFSR	WR	-127-127	-127-127			
	G-OFFSET	OFSG	WR	-127-127	-127-127			
	B-OFFSET	OFSB	WR	-127-127	-127-127			
COPY TO USER		CPTU	W	0		Copies a preset value to the user setting.		
GAMMA		GAMM	WR	0-2	0-2	0: 1.8, 1: 2.2, 2: 2.4 (during PC input) 0: LIGHT 2, 2: DARK (during AV input)		
				4-6	4-6	4: USER, 5: 2.0, 6: STD (during PC input) 4: USER, 5: LIGHT 1, 6: STD (during AV input)		
FLESH TONE (AV input)		FLES	WR	0-2	0-2	0: OFF, 1: LOW, 2: HIGH		
C.M.S.-HUE (AV input)		CMHR	WR	-10-10	-10-10	R "ERR" when other than OFF is selected for FLESH TONE.		
		CMHY				Y "ERR" when other than OFF is selected for FLESH TONE.		
		CMHG				G "ERR" when other than OFF is selected for FLESH TONE.		
		CMHC				C "ERR" when other than OFF is selected for FLESH TONE.		
		CMHB				B "ERR" when other than OFF is selected for FLESH TONE.		
		CMHM				M "ERR" when other than OFF is selected for FLESH TONE.		
		CRST	W	1		Resets the hue. "ERR" when other than OFF is selected for FLESH TONE.		
C.M.S.-SATURATION (AV input)		CMSR	WR	-10-10	-10-10	R "ERR" when other than OFF is selected for FLESH TONE.		
		CMSY				Y "ERR" when other than OFF is selected for FLESH TONE.		
		CMSG				G "ERR" when other than OFF is selected for FLESH TONE.		
		CMSC				C "ERR" when other than OFF is selected for FLESH TONE.		
		CMSB				B "ERR" when other than OFF is selected for FLESH TONE.		
		CMSM				M "ERR" when other than OFF is selected for FLESH TONE.		
		CRST	W	2		Resets the saturation. "ERR" when other than OFF is selected for FLESH TONE.		
C.M.S.-VALUE (AV input)		CMVR	WR	-10-10	-10-10	R "ERR" when other than OFF is selected for FLESH TONE.		
		CMVY				Y "ERR" when other than OFF is selected for FLESH TONE.		
		CMVG				G "ERR" when other than OFF is selected for FLESH TONE.		
		CMVC				C "ERR" when other than OFF is selected for FLESH TONE.		
		CMVB				B "ERR" when other than OFF is selected for FLESH TONE.		
		CMVM				M "ERR" when other than OFF is selected for FLESH TONE.		
		CRST	W	3		Resets the brightness. "ERR" when other than OFF is selected for FLESH TONE.		

Controlling the Monitor with a PC (RS-232C)

	Function	Command	Direction	Parameter	Reply	Control/Response contents	*
ADVANCED	AUTO	AGIN	W	1		When the input mode is D-SUB1[RGB], D-SUB2.	-
	ANALOG GAIN	ANGA	WR	0-127	0-127	When the input mode is D-SUB1[RGB], D-SUB2.	○
	ANALOG OFFSET	ANOF	WR	0-127	0-127	When the input mode is D-SUB1[RGB], D-SUB2.	
	3D-NR (AV input)	TDNR	WR	0-2	0-2	0: OFF, 1: LOW, 2: HIGH	
	MPEG-NR (AV input)	MPNR	WR	0-1	0-1	0: OFF, 1: ON	
	3D-Y/C	YCSP	WR	0-1	0-1	0: OFF, 1: ON (When the input mode is D-SUB1[VIDEO])	
	RGB INPUT RANGE (HDMI1[AV])	AHDR	WR	0-2	0-2	0: AUTO, 1: FULL, 2: LIMITED	
	RGB INPUT RANGE (HDMI1[PC])	PHDR	WR	0-2	0-2	0: AUTO, 1: FULL, 2: LIMITED	
	RGB INPUT RANGE (HDMI2[AV])	AH2R	WR	0-2	0-2	0: AUTO, 1: FULL, 2: LIMITED	
	RGB INPUT RANGE (HDMI2[PC])	PH2R	WR	0-2	0-2	0: AUTO, 1: FULL, 2: LIMITED	
	RGB INPUT RANGE (HDMI3[AV])	AH3R	WR	0-2	0-2	0: AUTO, 1: FULL, 2: LIMITED	
	RGB INPUT RANGE (HDMI3[PC])	PH3R	WR	0-2	0-2	0: AUTO, 1: FULL, 2: LIMITED	
	RGB INPUT RANGE (D-SUB1[RGB])	PDSR	WR	1-2	1-2	1: FULL, 2: LIMITED	
	RGB INPUT RANGE (D-SUB2)	PD2R	WR	1-2	1-2	1: FULL, 2: LIMITED	
	RGB INPUT RANGE (DisplayPort)	PDPR	WR	0-2	0-2	0: AUTO, 1: FULL, 2: LIMITED	
	ACTIVE CONTRAST (AV input)	ACNT	WR	0-1	0-1	0: OFF, 1: ON	
	DISPLAY COLOR PATTERN	PTDF	WR	0	0	No pattern display.	
				1	1	White single color pattern display.	
				2	2	Red single color pattern display.	
				3	3	Green single color pattern display.	
4				4	Blue single color pattern display.		
99				99	Red/green/blue mixed color pattern display. Set each color's level with PTDR, PTDG, PTDB.		
DISPLAY COLOR PATTERN (R)	PTDR	WR	0-15	0-15	"ERR" when PTDF is not set to 99.		
DISPLAY COLOR PATTERN (G)	PTDG	WR	0-15	0-15			
DISPLAY COLOR PATTERN (B)	PTDB	WR	0-15	0-15			
RESET	ARST	W	2			-	

AUDIO menu

	Function	Command	Direction	Parameter	Reply	Control/Response contents	*
	TREBLE	AUTR	WR	-5-5	-5-5		○
	BASS	AUBS	WR	-5-5	-5-5		
	BALANCE	AUBL	WR	-10-10	-10-10		
	RESET	ARST	W	3			-

Controlling the Monitor with a PC (RS-232C)

SETUP menu

Function	Command	Direction	Parameter	Reply	Control/Response contents	*	
DATE/TIME SETTING	DATE	WR	AABBCCDDEE	AABBCCDDEE	AA: Year, BB: Month, CC: Day, DD: Hour, EE: Minute		
DATE DISPLAY FORMAT	DTFT	WR	0-2	0-2	0: YYYY/MM/DD, 1: MM/DD/YYYY, 2: DD/MM/YYYY YYYY: Year, MM: Month, DD: Day		
TIME DISPLAY FORMAT	TMFT	WR	0-1	0-1	0: 24-HOUR TIME, 1: 12-HOUR TIME		
SCHEDULE	SC01- SC08	WR	ABCDEFGHIJGH	ABCDEFGHIJGH	Schedule of a specified number A: Schedule 0= Not effective, 1 = Effective B: Power 0 = OFF, 1 = ON C: Day of the week 1 0 = Only once, 1 = Every week, 2 = Every day D: Day of the week 2* 0 = Sunday, 1 = Monday through 6 = Saturday, 9 = Not exist E: Day of the week 3* 0 = Sunday, 1 = Monday through 6 = Saturday, 9 = Not exist F: Hour 00-23 G: Minute 00-59 H: Input 0 = Not specified, 1 = HDMI1, 2 = HDMI2, 3 = HDMI3, 4 = D-SUB1, 5 = D-SUB2, 6 = DisplayPort *If "Every day" is selected for "Day of the week 1", "ERR" occurs when other than 9 is selected. "ERR" when LOW POWER is selected for STANDBY MODE.		
SCHEDULE BRIGHTNESS	SB01- SB08	WR	0-31	0-31	Screen brightness to change		
			99	99	Disable brightness setting		
LANGUAGE	LANG	WR	14	14	ENGLISH		
			1	1	DEUTSCH		
			2	2	FRANÇAIS		
			3	3	ITALIANO		
			4	4	ESPAÑOL		
			5	5	РУССКИЙ		
			6	6	日本語		
INPUT SELECT	HDMI1	HDSL	WR	0-1	0-1	0:PC, 1:AV	
	HDMI2	H2SL	WR	0-1	0-1	0:PC, 1:AV	
	HDMI3	H3SL	WR	0-1	0-1	0:PC, 1:AV	
	D-SUB1	SLDS	WR	0-2	0-2	0:RGB, 1:COMPONENT, 2:VIDEO	
	HDMI1 AUTO VIEW	HDAW	WR	0-1	0-1	0: OFF, 1: ON	
	HDMI2 AUTO VIEW	H2AW	WR	0-1	0-1	0: OFF, 1: ON	
	HDMI3 AUTO VIEW	H3AW	WR	0-1	0-1	0: OFF, 1: ON	
	HOT PLUG CONTROL (HDMI1)	HPCH	WR	0-1	0-1	0: OFF, 1: ON	
	HOT PLUG CONTROL (HDMI2)	HPH2	WR	0-1	0-1	0: OFF, 1: ON	
	HOT PLUG CONTROL (HDMI3)	HPH3	WR	0-1	0-1	0: OFF, 1: ON	
INPUT MODE NAME	DisplayPort	INDP	WR	0-30	0-30	0: NO SETTING, 1: PC1, 2:PC2, 3: PC3, 4: TV, 5: VIDEO, 6: DVD, 7: HDD, 8: DVR, 9: BD, 10: CAMERA, 11: DOCUMENT CAMERA, 12: VIDEO CAMERA, 13: VIDEO CONFERENCE, 14: WIRELESS, 15: STB, 16: CONTROLLER, 17: COMPOSITE, 18: COMPONENT, 19: RGB, 20: INPUT1, 21: INPUT2, 22: INPUT3, 23: INPUT4, 24: INPUT5, 25: INPUT6, 26: SATELLITE, 27: CABLE, 28: CAMCORDER, 29: TABLET, 30: SURVEILLANCE CAM.	
	HDMI1	INH1					
	HDMI2	INH2					
	HDMI3	INH3					
	D-SUB1	IND1					
	D-SUB2	IND2					
AUDIO SELECT	DisplayPort	ASDI	WR	1-3	1-3	1: AUDIO1, 2: AUDIO2, 3: DisplayPort	
	HDMI1[PC]	ASHP	WR	0-2	0-2	0: HDMI, 1: AUDIO1, 2: AUDIO2	
	HDMI1[AV]	ASHA	WR	0-2	0-2	0: HDMI, 1: AUDIO1, 2: AUDIO2	
	HDMI2[PC]	AH2P	WR	0-2	0-2	0: HDMI, 1: AUDIO1, 2: AUDIO2	
	HDMI2[AV]	AH2A	WR	0-2	0-2	0: HDMI, 1: AUDIO1, 2: AUDIO2	
	HDMI3[PC]	AH3P	WR	0-2	0-2	0: HDMI, 1: AUDIO1, 2: AUDIO2	
	HDMI3[AV]	AH3A	WR	0-2	0-2	0: HDMI, 1: AUDIO1, 2: AUDIO2	
	D-SUB1[RGB]	ASAP	WR	1-2	1-2	1: AUDIO1, 2: AUDIO2	
	D-SUB1[COMPONENT]	ASC2	WR	1-2	1-2	1: AUDIO1, 2: AUDIO2	
	D-SUB1[VIDEO]	ASV2	WR	1-2	1-2	1: AUDIO1, 2: AUDIO2	
	D-SUB2	ASA2	WR	1-2	1-2	1: AUDIO1, 2: AUDIO2	
AUDIO OPTION	SPEAKER SELECT	SPSL	WR	0-1	0-1	0: Internal speaker, 1: External speaker	
	AUDIO OUTPUT	AOUT	WR	0-2	0-2	0: VARIABLE1, 1: FIXED, 2: VARIABLE2	
	AUDIO INPUT LEVEL1	AIVP	WR	0-1	0-1	0: 1.0Vrms, 1: 0.5Vrms	
	AUDIO INPUT LEVEL2	AIV2	WR	0-1	0-1	0: 1.0Vrms, 1: 0.5Vrms	
	MONAURAL AUDIO	MONO	WR	0-1	0-1	0: OFF, 1: ON	
TOUCH INPUT SELECT	BOTTOM USB (Long side)	USCB	WR	0-7	0-7	0: INVALID, 1: BOTTOM INPUT TERM. (Long side), 2: DisplayPort, 3: HDMI1, 4: HDMI2, 5: HDMI3, 6: D-SUB1, 7: D-SUB2	
	SIDE USB (Short side)	USCS	WR	0-7	0-7	0: INVALID, 1: SIDE INPUT TERM. (Short side), 2: DisplayPort, 3: HDMI1, 4: HDMI2, 5: HDMI3, 6: D-SUB1, 7: D-SUB2	
START INPUT MODE	SUIM	WR	1-5, 7-8	1-5, 7-8	1: LAST INPUT MODE, 2: DisplayPort, 3: HDMI1, 4: HDMI2, 5: HDMI3, 7: D-SUB1, 8: D-SUB2		
COMMUNICATION SETTING	RS-232C/LAN SELECT	CTLS	WR	0-1	0-1	0: RS-232C 1: LAN	
	BAUD RATE	BAUD	WR	0-2	0-2	0: 9600bps, 1: 19200bps, 2: 38400bps	

Controlling the Monitor with a PC (RS-232C)

MONITOR menu

Function	Command	Direction	Parameter	Reply	Control/Response contents	*
MONITOR	STDR	WR	0-1	0-1	0: LANDSCAPE, 1: PORTRAIT	
OSD H-POSITION	OSDH	WR	0-100	0-100		
OSD V-POSITION	OSDV	WR	0-100	0-100		
STANDBY MODE	STBM	WR	0-1	0-1	0: STANDARD, 1: LOW POWER When ADJUSTMENT LOCK is set to ON2, LOW POWER cannot be selected (ERR). "ERR" when SCHEDULE is effective.	
OFF IF NO OPERATION	ATOF	WR	0-1	0-1	0: OFF, 1: ON	
POWER ON DELAY	SET	PODS	0-1	0-1	0: OFF, 1: ON	○
	INTERVAL	PWOD	0-60	0-60	0: OFF, 1-60 seconds	
SELF ADJUST	SELF ADJUST	AADJ	0-1	0-1	0: OFF, 1: ON	
	START TIMING	AADD	10-200	10-200	10: 1 second through 200: 20 seconds	
TOUCH OUTPUT INVALID DISP.	TOUCH OUTPUT INVALID ICON	TOPI	0-1	0-1	0: OFF, 1: ON	
	CHANGE DISPLAY POSITION	TOIP	0-3	0-3	0: UPPER RIGHT, 1: UPPER LEFT, 2: LOWER RIGHT, 3: LOWER LEFT	
TOUCH OPERATION MODE	TOMD	WR	0-2	0-2	0: AUTO, 1: MULTI-TOUCH MODE, 2: MOUSE MODE "ERR" when the touch panel is not connected. "ERR" when Touch Panel Settings Tool is installed in the computer connected to the touch panel.	-
TOUCH PANEL MODE	GMDP	WR	0-1	0-1	0: OFF, 1: ON (When the input mode is PC)	○

PIP/PbyP menu

Function	Command	Direction	Parameter	Reply	Control/Response contents	*
PIP MODES	MWIN	WR	0-3	0-3	0: OFF, 1: PIP, 2: PbyP, 3: PbyP2	
PIP SIZE	MPSZ	WR	1-64	1-64		
PIP POS	THE LONGEST DIRECTION	MHPS	0-100	0-100		
	THE SHORTEST DIRECTION	MVPS	0-100	0-100		
PIP POS LD+SD BATCH	MPOS	W	0-100,0-100		Specify the position in MPOSxxxxyy format. (xxx: Longer side, yyy: Shorter side position)	
		R		0-100,0-100	Returns a response in (xxx,yyy) format. (xxx: Longer side, yyy: Shorter side position)	
PIP BLEND	MWBL	WR	0-15	0-15		
PIP SOURCE	MWIP	WR	2	2	D-SUB1[RGB]	○
			3	3	D-SUB1[COMPONENT]	
			4	4	D-SUB1[VIDEO]	
			9	9	HDMI1[AV]	
			10	10	HDMI1[PC]	
			12	12	HDMI2[AV]	
			13	13	HDMI2[PC]	
			14	14	DisplayPort	
			16	16	D-SUB2	
17	17	HDMI3[AV]				
18	18	HDMI3[PC]				
SOUND CHANGE	MWAD	WR	1-2	1-2	1: MAIN, 2: SUB	
MAIN POS (Main screen)	MWPP	WR	0-1	0-1	0: POS1, 1: POS2	
PbyP2 POS (Sub screen)	MW2P	WR	0-2	0-2	0: POS1, 1: POS2, 2: POS3	
AUTO OFF	MOFF	WR	0-1	0-1	0: MANUAL, 1: AUTO	

Controlling the Monitor with a PC (RS-232C)

OTHERS menu

Function	Command	Direction	Parameter	Reply	Control/Response contents	*	
SCREEN MOTION	PATTERN	SCSV	WR	0-4	0-4	0: OFF, 1-4: PATTERN1-4	
	MOTION TIME1	MTIM	WR	0-20	0-20		
	MOTION TIME2 (PATTERN1)	MINT	WR	10-990	10-990	Per 10 seconds	
	MOTION TIME2 (PATTERN2-4)	MINT	WR	5-20	5-20	Per second	
POWER MANAGEMENT (PC)	PMNG	WR	0-1	0-1	0: OFF, 1: ON	○	
POWER MANAGEMENT (AV)	PMVA	WR	0-1	0-1	0: OFF, 1: ON		
CONNECT AUTO INPUT SELECT	AICO	WR	0-1	0-1	0: OFF, 1: ON		
NO SIGNAL AUTO INPUT SEL.	AINO	WR	0-1	0-1	0: OFF, 1: ON		
AUTO INPUT SELECT PRIORITY	DisplayPort	APDP	WR	0-6	0-6		0: Not selected by auto input selection, 1-6: Priority setting • "ERR" when OFF is selected for NO SIGNAL AUTO INPUT SEL.. • All input terminals cannot be set to 0 simultaneously.
	HDMI1	APH1					
	HDMI2	APH2					
	HDMI3	APH3					
	D-SUB1	APD1					
	D-SUB2	APD2					
LOGO SCREEN	BTSC	WR	0-1	0-1	0: OFF, 1: ON	-	
INPUT RESOLUTION (PC)	RESOLUTION CHECK	PXCK	R		-		Returns current resolution in the form of hhh, vvv.
	PIXEL SETTING (D-SUB1[RGB], D-SUB2)	PXSL	WR	1	1		768) 1360 x 768
				2	2		768) 1280 x 768
				3	3		768) 1024 x 768
				5	5		480) 848 x 480
				6	6		480) 640 x 480
				7	7		1050) 1680 x 1050
				8	8		1050) 1400 x 1050
				9	9		768) AUTO
				10	10	480) AUTO	
INPUT RESOLUTION (AV)	RESO	R		-	480i, 480p, 1080i, 720p, 1080p, etc.		
ZOOM2 SPECIAL SETTING (D-SUB1[RGB], D-SUB2)	Z2SP	WR	0-1	0-1	0: OFF, 1: ON	○	
SCAN MODE	SCAN	WR	0-2	0-2	0: MODE1, 1: MODE2, 2: MODE3 (When the input mode is AV)		
COLOR SYSTEM	CSYS	WR	0-5	0-5	0: AUTO, 1: PAL, 2: PAL-60, 3: SECAM, 4: NTSC3.58, 5: NTSC4.43		

Controlling the Monitor with a PC (RS-232C)

Initialization/Functional Restriction Setting (FUNCTION) menu

Function	Command	Direction	Parameter	Reply	Control/Response contents	*
ALL RESET	RSET	W	0-1		0: ALL RESET 1, 1: ALL RESET 2	-
ADJUSTMENT LOCK	ALCK	WR	0-2	0-2	0: OFF, 1:ON1, 2:ON2 When STANDBY MODE is set to LOW POWER, ON2 cannot be selected (ERR).	○
ADJUSTMENT LOCK TARGET	ALTG	WR	0-2	0-2	0: REMOTE CONTROL, 1: MONITOR BUTTONS, 2: BOTH "ERR" when OFF is selected for ADJUSTMENT LOCK.	
OSD DISPLAY	LOSD	WR	0-2	0-2	0: ON1, 1: OFF, 2: ON2	
LED	OFLD	WR	0-1	0-1	0: ON, 1: OFF	
TEMPERATURE ALERT	TALT	WR	0-2	0-2	0: OFF, 1: OSD & LED, 2: LED	
STATUS ALERT	SALT	WR	0-2	0-2	0: OFF, 1: OSD & LED, 2: LED	
POWER BUTTON	PBTN	WR	0-1	0-1	0: MONITOR, 1: EXT. CONTROLLER	
EXTERNAL CONTROLLER INPUT	PCIP	WR	0-5	0-5	0: D-SUB1, 1: D-SUB2, 2: DisplayPort, 3: HDMI1, 4: HDMI2, 5: HDMI3 "ERR" when MONITOR is selected for POWER BUTTON.	

Others

Function	Command	Direction	Parameter	Reply	Control/Response contents	*
SCREEN SIZE (PC)	WIDE	WR	0-5	0-5	0: Toggle to change size, 1: WIDE, 2: NORMAL, 3: Dot by Dot, 4: ZOOM1, 5: ZOOM2	○
SCREEN SIZE (AV)	WIDE	WR	0-5	0-5	0: Toggle to change size, 1: WIDE, 2: ZOOM1, 3: ZOOM2, 4: NORMAL, 5: Dot by Dot	
VOLUME	VOLM	WR	0-31	0-31		
MUTE	MUTE	WR	0-1	0-1	0: OFF, 1: ON	-
INFORMATION	MODEL	INF1	R	Value		○
	SERIAL NO	SRNO	R	Value		
TEMPERATURE SENSOR	DSTA	R		0	Internal temperature normal	
				1	Internal temperature abnormal has occurred and the monitor is in standby mode	
				2	Internal temperature abnormal occurred (To delete the information of temperature abnormal, turn off the main power.)	
				3	Internal temperature abnormal has occurred and backlight brightness is dimmed	
				4	Temperature sensor abnormal	
TEMPERATURE ACQUISITION	ERRT	R		Value	Returns the temperature at the temperature sensors. Indicates a temperature sensor abnormality when "126" is returned.	
CAUSE OF LAST STANDBY MODE	STCA	W	0		Initialization	
		R			0	
					1	Standby mode by POWER button
					2	Main power off by the main power switch
					3	Standby mode by RS-232C or LAN
					4	Input signal waiting mode by No Signal
					6	Standby mode by abnormal temperature
					8	Standby mode by SCHEDULE setting
20	Standby mode by OFF IF NO OPERATION setting					
Touch operation valid/invalid	TPEN	WR	0-1	0-1	0: Invalid, 1: Valid "ERR" when TOUCH INPUT SELECT is set to INVALID or the touch panel is not connected.	-

Controlling the Monitor with a PC (RS-232C)

Commands for setting of the GAMMA user data

Function	Command	Direction	Parameter	Reply	Control/Response contents	*
RED GAMMA DATA TRANSFER	UGRW	W	aa:xxxx ... xxxxcc (xxxx: 32 pieces) aa: 01-16 xxxx: 0000-1023 cc: 00-FF		aa: Block number xxxx: 32 pieces of user data cc: Checksum (ASCII data) of the block number and user data	
GREEN GAMMA DATA TRANSFER	UGGW	W				
BLUE GAMMA DATA TRANSFER	UGBW	W				
RED GAMMA DATA READ	UGRR	W	1-16	xxxx ... xxxx	xxxx: User data of 32 pieces	○
GREEN GAMMA DATA READ	UGGR	W	1-16	(xxxx: 32 pieces)		
BLUE GAMMA DATA READ	UGBR	W	1-16	xxxx: 0000-1023		
USER DATA INITIALIZE	UGRS	W	0		Initialize the user data.	
USER DATA SAVE	UGSV	W	0		Save the user data in the monitor.	

Controlling the Monitor with a PC (LAN)

Your monitor can be connected to a LAN allowing you to control it from a PC on the LAN.

You can also configure the monitor to send e-mail notification when it has a problem.

The connection requires a commercially available LAN cable (UTP cable, Category 5, straight through).

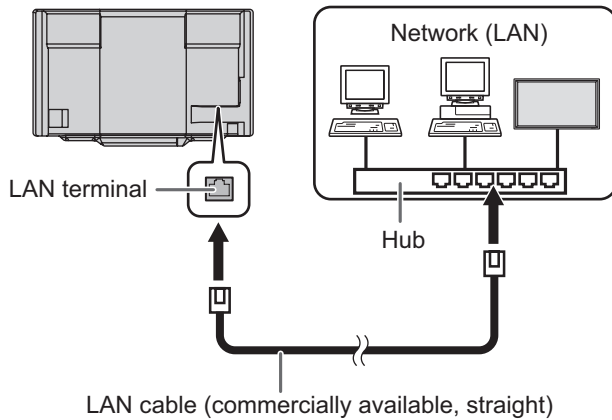

TIPS

- You must assign an IP address to the monitor by following the procedures in "Settings to connect to a LAN". (See the description on the right.)
- Your PC must be installed with Internet Explorer (version 7.0 or later).
 - Version 7, 8, 9, 10 or 11 of Internet Explorer is recommended.
- When STANDBY MODE is set to LOW POWER, control is not possible in standby mode.
- To control the monitor via LAN, set RS-232C/LAN SELECT to LAN. (See page 32.)
- You cannot use RS-232C and LAN control simultaneously.

Initializing personal information

- Personal information such as e-mail addresses can be registered in the monitor. Before transferring or disposing of the monitor, initialize all settings by selecting ALL RESET 1. (See page 39.) Note that ALL RESET 2 will not initialize e-mail addresses and other settings.

Settings to connect to a LAN

Set the monitor's IP address and subnet mask to match the settings of your LAN.

These settings can be made on either the monitor or a PC connected to the monitor.

The settings depend on the configuration of your LAN. Ask your LAN administrator for details.

■ To set on the monitor

Set RS-232C/LAN SELECT of COMMUNICATION SETTING on the SETUP menu to LAN, and then set the LAN SETUP options. (See page 32.)

After setting each item, select SET and press .

DHCP CLIENT

If your LAN has a DHCP server and you wish to obtain an address automatically, change this setting to ON.

To set the address manually, set this to OFF.

IP ADDRESS

If the DHCP CLIENT is set to OFF, specify an IP address.

Press or to select items, and press or to change the values.

SUBNET MASK

If the DHCP CLIENT is set to OFF, specify the subnet mask.

Press or to select items, and press or to change the values.

DEFAULT GATEWAY

If the DHCP CLIENT is set to OFF, specify the default gateway.

If you are not using a gateway, specify "0.0.0.0".

Press or to select items, and press or to change the values.

RESET

Resets the values of the LAN settings to the factory preset values.

Select ON and then press .

Controlling the Monitor with a PC (LAN)

■ To set from a PC

When the monitor is connected to a PC, LAN settings can be configured via PC.

Set up process

- (1) Connect your monitor to a PC
- (2) Specify the PC's IP address
- (3) Configure the monitor's LAN settings

(1) Connecting your monitor to a PC

Connect a commercially available crossover LAN cable (UPT cable, Category 5) to the LAN port on the PC and this monitor.

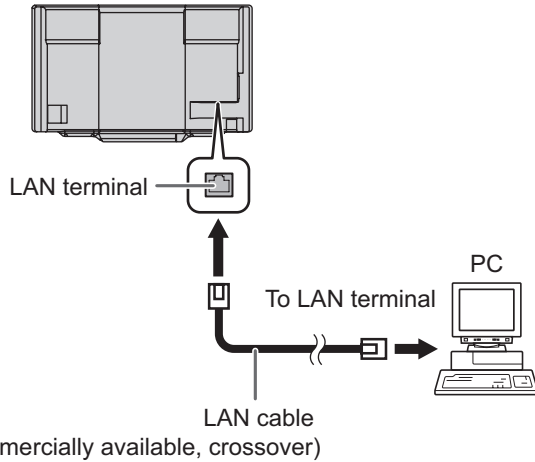

(2) Specifying the PC's IP address

To configure the monitor's LAN settings, you must temporarily change the settings on the PC.

This explanation is based on Windows 7.

1. Log on to the PC with an administrator account.
2. Click [Start], and then click "Control Panel".
3. Click "View network status and tasks" in "Network and Internet".
In "Classic View", click "Network and Sharing Center".
4. Click "Local Area Connection" and then "Properties".
5. Click "Internet Protocol Version 4 (TCP/IPv4)" and then "Properties".
6. Make a note of the current IP address, subnet mask, and default gateway settings.

Make sure you write this information now as you will be changing the IP address, subnet mask, and default gateway settings back to these settings afterwards.

7. Temporarily change the IP address and subnet mask.
To access the monitor as it is shipped from the factory, set as follows.

- IP Address: 192.168.150.1
- Subnet Mask: 255.255.255.0
- Default Gateway: (leave blank)

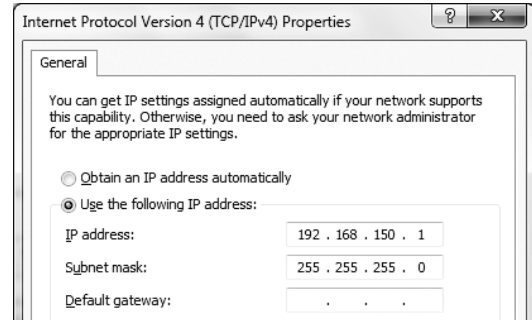

8. Click [OK] and then reboot the PC.

TIPS

- This monitor is factory preset as shown below.
(When DHCP CLIENT is set to OFF)
- | | |
|-----------------|-----------------|
| IP Address | : 192.168.150.2 |
| Subnet Mask | : 255.255.255.0 |
| Default Gateway | : 0.0.0.0 |

(3) Configuring the monitor's LAN settings

Access the monitor using Internet Explorer.

Controlling the monitor

1. Turn the power ON to the monitor.
2. Set RS-232C/LAN SELECT of COMMUNICATION SETTING on the SETUP menu to LAN.
3. Set DHCP CLIENT of LAN SETUP of COMMUNICATION SETTING on the SETUP menu to OFF.

PC operation

4. Launch Internet Explorer, in the "Address" box type "http://192.168.150.2/" and press the Enter key.



5. Click on "LAN SETUP" under NETWORK.

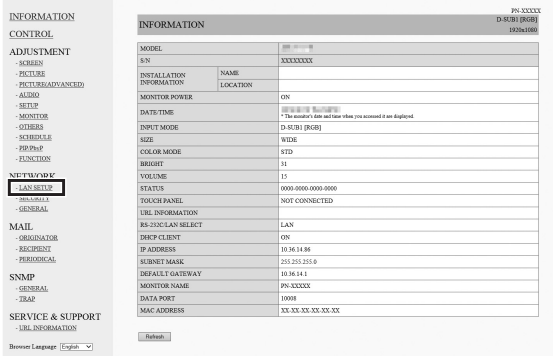

6. Specify the "DHCP CLIENT", "IP ADDRESS", etc.

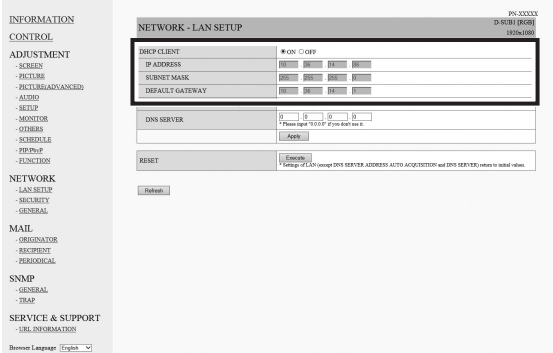

DHCP CLIENT

If your LAN has a DHCP server and you wish to obtain an address automatically, change this setting to "ON". To set the address manually, set this to "OFF".

IP ADDRESS

If the DHCP CLIENT is set to "OFF", specify an IP address.

SUBNET MASK

If the DHCP CLIENT is set to "OFF", specify the subnet mask.

DEFAULT GATEWAY

If the DHCP CLIENT is set to "OFF", specify the default gateway. If you are not using a default gateway, specify "0.0.0.0".

- When the setting is changed, click [Apply].
- Check the message and click [OK].
- Exit Internet Explorer.
- Restore the PC's IP address jotted in Step 6, "(2) Specifying the PC's IP address".
- Connect the monitor and the PC to the LAN.

TIPS

- Wait 10 seconds after clicking [OK] before proceeding.
- When operating using the remote control unit or similar, click [Refresh].

Controlling with a PC

TIPS

- For security, set a USER NAME and PASSWORD. (See page 55.)

Basic operation

You use Internet Explorer on a PC on the LAN to control the monitor.

- Launch Internet Explorer on the PC.
- In the "Address" box, type "http://" followed by your monitor's IP address followed by "/", then press the Enter key. You can confirm the IP address with the DISPLAY function.



When prompted to enter a user name and password, type the user name and password that you specified in the security settings (see page 55.), and click [OK].

- You can check, control, and change the monitor's status and settings by clicking the menu items on the left side of the screen.

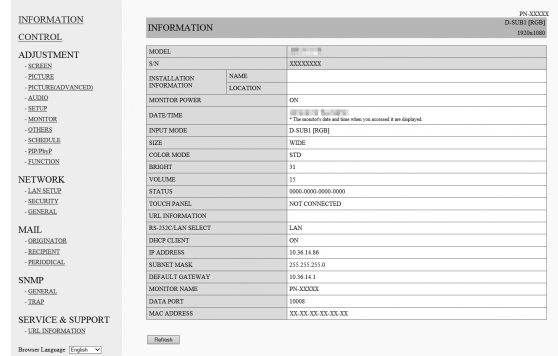

- If you see an [Apply] button next to a setting, click it after you change that setting.

TIPS

- See pages 54 to 58 for details on each setting.
- If you click [Refresh] before the screen finishes updating the current display, the "Server Busy Error" will appear. Wait for a moment before operating your monitor again.
- You cannot operate the monitor while it is warming up.
- If "DHCP CLIENT" is set to "ON", press ^{DISPLAY} on the remote control unit two times and then check the monitor's IP address.

Controlling the Monitor with a PC (LAN)

■ INFORMATION

Information about this monitor appears.

INFORMATION		PN: XXXXX
MODEL	SH-1100	D-RECI (P00B)
S/N	XXXXXXXX	01060100
INSTALLATION INFORMATION	NAME	
	LOCATION	
MONITOR POWER	ON	
DATE TIME	* To monitor time and date when you connect it on display.	
INPUT MODE	D.SUB (P00B)	
SIZE	WIDE	
COLOR MODE	STD	
BRIGHT	31	
VOLUME	15	
STATUS	0000-0000-0000-0000	
TOUCH PANEL	NOT CONNECTED	
URL INFORMATION		
RS-232C LAN SELECT	LAN	
DHCP CLIENT	ON	
IP ADDRESS	10.16.14.86	
SUBNET MASK	255.255.255.0	
DEFAULT GATEWAY	10.16.1.1	
MONITOR NAME	PN-XXXXX	
DATA PORT	100H	
MAC ADDRESS	XX.XX.XX.XX.XX.XX	

■ CONTROL

You can control the operations corresponding to the buttons (POWER INPUT SIZE) on the remote control unit. (See page 25.)

CONTROL		PN: XXXXX
MONITOR POWER	<input checked="" type="radio"/> ON <input type="radio"/> OFF	D-RECI (P00B)
INPUT MODE	(SH) (P00B)	01060100
SIZE	(W) (P00B)	
COLOR MODE	(STD) (P00B)	
BRIGHT	(31) (P00B)	
VOLUME	(15) (P00B)	
MUTE	<input type="radio"/> ON <input checked="" type="radio"/> OFF	

■ ADJUSTMENT

You can adjust these settings which are also available on the monitor's menu.

- SCREEN (See page 28.)
- PICTURE (See pages 29 to 30.)
- AUDIO (See page 31.)
- SETUP (See pages 31 to 32.)
- MONITOR (See page 33.)
- SCHEDULE (See page 37.)
- PIP/PbyP (See page 34.)
- OTHERS (See page 35.)
- FUNCTION (See page 39.)

ADJUSTMENT - SCREEN		PN: XXXXX
AUTO	[Enable]	D-RECI (P00B)
CLOCK	(SH) (P00B)	01060100
PHASE	(SH) (P00B)	
H-POS	(L12) (P00B)	
V-POS	(31) (P00B)	
H-SIZE	(SH) (P00B)	
V-SIZE	(SH) (P00B)	
H-RESOLUTION	(SH) (P00B)	
V-RESOLUTION	(SH) (P00B)	
RESET	[Enable]	

TIPS

- After changing DISPLAY COLOR PATTERN to OFF in PICTURE menu, click [Refresh] to correctly retrieve the status of the monitor.

TIPS

- In standby mode, Power ON is the operation available.

■ NETWORK (LAN SETUP)

This screen allows you to set the settings necessary when the monitor is connected to a LAN.

DHCP CLIENT

If your LAN has a DHCP server and you wish to obtain an address automatically, change this setting to ON. To set the address manually, set this to OFF.

IP ADDRESS

If the DHCP CLIENT is set to OFF, specify an IP address.

SUBNET MASK

If the DHCP CLIENT is set to OFF, specify the subnet mask.

DEFAULT GATEWAY

If the DHCP CLIENT is set to OFF, specify the default gateway.

If you are not using a default gateway, specify "0.0.0.0".

DNS SERVER ADDRESS AUTO ACQUISITION

If the DHCP CLIENT is set to ON, specify whether or not to automatically obtain the DNS server address.

DNS SERVER

Specify the DNS server address if the DHCP CLIENT is set to OFF or the DNS SERVER ADDRESS AUTO ACQUISITION is set to OFF.

If you are not using a DNS server, specify "0.0.0.0".

RESET

Clicking [Execute] returns all of the LAN SETUP settings to the factory-preset values except for the DNS SERVER ADDRESS AUTO ACQUISITION and DNS SERVER settings.

■ NETWORK (SECURITY)

This screen allows you to specify the security-related settings.

USER NAME / PASSWORD

Sets up a user name and password to restrict access to this monitor.

After entering a user name and password, click [Apply].

ACCEPT IP ADDRESS

You can limit access to this monitor by registering IP addresses of PCs that should have access.

To limit access, specify the option "From only specific IP addresses". Otherwise, to allow access from any PC, specify "All IP Addresses".

IP ADDRESS 1 to 3

If "ACCEPT IP ADDRESS" is set to "From only specific IP addresses", enter the IP addresses that you want to allow.

TIPS

- The USER NAME and PASSWORD can be up to 8 alphanumeric characters (hyphens and underscores allowed).
- To cancel the user name and/or password after it has been set, make the box empty and click [Apply].

Controlling the Monitor with a PC (LAN)

■ NETWORK (GENERAL)

This screen allows you to specify the general LAN settings.

MONITOR NAME

Specify a name for this monitor as it should appear on the Internet Explorer screen.

AUTO LOGOUT TIME

Specify the time (in minutes) to elapse before automatically disconnecting this monitor from the network. Specify in minutes from 1 to 65535. A value of '0' will disable this function.

DATA PORT

Specify the TCP port number to use for exchanging data with the monitor. Specify a value from 1025 to 65535.

SEARCH PORT

Specify the port number to use when searching for this monitor. Specify a value from 1025 to 65535.

INSTALLATION INFORMATION (NAME/LOCATION)

Specify the information to display for this monitor in the Internet Explorer window.

LINK MODE

Selects the link speed and duplex. Use AUTO normally.

TIPS

- The MONITOR NAME can be up to 16 alphanumeric characters or symbols.
- Enter up to 50 characters in the NAME field in the INSTALLATION INFORMATION.
- Enter up to 100 characters in the LOCATION field in the INSTALLATION INFORMATION.

■ MAIL (ORIGINATOR)

This screen allows you to configure the e-mail sent periodically or when the monitor has an error. The settings depend on the configuration of your LAN. Ask your LAN administrator for details.

SMTP SERVER

Specify the SMTP server address for sending e-mail. * When using a domain name, make sure to specify the DNS SERVER as well. (See page 55.)

SMTP PORT

If the "AUTHENTICATION" is "SMTP-AUTH", specify the port number.

ORIGINATOR E-MAIL ADDRESS

Specify the e-mail address for this monitor. This address becomes the e-mail address of the originator.

ORIGINATOR NAME

Specify the name for the originator. This name appears in the "Originator Name" field of the e-mail.

AUTHENTICATION

Specify the authentication method to use when sending e-mail.

POP SERVER

If the "AUTHENTICATION" method is "POP before SMTP", specify the POP server address.

ACCOUNT NAME / PASSWORD

If the "AUTHENTICATION" is "POP before SMTP" or "SMTP-AUTH", specify the account name and password to connect to the SMTP server.

TIPS

- You can enter up to 64 alphanumeric characters or symbols for the ORIGINATOR E-MAIL ADDRESS, ORIGINATOR NAME, ACCOUNT NAME, and PASSWORD.
- The SMTP SERVER and POP SERVER can be up to 64 characters. The following characters can be used: a-z, A-Z, 0-9, - , .

MAIL (RECIPIENT)

This screen allows you to specify the recipients of the e-mail sent periodically or when the monitor has an error.

MAIL - RECIPIENT

No.	RECIPIENT E-MAIL ADDRESSES <small>*MAX 64 characters</small>	PERIODICAL	TEMPERATURE	HARDWARE	CONFIRMATION
1		<input type="checkbox"/>	<input type="checkbox"/>	<input type="checkbox"/>	Test
2		<input type="checkbox"/>	<input type="checkbox"/>	<input type="checkbox"/>	Test
3		<input type="checkbox"/>	<input type="checkbox"/>	<input type="checkbox"/>	Test

Attach the log file to a TEMPERATURE/HARDWARE error e-mail.
*attach to log file to a PERIODICAL report e-mail.

DATE/TIME: 11-2015 THU 00:00
DESTINATION: No. 1
E-MAIL TRANSMISSION ERROR REPORT: TEMPERATURE

RECIPIENT E-MAIL ADDRESSES

Specify the e-mail addresses to send error notification e-mail to.

CONDITION

Specify the conditions to send mails.
When you check PERIODICAL, specify the date and time to send the mails in the PERIODICAL setting.

CONFIRMATION

Sends test e-mail.
This allows you to confirm that the e-mail settings are configured properly.

Attach the log file to a TEMPERATURE/HARDWARE error e-mail.

When this option is checked, a log is added to the mail which notifies a temperature or status error.

E-MAIL TRANSMISSION ERROR REPORT

A report of the latest e-mail transmission errors will be displayed.
The error report will be displayed when an e-mail transmission error occurs.
Also, the e-mail transmission errors will be cleared when ALL RESET1 is executed. (See page 39.)

TIPS

- The RECIPIENT E-MAIL ADDRESSES can be up to 64 alphanumeric characters or symbols.

MAIL (PERIODICAL)

When PERIODICAL for CONDITION of MAIL (RECIPIENT) is checked, set the date and time to send the mail.

MAIL - PERIODICAL

DAY OF THE WEEK: SUN MON TUE WED THU FRI SAT
*Please check the day of the week sending e-mail.

TIME: 1:00
2:00
3:00
4:00
*Please specify the time.

DATE/TIME: 11-2015 THU 00:00
DESTINATION: No. 1
E-MAIL TRANSMISSION ERROR REPORT: TEMPERATURE

DAY OF THE WEEK

Specify the day of the week to send the periodical mails.

TIME

Specify the time of the day to send the periodical mails.

! Caution

- Do not turn off the main power when you set to send the periodical mails.
- Specify the correct date and time. (See page 31.)
If the date and time settings are incorrect, the periodical mail is not sent properly.
- Regularly confirm that the specified date and time is correct.
- When LOW POWER is selected for STANDBY MODE, periodical mails will not be sent in standby mode.

[Advanced operation]**Command-based control**

You can control the monitor using RS-232C commands (see page 43) via terminal software and other appropriate applications.

In order to use this function, enable a connection to the monitor through Internet Explorer.

Read the manual for the terminal software for detailed instructions.

(1) Connect the PC to the monitor.

1. Specify the IP address and data port number and connect the PC to the monitor.
When connection has been established successfully, [␣Login:] is returned as response.
2. Send the user name set in the SECURITY settings (see page 55).
 - Send [User name] + [␣].
 - If the user name is not set, send [␣].
 - When the transmission is successful, [␣Password:] is returned as response.
3. Send the password set in the SECURITY settings (see page 55).
 - Send [Password] + [␣].
 - If the password is not set, send [␣].
 - When the transmission is successful, [OK ␣] is returned as response.

(2) Send commands to control the monitor.

- The commands used are the same as those for RS-232C. Refer to the communication procedure (see page 40) for operation.
- Usable commands are provided in the RS-232C command table (see page 43).

(3) Disconnect the connection with the monitor and quit the function.

1. Send [BYE␣].
When the transmission is successful, [goodbye] is returned and the connection is disconnected.

TIPS

- Connection is automatically disconnected when the time specified in AUTO LOGOUT TIME elapses over a no-communication period.

Troubleshooting

If you are experiencing any problem with your display, before calling for service, please review the following troubleshooting tips.

There is no picture or sound.

- Is the power cord disconnected? (See page 14.)
- Is the main power switch off? (See page 17.)
- Is the monitor in standby mode (the power LED illuminating in orange)? (See page 17.)
- Make sure correct input mode is selected. (See pages 24 to 25.)
- If any external equipment is connected, make sure the equipment is operating (playing back).

Remote control does not work.

- Are the batteries inserted with polarity (+,-) aligned? (See page 15.)
- Are the batteries exhausted?
- Point the remote control unit toward the monitor's remote control sensor. (See page 15.)
- Is the menu display hidden or is operation disabled? (See page 39.)

Sound from left and right speakers is reversed.

Sound is heard from only one side.

- Are audio cables connected properly? (See page 13.)
- Make sure audio cables for external speakers are connected properly: left and right cables may be reversed or one of the two cables may not be connected. (See page 13.)
- Check the setting of BALANCE for AUDIO menu. (See page 31.)

There is a picture but no sound.

- Is the sound muted?
- Make sure the volume is not set to minimum.
- Are audio cables connected properly?
- Is the setting of AUDIO SELECT on the SETUP menu correct? (See page 31.)
- Is the setting for SPEAKER SELECT of AUDIO OPTION on the SETUP menu correct? (See page 31.)

Unstable video.

- The signal may be incompatible.
- Try the automatic screen adjustment when D-SUB1[RGB] or D-SUB2 are used.
- If the top and bottom of the image are not horizontally aligned, set TOUCH PANEL MODE on the MONITOR menu to OFF.

The video from the HDMI input terminal does not appear properly.

- Is the setting for HDMI1/HDMI2/HDMI3 of INPUT SELECT on the SETUP menu correct? (See page 31.)
- Is the HDMI cable HDMI standard compliant? The monitor will not work with cables that are not standard compliant.
- Is the input signal compatible with this monitor? (See pages 64 to 65.)

The video from D-sub1 input terminal does not appear correctly.

- Is the setting for D-SUB1 of INPUT SELECT on the SETUP menu correct? (See page 31.)
- Is the input signal compatible with this monitor? (See page 64.)

The video from D-sub2 input terminal does not appear correctly.

- Is the input signal compatible with this monitor? (See page 64.)

The video from DisplayPort input terminal does not appear correctly.

- Is the input signal compatible with this monitor? (See page 64.)
- Is the DisplayPort cable DisplayPort standard compliant? The monitor will not work with cables that are not standard compliant.

Control buttons do not work.

There is no picture.

- Load noises from outside may be interfering with normal operation. Turn off the power and turn it on after waiting at least 5 seconds, and then check the operation.

The input mode changes automatically.

- When CONNECT AUTO INPUT SELECT is ON, the input mode automatically changes to that terminal when a video signal is input into the input terminal.
For this reason, the input mode may change when the computer wakes up from system standby.
- When the NO SIGNAL AUTO INPUT SEL. is ON and no signal is present in a selected input mode, the monitor automatically changes the selected mode to a mode where a video signal is present.
The input mode may change in the following cases:
 - When a computer is in standby mode.
 - When video play is stopped with a playback device.

The touch panel does not respond.

- Is the USB cable connected properly? (Touch Panel Settings Tool Operation Manual)
- Have Touch Panel Settings Tool and Touch Pen Utility been installed? (Touch Panel Settings Tool Operation Manual, Touch Pen Utility Operation Manual)
- Has the pen tip of the touch pen become worn? Replace the pen tip. (See page 20.)
- Is the battery inserted in the wrong orientation (+, -) in the touch pen? (See page 19.)
- Is the touch pen battery exhausted?
- Are touch pens that are supplied touch pens or optional PN-ZL03 used?
"CAPACITIVE" is indicated on touch pens that can be used with this monitor.





- If your finger is too dry, the screen may not respond.
- Do not touch the screen when the monitor power is turned on, it will lead to a malfunction. When this occurs, turn the monitor power off and then on.

Power LED flashes red.

“STATUS [xxxx]” appears in the corner of the screen.

- Hardware has a problem. Turn off the monitor and request repair from your SHARP dealer.
(When STATUS ALERT is set to OSD & LED. This varies depending on the setting.)

When “AUTO DIMMING” is displayed.

- When the internal temperature of the monitor rises excessively, the brightness of the backlight automatically decreases in order to prevent a further temperature rise. If you attempt to use   to adjust the brightness while the monitor is in this state, “AUTO DIMMING” is displayed and you cannot change the brightness.
- Remove the cause of the excessive temperature rise.

The monitor makes a cracking sound.

- You may occasionally hear a cracking sound from the monitor. This happens when the cabinet slightly expands and contracts according to change in temperature. This does not affect the monitor's performance.

The Power LED is flashing in red and green alternately.

When “TEMPERATURE” is displayed in the corner of the screen.

- When the internal temperature of the monitor rises excessively, the brightness of the backlight decreases automatically in order to prevent high-temperature-related problems. When this occurs, “TEMPERATURE” is displayed on the screen and the Power LED flashes red and green alternately. (When TEMPERATURE ALERT is set to OSD & LED. This varies depending on the setting.)
- If the internal temperature rises further, the monitor automatically enters standby mode. (The Power LED continues flashing red and green alternately.)
- Remove the cause of the excessive temperature rise.
 - If the monitor enters standby mode due to a rise in temperature, to return to normal display, turn the power switch off and then back on again. The monitor, however, will enter standby mode again if the cause of the temperature rise is not eliminated. (See page 7.)
 - Check whether the monitor is placed at a location where a quick rise in temperature is likely. Internal temperature rises quickly if the vents on the monitor are blocked.
 - Internal temperature rises quickly if dust accumulates inside the monitor or around the vents. Remove dust if possible. Ask SHARP dealer about removing internal dust.

Specifications

■Product Specifications

Model	PN-L803C	
LCD component	80" Class [80 inch (203.2cm) diagonal] TFT LCD	
Max. resolution	(pixels)	1920 x 1080
Max. colors	Approx. 1.06 billion colors	
Pixel pitch	0.923 mm (H) × 0.923 mm (V)	
Viewing angle	176° right/left/up/down (contrast ratio ≥ 10)	
Screen active area	inch (mm)	69-3/4 (W) x 39-1/4 (H) (1771.2 x 996.3)
Computer input signal	Analog RGB (0.7 Vp-p) [75 Ω], DisplayPort 1.1a	
Sync signal	Horizontal/vertical separate (TTL: positive/negative), Sync-on-green ^{*1} , Composite sync (TTL: positive/negative) ^{*1}	
Video color system	NTSC (3.58MHz)/NTSC (4.43MHz)/PAL/PAL-60/SECAM	
Plug and play	VESA DDC2B	
Power management	VESA DPMS	
Input terminals	PC/AV	HDMI x 3
	PC	Mini D-sub 15 pin, 3 rows x 2 DisplayPort x 1
	Audio	3.5 mm mini stereo jack x 2
	Serial (RS-232C)	3.5 mm mini jack x 1
Output terminals	Video/Audio	DisplayPort x 1
	Audio	3.5 mm mini stereo jack x 1
LAN terminal	10 BASE-T/100 BASE-TX	
Speaker output (internal/external)	10 W + 10 W/10 W + 10 W 6 Ω	
Touch Panel	Detection method	Capacitive type
	PC connector	USB (2.0 compliant) (Type B) x 2
Touch pen	Wireless communication method (2.4 GHz, IEEE 802.15.4 compliant, DS-SS method)	
	Touch pen adapter port	USB (2.0 compliant) (Type A)
Power requirement	AC 100 V - 240 V, 3.2 A, 50/60 Hz	
Operating temperature ^{*2*}	41°F to 95°F (5°C to 35°C)	
Operating humidity ^{*3}	20% to 80% (no condensation)	
Power consumption (Maximum / input signal waiting mode ^{*4} / standby mode ^{*5})	280 W / 6.0 W / 3.5 W	
Dimensions (excluding protrusions)	inch (mm)	Approx. 72-13/16 (W) x 3-3/4 (D) x 42-3/16 (H) (1850 x 96 x 1072)
Weight	lbs. (kg)	Approx. 169.8 (77)

*1 D-sub input terminal only.

*2 Temperature condition may change when using the monitor together with the optional equipments recommended by SHARP.
In such cases, please check the temperature condition specified by the optional equipments.

*3 In addition, check the requirements of the computer and other devices to be connected, and make sure that all requirements are satisfied.

*4 When CONNECT AUTO INPUT SELECT and NO SIGNAL AUTO INPUT SEL. are set to OFF.

*5 When STANDBY MODE is set to STANDARD. When STANDBY MODE is set to LOW POWER: 0.5 W

As a part of our policy of continuous improvement, SHARP reserves the right to make design and specification changes for product improvement without prior notice. The performance specification figures indicated are nominal values of production units. There may be some deviations from these values in individual units.

■ Dimensional Drawings

Note that the values shown are approximate values.

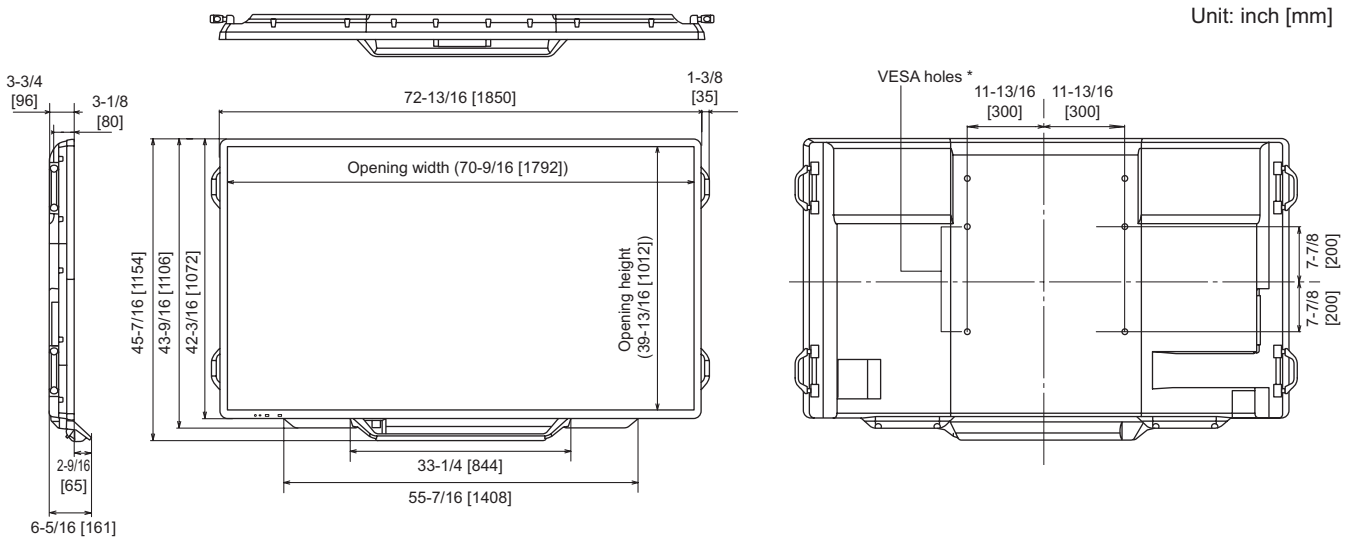

When mounting the monitor, be sure to use a wall-mount bracket that complies with the VESA-compatible mounting method. SHARP recommends using M6 screws and tighten the screws.

Note that screw hole depth of the monitor is 3/8 inch (10 mm). Loose mounting may cause the product to fall, resulting in serious personal injuries as well as damage to the product. The screw and hole should come together with over 5/16 inch (8 mm) length of thread. Use a bracket which has been approved for UL1678 standard, and which can endure at least 4 times or more the weight of the monitor.

Specifications

■Power management

This monitor conforms to VESA DPMS. Both your video card and computer must support the same standard in order for the monitor's power management function to work.

DPMS: Display Power Management Signaling

DPMS	Screen	Power consumption	Hsync	Vsync
ON STATE	Display	280 W	Yes	Yes
STANDBY	No display	6.0 W*	No	Yes
SUSPEND			Yes	No
OFF STATE			No	No

* When CONNECT AUTO INPUT SELECT and NO SIGNAL AUTO INPUT SEL. are set to OFF.

■DDC (plug and play)

The monitor supports the VESA DDC (Display Data Channel) standard.

DDC is a signal standard for plug and play between monitors and computers. Information about resolution and other parameters is exchanged between the two. This function can be used if the computer supports DDC and it has been configured to detect plug-and-play monitors.

There are several types of DDC, depending on the communication method used. This monitor supports DDC2B.

■Compatible signal timing (PC)

Screen resolution		Hsync	Vsync	Dot frequency	Digital		Analog (D-SUB)
					DisplayPort	HDMI	
VESA	640 × 480	31.5kHz	60Hz	25.175MHz	Yes	Yes	Yes
		37.9kHz	72Hz	31.5MHz	Yes	Yes	Yes
		37.5kHz	75Hz	31.5MHz	Yes	Yes	Yes
	800 × 600	35.1kHz	56Hz	36.0MHz	-	-	Yes
		37.9kHz	60Hz	40.0MHz	Yes	Yes	Yes
		48.1kHz	72Hz	50.0MHz	Yes	Yes	Yes
		46.9kHz	75Hz	49.5MHz	Yes	Yes	Yes
	848 × 480	31.0kHz	60Hz	33.75MHz	-	-	Yes
	1024 × 768	48.4kHz	60Hz	65.0MHz	Yes	Yes	Yes
		56.5kHz	70Hz	75.0MHz	Yes	Yes	Yes
		60.0kHz	75Hz	78.75MHz	Yes	Yes	Yes
	1152 × 864	67.5kHz	75Hz	108.0MHz	Yes	Yes	Yes
	1280 × 768	47.8kHz	60Hz	79.5MHz	Yes	-	Yes
		60.3kHz	75Hz	102.25MHz	Yes	-	Yes
	1280 × 800	49.7kHz	60Hz	83.5MHz	Yes	Yes	Yes
	1280 × 960	60.0kHz	60Hz	108.0MHz	Yes	Yes	Yes
	1280 × 1024	64.0kHz	60Hz	108.0MHz	Yes	Yes	Yes
		80.0kHz	75Hz	135.0MHz	Yes	Yes	Yes
	1360 × 768	47.7kHz	60Hz	85.5MHz	Yes	Yes	Yes
	1400 × 1050	65.3kHz	60Hz	121.75MHz	Yes	Yes	Yes
1440 × 900	55.9kHz	60Hz	106.5MHz	Yes	Yes	Yes	
1600 × 1200*	75.0kHz	60Hz	162.0MHz	Yes	Yes	Yes	
1680 × 1050	65.3kHz	60Hz	146.25MHz	Yes	Yes	Yes	
1920 × 1200*	74.0kHz	60Hz	154.0MHz	Yes	Yes	Yes	
Wide	1280 × 720	44.7kHz	60Hz	74.4MHz	Yes	Yes	Yes
	1920 × 1080	67.5kHz	60Hz	148.5MHz	Yes	Yes	Yes
US TEXT	720 × 400	31.5kHz	70Hz	28.3MHz	Yes	Yes	Yes
Sun	1024 × 768	48.3kHz	60Hz	64.13MHz	-	-	Yes
		53.6kHz	66Hz	70.4MHz	-	-	Yes
		56.6kHz	70Hz	74.25MHz	-	-	Yes
	1152 × 900	61.8kHz	66Hz	94.88MHz	-	-	Yes
		71.8kHz	76.2Hz	108.23MHz	-	-	Yes
	1280 × 1024	71.7kHz	67.2Hz	117.01MHz	-	-	Yes
		81.1kHz	76Hz	134.99MHz	-	-	Yes
	1600 × 1000	68.6kHz	66Hz	135.76MHz	-	-	Yes

* Displays a reduced image, except in Dot by Dot. In Dot by Dot, the image will be cut down to panel size then displayed.

- Depending on the connected PC, images may not be displayed properly even if the compatible signal described above is input.
- The frequency values for the Sun are reference values.

■Compatible signal timing (AV)

Screen resolution	Frequency	HDMI	Component
1920 × 1080p	24Hz	Yes	-
	50Hz	Yes	Yes
	59.94Hz	Yes	Yes
	60Hz	Yes	Yes
1920 × 1080i	50Hz	Yes	Yes
	59.94Hz	Yes	Yes
	60Hz	Yes	Yes
1280 × 720p	50Hz	Yes	Yes
	59.94Hz	Yes	Yes
	60Hz	Yes	Yes
720 × 576p	50Hz	Yes	Yes
720 × 480p	59.94Hz	Yes	Yes
	60Hz	Yes	Yes
640 × 480p(VGA)	59.94Hz	Yes	-
	60Hz	Yes	-
720(1440) × 576i	50Hz	Yes	Yes
720(1440) × 480i	59.94Hz	Yes	Yes
	60Hz	Yes	Yes

Specifications

■D-sub input terminal pins

(Mini D-sub 15 pin)

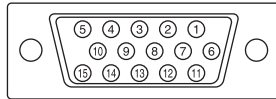

No.	Function	No.	Function
1	Red video signal input	9	+5V
2	Green video signal input	10	GND
3	Blue video signal input	11	N.C.
4	N.C.	12	DDC data
5	GND	13	Hsync signal input
6	GND for red video signal	14	Vsync signal input
7	GND for green video signal	15	DDC clock
8	GND for blue video signal		

■DisplayPort input terminal pins

(DisplayPort 20 pin)

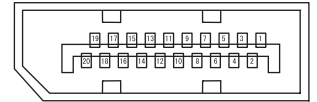

No.	Function	No.	Function
1	MainLane 3-	11	Gnd
2	Gnd	12	MainLane 0+
3	MainLane 3+	13	Gnd
4	MainLane 2-	14	Gnd
5	Gnd	15	Aux +
6	MainLane 2+	16	Gnd
7	MainLane 1-	17	Aux -
8	Gnd	18	Hot-plug detection
9	MainLane 1+	19	Gnd
10	MainLane 0-	20	3.3V

■HDMI input terminal pins

(HDMI™ Connector)



No.	Function	No.	Function
1	TMDS data 2+	11	TMDS clock shield
2	TMDS data 2 shield	12	TMDS clock-
3	TMDS data 2-	13	CEC
4	TMDS data 1+	14	N.C.
5	TMDS data 1 shield	15	SCL
6	TMDS data 1-	16	SDA
7	TMDS data 0+	17	DDC/CEC GND
8	TMDS data 0 shield	18	+5V
9	TMDS data 0-	19	Hot-plug detection
10	TMDS clock+		

■DisplayPort output terminal pins

(DisplayPort 20 pin)

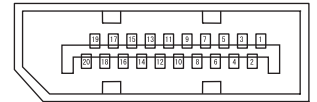

No.	Function	No.	Function
1	MainLane 0+	11	Gnd
2	Gnd	12	MainLane 3-
3	MainLane 0-	13	Gnd
4	MainLane 1+	14	Gnd
5	Gnd	15	Aux +
6	MainLane 1-	16	Gnd
7	MainLane 2+	17	Aux -
8	Gnd	18	Hot-plug detection
9	MainLane 2-	19	Gnd
10	MainLane 3+	20	3.3V

Mounting Precautions (For SHARP dealers and service engineers)

- When installing, removing or moving the monitor, ensure that this is carried out by at least 4 people.
- Be sure to use a wall-mount bracket designed or designated for mounting the monitor.
- This monitor is designed to be installed on a concrete wall or pillar. Reinforced work might be necessary for some materials such as plaster / thin plastic board / wood before starting installation.
This monitor and bracket must be installed on a wall which can endure at least 4 times or more the weight of the monitor. Install by the most suitable method for the material and the structure.
- To attach a VESA-compliant mounting bracket, use M6 screws that are 5/16 inch (8 mm) to 3/8 inch (10 mm) longer than the thickness of the mounting bracket.

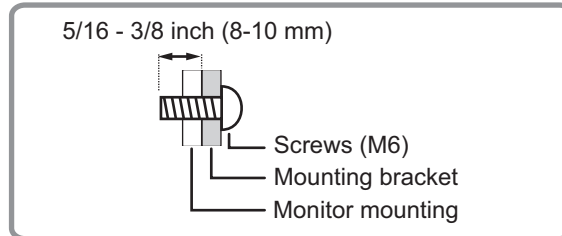

- Do not use an impact driver.
- After mounting, please carefully ensure the monitor is secure, and not able to come loose from the wall or mount.
- Do not use any screw holes other than VESA holes for installation.
- When moving the monitor, be sure to hold it with the handles and the unit bottom. Do not grasp the screen, tray, speaker, or speaker cover. This may cause product damage, failure, or injury.
- If you need to temporarily place the monitor on a table or other surface during installation, spread a thick soft cloth on the table to prevent damage to the screen and table.
- Prior to repacking or removal, remove the tray and speaker covers.

■ Attaching the Tray

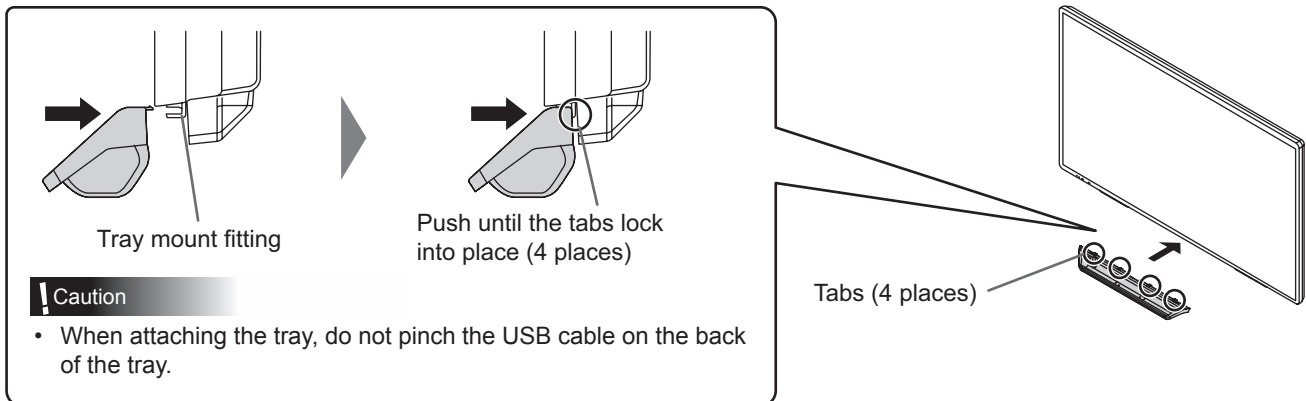

The USB cable on the back of the tray can be fastened with the cable clamp to the rear of the monitor.

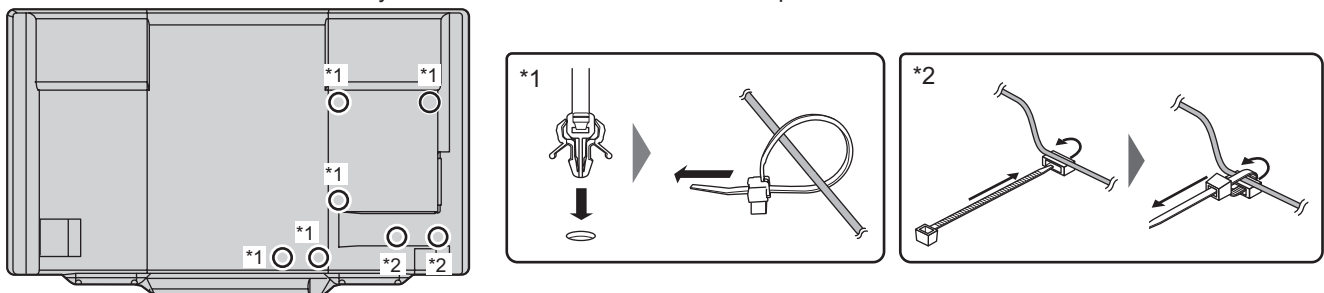

Mounting Precautions (For SHARP dealers and service engineers)

■Removing the Tray

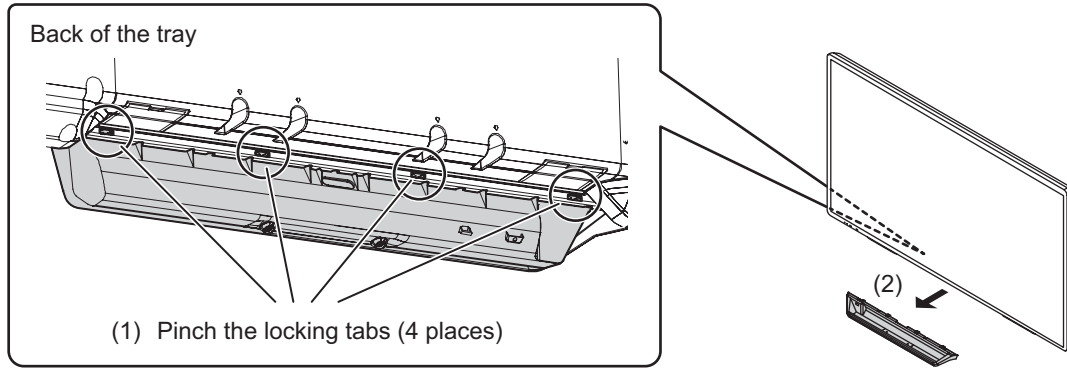

■Attaching the speaker covers

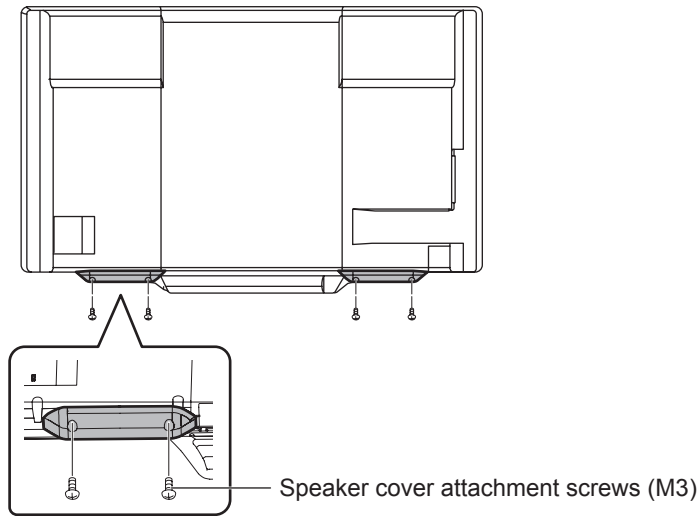

If you will use the monitor in a portrait orientation, the speaker cover is not used.

■Removing the tray mount fitting

If you will use the monitor in a portrait orientation or will otherwise not use the tray, remove the tray mount fitting.

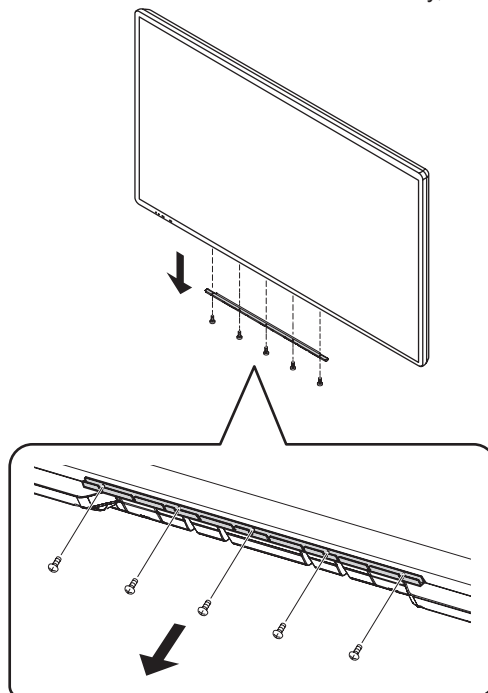

SHARP[®]
SHARP CORPORATION