

**SHARP**

# **OPERATION MANUAL**

**LCD MONITOR**

**MODEL:**

**PN-HE751**

**PN-HE651**

**PN-HC861**

**PN-HC751**

**PN-HC651**

# Table of Contents

---

IMPORTANT INFORMATION.....	2	SAFETY PRECAUTIONS.....	3
DEAR SHARP CUSTOMER .....	3	TIPS AND SAFETY INSTRUCTIONS.....	5

## Chapter 1 Installation

---

Setup Overview .....	7	Orientation .....	13
Mounting (for Customer) .....	10	Ventilation Requirements.....	14
Mounting Precautions (For SHARP dealers and service engineers) .....	11	Mounting on Walls or Ceilings.....	15
Mounting Location.....	12		

## Chapter 2 Parts Names and Functions

---

Control Panel.....	18	Wireless Remote Control.....	20
Terminal Panel.....	19		

## Chapter 3 Connections

---

Wiring Diagram.....	22	Internal Video Sources .....	27
Connecting to a Personal Computer .....	23	Media Player.....	27
Connecting to a Media Device with HDMI .....	24	Connecting a USB Device.....	28
HDMI-CEC Command .....	26		

## Chapter 4 Basic Operation

---

Power On and Off Modes.....	30	Operating Range for the Remote Control.....	32
Off mode.....	30	Showing the Information OSD .....	33
Power indicator status .....	30	Switching Between Picture Modes.....	33
Energy Mode .....	30	Setting the Aspect Ratio.....	34
When [RS-232C] is selected for control .....	30	OSD (On-Screen Display) Controls.....	35
When [LAN] is selected for control .....	31	Using the Media Player Menu .....	36

## Chapter 5 Advanced Operation

---

Creating a Power Schedule.....	40	Setting Security and Locking the Monitor Controls .....	42
Using Picture Modes .....	41	Locking the Button Controls .....	43

## Chapter 6 External Control

---

Controlling the Monitor via RS-232C .....	46	HTTP Browser.....	49
Controlling the Monitor via LAN.....	47	Commands .....	51

## Chapter 7 Troubleshooting

---

When a problem occurs with the monitor.....	54	Others (remote control, speakers) .....	56
Nothing is displayed.....	54	Others (when connected via RS-232C or LAN) .....	57
The image is not displayed correctly .....	55	When using a media player.....	57
An instruction or caution screen is displayed .....	56	When using a video device .....	57
Others (when connected to a computer) .....	56		

## Chapter 8 Specifications

---

Compatible Signal List .....	59	PN-HC861 .....	63
PN-HE751.....	61	PN-HC751 .....	64
PN-HE651.....	62	PN-HC651 .....	65

## Appendix A Trademark and Software License

---

## Appendix B OSD Controls List

---

Picture Settings .....	68	Control Settings .....	73
Audio Settings .....	70	Media Player.....	74
Setup .....	71	Schedule .....	75

## Appendix C Others

---

RS-232C command table .....	77	Intellectual Property Rights and Other Matters .....	79
-----------------------------	----	--	----

**IMPORTANT:**

To aid reporting in case of loss or theft, please record the product's model and serial numbers in the space provided. The numbers are located in the rear of the product.





Model No.:

Serial No.:

U.S.A. ONLY

# IMPORTANT INFORMATION

**WARNING:** TO REDUCE THE RISK OF FIRE OR ELECTRIC SHOCK, DO NOT EXPOSE THIS PRODUCT TO RAIN OR MOISTURE.

 <p><b>CAUTION</b> RISK OF ELECTRIC SHOCK DO NOT OPEN</p> 		<p>The lightning flash with arrowhead symbol, within a triangle, is intended to alert the user to the presence of uninsulated “dangerous voltage” within the product’s enclosure that may be of sufficient magnitude to constitute a risk of electric shock to persons.</p>
<p><b>CAUTION:</b> TO REDUCE THE RISK OF ELECTRIC SHOCK, DO NOT REMOVE COVER. NO USER-SERVICEABLE PARTS INSIDE. REFER SERVICING TO QUALIFIED SERVICE PERSONNEL.</p>		<p>The exclamation point within a triangle is intended to alert the user to the presence of important operating and maintenance (servicing) instructions in the literature accompanying the product.</p>

**WARNING:**  
FCC Regulations state that any unauthorized changes or modifications to this equipment not expressly approved by the manufacturer could void the user’s authority to operate this equipment.

**NOTE:**  
This equipment has been tested and found to comply with the limits for a Class A digital device, pursuant to Part 15 of the FCC Rules. These limits are designed to provide reasonable protection against harmful interference when the equipment is operated in a commercial environment. This equipment generates, uses, and can radiate radio frequency energy and, if not installed and used in accordance with the instruction manual, may cause harmful interference to radio communications. Operation of this equipment in a residential area is likely to cause harmful interference in which case the user will be required to correct the interference at his own expense.

**U.S.A. ONLY**

To maintain compliance with EMC regulations, use shielded cables to connect to the following terminals: HDMI input terminal, D-sub input terminal and RS-232C input terminal.

# DEAR SHARP CUSTOMER

---

Thank you for your purchase of a SHARP LCD product. To ensure safety and many years of trouble-free operation of your product, please read the Safety Precautions carefully before using this product.

## SAFETY PRECAUTIONS

---

Electricity is used to perform many useful functions, but it can also cause personal injuries and property damage if improperly handled. This product has been engineered and manufactured with the highest priority on safety. However, improper use can result in electric shock and/or fire. In order to prevent potential danger, please observe the following instructions when installing, operating and cleaning the product. To ensure your safety and prolong the service life of your LCD product, please read the following precautions carefully before using the product.

1. Read instructions — All operating instructions must be read and understood before the product is operated.
2. Keep this manual in a safe place — These safety and operating instructions must be kept in a safe place for future reference.
3. Observe warnings — All warnings on the product and in the instructions must be observed closely.
4. Follow instructions — All operating instructions must be followed.
5. Cleaning — Unplug the power cord from the power outlet before cleaning the product. Use a dry cloth to clean the product. Do not use liquid cleaners or aerosol cleaners. Do not use dirty cloths. Doing so may damage the product.
6. Attachments — Do not use attachments not recommended by the manufacturer. Use of inadequate attachments can result in accidents.
7. Water and moisture — Do not use the product near water. Do not install the product in a place where water may splash onto it. Be careful of equipment which drains water such as an air-conditioner.
8. Ventilation — The vents and other openings in the cabinet are designed for ventilation. Do not cover or block these vents and openings since insufficient ventilation can cause overheating and/or shorten the life of the product. Do not place the product on a sofa, rug or other similar surface, since they can block ventilation openings. Do not place the product in an enclosed place such as a bookcase or rack, unless proper ventilation is provided or the manufacturer's instructions are followed.
9. Power cord protection — The power cords must be routed properly to prevent people from stepping on them or objects from resting on them.
10. The LCD panel used in this product is made of glass. Therefore, it can break when the product is dropped or applied with impact. Be careful not to be injured by broken glass pieces in case the LCD panel breaks.
11. Overloading — Do not overload power outlets or extension cords. Overloading can cause fire or electric shock.
12. Entering of objects and liquids — Never insert an object into the product through vents or openings. High voltage flows in the product, and inserting an object can cause electric shock and/or short internal parts. For the same reason, do not spill water or liquid on the product.
13. Servicing — Do not attempt to service the product yourself. Removing covers can expose you to high voltage and other dangerous conditions. Request a qualified service person to perform servicing.
14. Repair — If any of the following conditions occurs, unplug the power cord from the power outlet, and request a qualified service person to perform repairs.
  - a. When the power cord or plug is damaged.
  - b. When a liquid was spilled on the product or when objects have fallen into the product.
  - c. When the product has been exposed to rain or water.
  - d. When the product does not operate properly as described in the operating instructions. Do not touch the controls other than those described in the operating instructions. Improper adjustment of controls not described in the instructions can cause damage, which often requires extensive adjustment work by a qualified technician.
  - e. When the product has been dropped or damaged.
  - f. When the product displays an abnormal condition. Any noticeable abnormality in the product indicates that the product needs servicing.
15. Replacement parts — In case the product needs replacement parts, make sure that the service person uses replacement parts specified by the manufacturer, or those with the same characteristics and performance as the original parts. Use of unauthorized parts can result in fire, electric shock and/or other danger.
16. Safety checks — Upon completion of service or repair work, request the service technician to perform safety checks to ensure that the product is in proper operating condition.
17. Wall mounting — When mounting the product on a wall, be sure to install the product according to the method recommended by the manufacturer.
18. Heat sources — Keep the product away from heat sources such as radiators, heaters, stoves and other heat-generating products (including amplifiers).

# SAFETY PRECAUTIONS (Continued)

19. Batteries — Incorrect use of batteries may cause the batteries to burst or ignite. A leaky battery may corrode the equipment, dirty your hands or spoil your clothing. In order to avoid these problems, make sure to observe the precautions below:
  - Use the specified batteries only.
  - Install the batteries with due attention to the plus (+) and minus (-) sides of the batteries according to the instructions in the compartment.
  - Do not mix old and new batteries.
  - Do not mix batteries of different types. Voltage specifications of batteries of the same shape may vary.
  - Replace an exhausted battery with a new one promptly.
  - If you will not use the remote control for a long time, remove the batteries.
  - If leaked battery fluid gets on your skin or clothing, rinse immediately and thoroughly. If it gets into your eye, bathe your eye well rather than rubbing and seek medical treatment immediately. Leaked battery fluid that gets into your eye or your clothing may cause a skin irritation or damage your eye.
20. Usage of the monitor must not be accompanied by fatal risks or dangers that, could lead directly to death, personal injury, severe physical damage or other loss, including nuclear reaction control in nuclear facility, medical life support system, and missile launch control in a weapon system.
21. Do not stay in contact with the parts of the product that become hot for long periods of time. Doing so may result in low-temperature burns.
22. Do not modify this product.

## **WARNING:**

This is a Class A product. In a domestic environment this product may cause radio interference in which case the user may be required to take adequate measures.

An apparatus with CLASS I construction shall be connected to a MAIN socket outlet with a protective earthing connection.

## **STABILITY HAZARD**

If a monitor is not positioned in a sufficiently stable location, it can be potentially hazardous due to falling. Many injuries, particularly to children, can be avoided by taking simple precautions such as:

- Using fixing devices like wall mount brackets recommended by the manufacturer.
- Only using furniture that can safely support the monitor.
- Ensuring the monitor is not overhanging the edge of the supporting furniture.
- Not placing the monitor on tall furniture (for example, cupboards or bookcases) without anchoring both the furniture and the monitor to a suitable support.
- Not standing the monitors on cloth or other materials placed between the monitor and supporting furniture.
- Educating children about the dangers of climbing on furniture to reach the monitor or its controls.
- This equipment is not suitable for use in locations where children are likely to be present unsupervised.

## **Especially for child safety**

- Don't allow children to climb on or play with the monitor.
- Don't place the monitor on furniture that can easily be used as steps, such as a chest of drawers.
- Remember that children can become excited while watching a program, especially on a "larger than life" monitor. Care should be taken to place or install the monitor where it cannot be pushed, pulled over, or knocked down.
- Care should be taken to route all cords and cables connected to the monitor so that they cannot be pulled or grabbed by curious children.

# TIPS AND SAFETY INSTRUCTIONS

---

- The TFT color LCD panel used in this monitor is made with the application of high precision technology. However, there may be minute points on the screen where pixels never light or are permanently lit. Also, if the screen is viewed from an acute angle there may be uneven colors or brightness. Please note that these are not malfunctions but common phenomena of LCDs and will not affect the performance of the monitor.
- Do not display a still picture for a long period, as this could cause a residual image.
- Never rub or tap the monitor with hard objects.
- Please understand that SHARP CORPORATION bears no responsibility for errors made during use by the customer or a third party, nor for any other malfunctions or damage to this product arising during use, except where indemnity liability is recognized under law.
- This monitor and its accessories may be upgraded without advance notice.
- Do not use the monitor where there is a lot of dust, where humidity is high, or where the monitor may come into contact with oil or steam. Do not use in an environment where there are corrosive gases (sulfur dioxide, hydrogen sulfide, nitrogen dioxide, chlorine, ammonia, ozone, etc.). As this could lead to fire.
- Ensure that the monitor does not come into contact with water or other fluids. Ensure that no objects such as paper clips or pins enter the monitor as this could lead to fire or electric shock.
- Do not place the monitor on top of unstable objects or in unsafe places. Do not allow the monitor to receive strong shocks or to strongly vibrate. Causing the monitor to fall or topple over may damage it.
- Do not use the monitor near heating equipment or in places where there is likelihood of high temperature, as this may lead to generation of excessive heat and outbreak of fire.
- Do not use the monitor in places where it may be exposed to direct sunlight. Risk of cabinet deformation and failure if the monitor is used in direct sunlight.
- If the monitor is installed in a location exposed to sunlight such as next to a window, measures to reduce ultraviolet and infrared radiation and temperature measures are required. For details, consult your dealer.
- Please be sure to constantly remove dust and garbage that has attached to the ventilation opening. If dust collects in the ventilation opening or the inside of the monitor, it may lead to excessive heat, outbreak of fire, or malfunction. Please request a cleaning of the inside of the monitor from an authorized SHARP servicing dealer or service center.
- Images cannot be rotated on this monitor. When using in portrait orientation, you will need to prepare appropriately orientated content in advance.
- The power outlet shall be installed near the equipment and shall be easily accessible.

## The Power Cord

- Use only the power cord supplied with the monitor.
- Do not damage the power cord nor place heavy objects on it, stretch it or over bend it. Also, do not add extension cords. Damage to the cord may result in fire or electric shock.
- Do not use the power cord with a power tap. Adding an extension cord may lead to fire as a result of overheating.
- Do not remove or insert the power plug with wet hands. Doing so could result in electric shock.
- Unplug the power cord if it is not used for a long time.
- Do not attempt to repair the power cord if it is broken or malfunctioning. Refer the servicing to the service representative.

## Manual Scope

- Language of OSD menu used in this manual is English by way of example.
- Illustrations in this manual may not exactly represent the actual product or display.
- This manual assumes use in landscape orientation, except where specifically noted.

## LED Backlight

- The LED backlight in this product has a limited lifetime.
  - \* If the screen gets dark or does not turn on, it may be necessary to replace the LED backlight.
  - \* This LED backlight is exclusive to this product and must be replaced by an authorized SHARP servicing dealer or service center. Please contact an authorized SHARP servicing dealer or service center for assistance.

# Chapter 1 Installation

## This Chapter Includes:

- ⇒ "Setup Overview" on page 7
- ⇒ "Mounting (for Customer)" on page 10
- ⇒ "Mounting Precautions (For SHARP dealers and service engineers)" on page 11
- ⇒ "Mounting Location" on page 12
- ⇒ "Orientation" on page 13
- ⇒ "Ventilation Requirements" on page 14
- ⇒ "Mounting on Walls or Ceilings" on page 15

## Contents

If any component should be missing, please contact your dealer.

- Monitor: 1
- Remote control unit: 1
- Remote control unit battery: 2
- Setup manual: 1
- Power cord: 1
- Cable clamp (affixing type): 2
- USB flash drive cover: 1
- Logo sticker: 1
- Blank sticker (blindfold of operation buttons printings for PN-HE651/PN-HC651): 1 (for PN-HE651/PN-HC651 only)

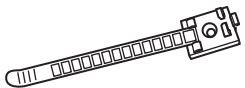

- \* For environmental protection!  
Do not dispose of batteries in household waste. Follow the disposal instructions for your area.

# Setup Overview

---

To ensure safety and many years of trouble-free operation of your product, please read the Safety Precautions carefully before using this product.

- This product is for use indoors.
- A mounting bracket compliant with VESA specifications is required.
- Since the monitor is heavy, consult your dealer before installing, removing or moving the monitor.
- Mounting the monitor on the wall requires special expertise and the work must be performed by an authorized SHARP dealer. You should never attempt to perform any of this work yourself. Our company will bear no responsibility for accidents or injuries caused by improper mounting or mishandling.
- Use the monitor with the surface perpendicular to a level surface. If necessary, the monitor may be tilted up to 20 degrees upward or downward.
- This monitor should be used at an ambient temperature between 32°F (0°C) and 104°F (40°C). Provide enough space around the monitor to prevent heat from accumulating inside. Do not block any ventilation openings. If the temperature inside the monitor rises, this could lead to a malfunction. Do not place the monitor on a device which generates heat.

**NOTE:** To avoid scratching the LCD panel, always place a soft cloth, such as a blanket that is larger than the monitor's screen area, on the table before laying the monitor face down when installing the mounting accessories.

## 1. Install the remote control batteries

1. Place your finger on the part marked with the ▲, and then pull the cover off.
2. See the instructions in the compartment and put in the batteries (R03 or LR03 ("AAA" size) x 2) with their plus (+) and minus (-) sides oriented correctly.
3. Close the cover.

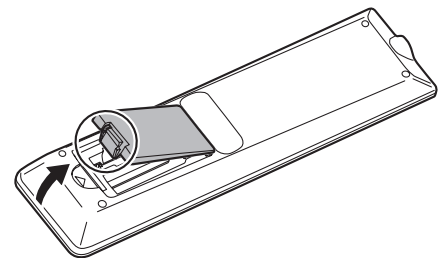

- NOTE:**
- When the batteries become exhausted, replace them with new (commercially available) batteries.
  - The supplied batteries may become exhausted quickly depending on how they are stored.
  - If you will not be using the remote control for a long time, remove the batteries.
  - Use manganese or alkaline batteries only.

## 2. Connect external equipment

- To protect the external equipment, disconnect the power cord of the monitor before making connections.
- Refer to the user's manual of your equipment for further information.
- The supplied cable clamps can be used to clamp the cables connected to the back of the monitor.
- Attach the supplied cable clamps (affixing type) to a flat surface, removing any dust or dirt before attaching.
- Do not attach over a vent.

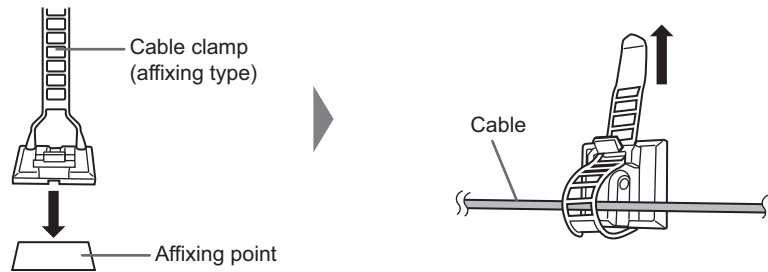

**NOTE:** Do not connect or disconnect the power cable when the monitor's main power or other external equipment's power is turned on.

## 3. Connect the supplied power cord

- NOTE:**
- Make sure that enough power is supplied to the monitor.
  - The main power must be turned on/off with the main power switch. Do not connect/disconnect the power cord or turn the breaker on/off while the main power switch is on.
  - For a complete electrical disconnection, pull out the main plug.
  - Connect the power cord to the monitor before plugging it into the power outlet.
  - The power outlet shall be installed near the equipment and shall be easily accessible.

1. Connect one extremity of the power cord to the power input terminal of the monitor.  
Plug it completely inside.
2. Connect the power plug to an AC power outlet.

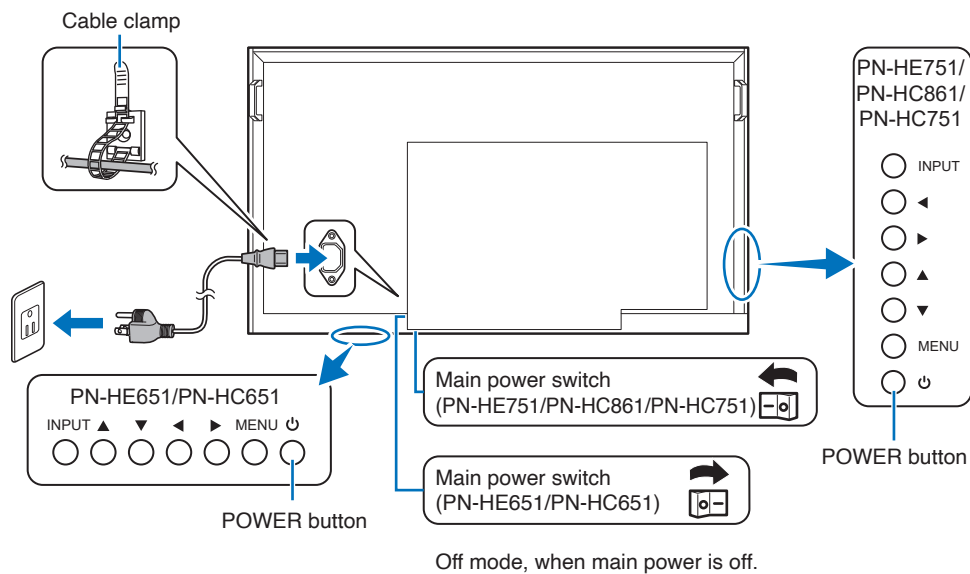

#### 4. Turning on the main power

1. Turn on the main power switch.
2. Press the POWER button to turn the power ON/OFF.  
You can also turn the power ON/OFF by pressing the MONITOR ON button/MONITOR OFF button on the remote control unit.  
When switching the main power switch or the POWER button off and back on, always wait for at least 5 seconds.  
A short interval may result in a malfunction.  
Turn on the monitor first before turning on the computer or playback device.

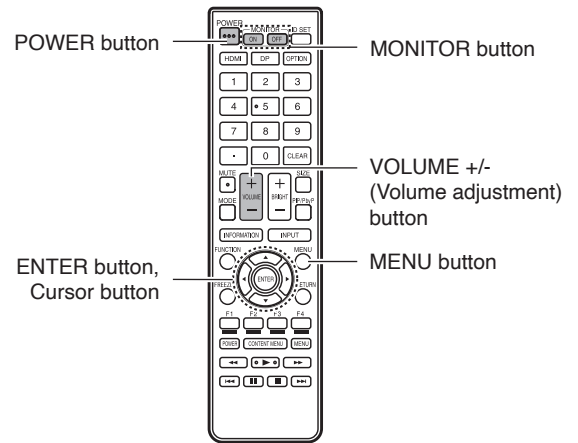

#### Remote control sensor

Be careful not to damage the remote control sensor during installation.

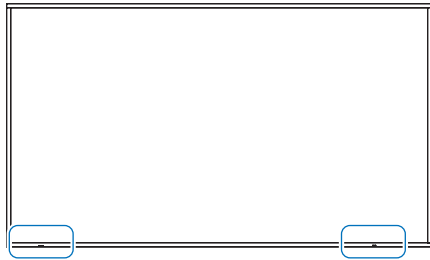

Remote control sensor  
PN-HE751/PN-HC861/PN-HC751

Remote control sensor  
PN-HE651/PN-HC651

#### Time setting

When the monitor is turned on for the first time after being shipped from the factory, the [Setup Wizard] screen will be displayed. Sets the time and language settings with the ▲, ◀ or ▶ button.

The time can be set in the OSD menu under [Schedule] -> [Current Time settings].

The language can be set in the OSD menu under [Setup] -> [OSD Settings] -> [Language].

#### 5. Operate the connected external equipment

Select the input source for the monitor to display the video from the external equipment on the screen.

#### 6. Adjust the sound

Make volume adjustments when required.

#### 7. Adjust the picture settings

When using an HDMI input terminal, select the appropriate setting between [Mode 0], [Mode 1], and [Mode 2] in [EDID] under [HDMI Settings] in the [Setup] OSD menu.

# Mounting (for Customer)

---

Contact your supplier as they may be able to provide a list of qualified installation professionals. Mounting the product on a wall or ceiling and hiring a technician are the customer's responsibility.

## Maintenance

- Periodically check for loose screws, gaps, distortions, or other problems that may occur with the mounting equipment. If a problem is detected, refer to the qualified personnel or the supplier for service.
- Depending on the environment, the mounting location may weaken due to natural degradation. Regularly ask the qualified personnel to inspect the mounting location and carry out maintenance.

Our company assumes no responsibility regarding any damage that may be caused by inadequate installation, misuse, modification of the product, natural disasters, or other such causes.

When asking the qualified personnel for installation, inform them of the precautions mentioned in "Mounting Precautions (For SHARP dealers and service engineers)".

## For long-term use

The backlight used for this monitor has a limited life and its brightness decreases with the usage time.

Also, if the same still image is shown for a long time, "Image Persistence" may occur. "Image Persistence" is a phenomenon in which the image of an LCD remains visible after the image has been changed.

The "Image Persistence" is gradually eliminated by changing the screen, but if the same screen is shown for too long, the "Image Persistence" will not disappear.

To avoid shortening the monitor's lifetime, consider the following:

- Turn off the main power of the monitor when not in use.
- Use the  button on the main unit or the POWER button on the remote control to put the monitor in standby state.
- In the OSD menu, go to [Setup] -> [Power save settings] -> [Energy Mode] -> and select [Home] or [Office]. When there is no input signal, the monitor will automatically switch to power save mode.
- If you cover the panel surface of the main unit with a protective cover made of glass or acrylic, the panel surface will be sealed and the internal temperature will rise.  
Use the computer's power management function or reduce the monitor's brightness to prevent the internal temperature from rising.
- Use [Schedule] in the OSD menu to automatically turn the monitor on or in Standby state as required.

**NOTE:** When using the schedule function, be sure to set [Current Time settings] in the [Schedule] OSD menu.

# Mounting Precautions (For SHARP dealers and service engineers)

When installing, removing or moving the monitor, ensure that this is carried out by at least 4 people. (PN-HE651/PN-HC651 at least 2 people.)

Be sure to use a wall-mount bracket designed or designated for mounting the monitor.

To attach a VESA-compliant mounting bracket, use M8 screws that are 3/8 inch (10 mm) to 1/2 inch (12 mm) longer than the thickness of the mounting bracket.

This monitor and bracket must be installed on a wall which can endure at least 4 times or more the weight of the monitor.

Install by the most suitable method for the material and the structure.

Do not use an impact driver.

When moving the monitor, be sure to hold it around the periphery. Do not grasp the screen. This may cause product damage, failure, or injury.

If you need to temporarily place the monitor on a table or other surface during installation, spread a thick soft cloth on the table to prevent damage to the screen and table.

After mounting, please carefully ensure the monitor is secure, and not able to come loose from the wall or mount.

Do not use any screw holes other than those for mounting brackets, located on the rear of the monitor, for installation.

The product warranty does not cover damage caused by improper installation, re-modeling, or natural disasters.

Failure to comply with these recommendations could result in voiding the warranty.

Pay attention not to obstruct the air vents with the mounting brackets.

## Mounting bracket

- When using commercially-available mounting brackets, make sure that they comply with the VESA Flat Display Mounting Interface Standard (FDMI).
- Prior to mounting, inspect the installation location to ensure that it is strong enough to guaranty safety.
- Pay attention not to obstruct part of the air vents of the monitor with the brackets.
- For detailed information, refer to the instructions included with the mounting equipment.
- There are 4 installation holes on the back. Mount the monitor evenly at the four locations. (See [Mounting on Walls or Ceilings] for installation.)
- Use screws of the sizes mentioned below to fix the brackets to the monitor. Tighten the screws securely.

3/8 - 1/2 inch (10-12 mm)

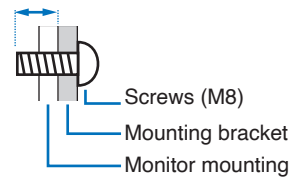

	Screw Size		
	(A)	(B)	
PN-HE751	M8	3/8-1/2 inch (10-12 mm)	+Mounting bracket
PN-HE651			
PN-HC861			
PN-HC751			
PN-HC651			

## Installing a safety wire

When installing the monitor to a wall or a ceiling, use commercially-available wall or ceiling mounting brackets, but also a safety wire.

When attaching the safety wire to the monitor's handle, use the handle locations shown in the figure below.

### Possible locations for the handles used to attach the safety wire

Attach the safety wire to the handles shown in the figure below.

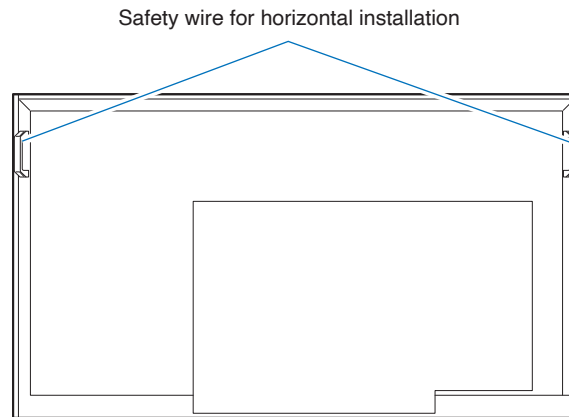

## Mounting Location

---

**NOTE:** Allow for adequate ventilation or provide air conditioning around the monitor, so that heat can properly dissipate away from the monitor and from the mounting equipment.

# Orientation

When using the monitor in a vertical installation, be sure to rotate it counterclockwise so that the right side is on the upper side and the left side is on the bottom.

If installed in the wrong direction, heat may be trapped inside the monitor and the life of the display may be shortened. The monitor cannot be mounted upside down.

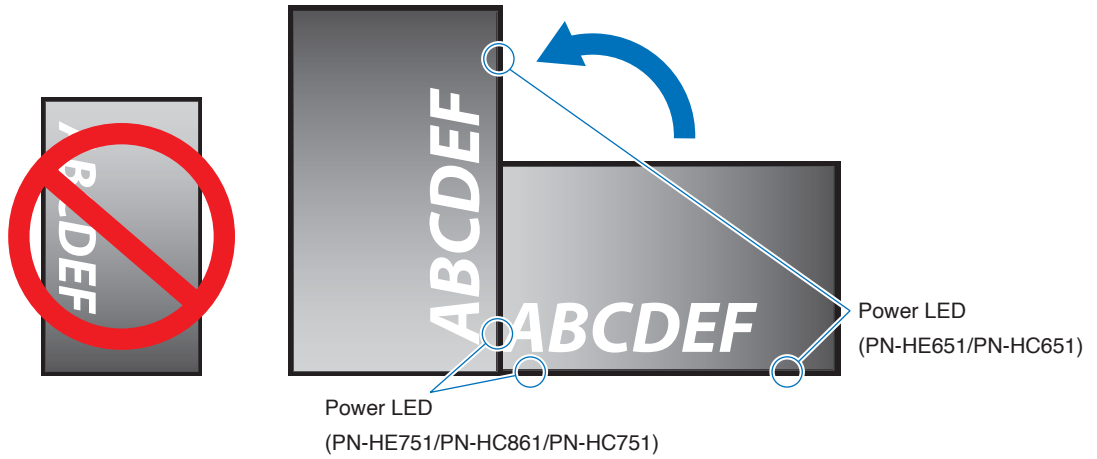

**⚠ WARNING:** Do not install the monitor upside down.



The monitor cannot be used when inclined 20° or more.

**⚠ WARNING:** Installing the monitor at an angle of 20° or more may cause a malfunction.

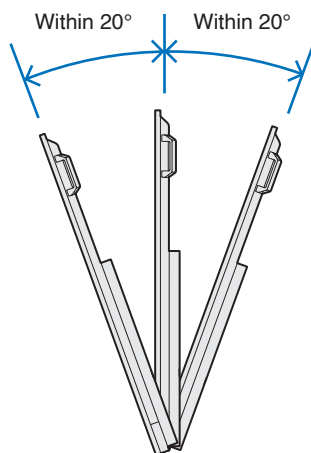

# Ventilation Requirements

When mounting the monitor in an enclosed space or recessed area, leave adequate room between the monitor and the enclosure to allow heat to disperse, as shown below.

### For the monitor in landscape orientation

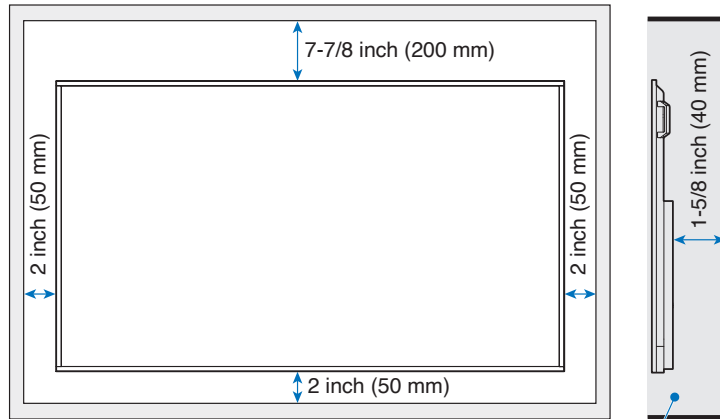

### For the monitor in portrait orientation

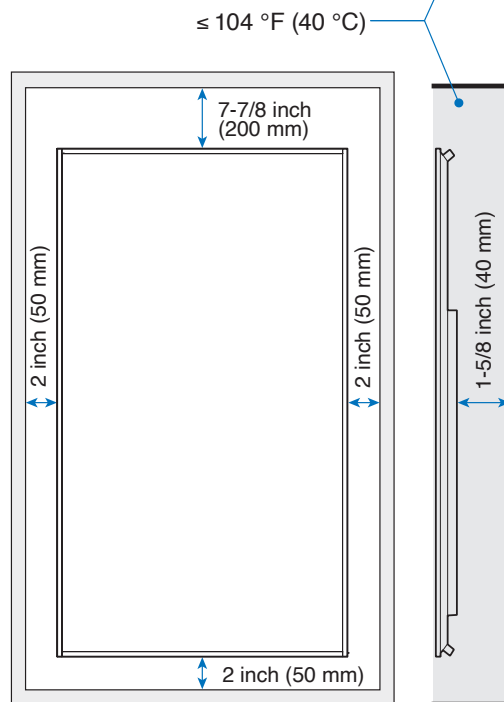

**NOTE:** The maximum environmental operating temperature of the monitor is 104 °F (40 °C). This monitor has internal temperature sensors.

**NOTE:** If the monitor overheats, “Warning!!” appears. If “Warning!!” appears, stop using the monitor, turn off the power and allow it to cool.  
For more information on this function, see “Thermal Management” (page 72).  
If the monitor is used in an enclosed area or if the LCD panel is covered with an acrylic protective sheet, check the temperature around the monitor.

# Mounting on Walls or Ceilings

## Precautions when mounting the monitor on a wall or a ceiling

Be sure to read this section before mounting the monitor on a wall or a ceiling to guarantee safety.

- It may not be possible to mount the monitor on some walls or ceilings depending on their structure or strength. Ask the qualified personnel or the supplier to check the mounting location.

## Installation method

1. Place a soft cloth on the table or another flat location where the monitor will be laid.

**NOTE:** • Make sure that the surface where you will lay the monitor is larger than the monitor screen.

- When installing, do not apply excessive force to any part of the monitor by pushing or leaning on it. This may deform the monitor.

2. Place the monitor on top of the soft cloth.
3. Install the commercially-available mounting brackets.

## PN-HE651/PN-HC651

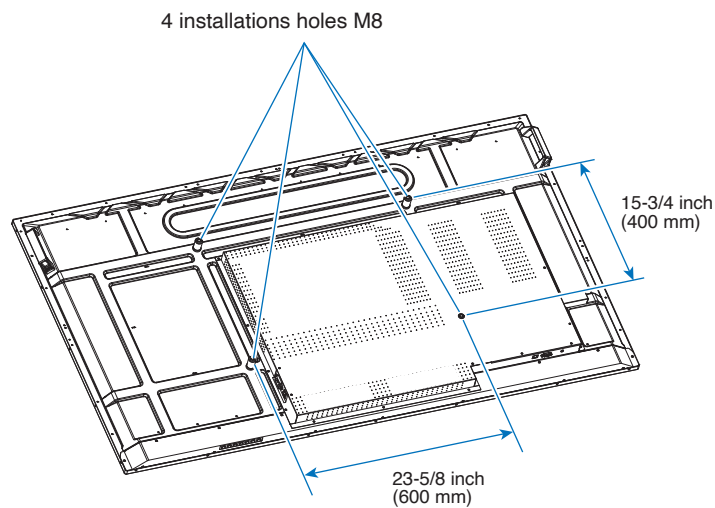

**PN-HE751/PN-HC751**

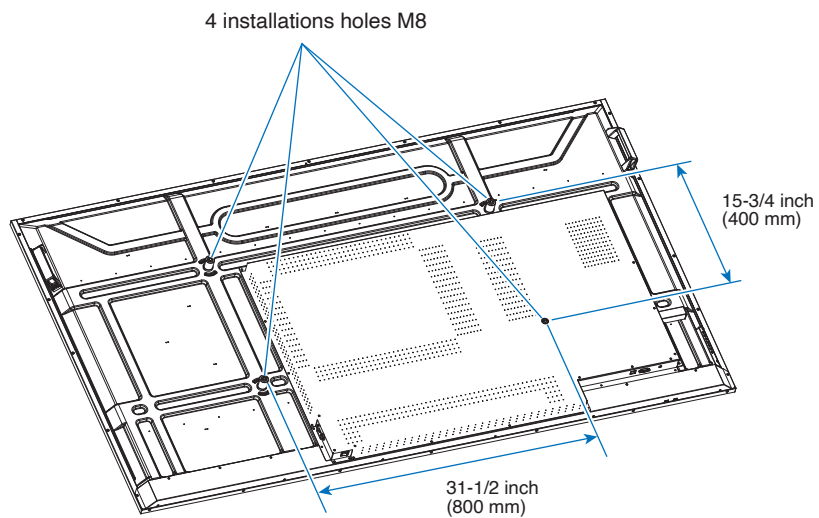

**PN-HC861**

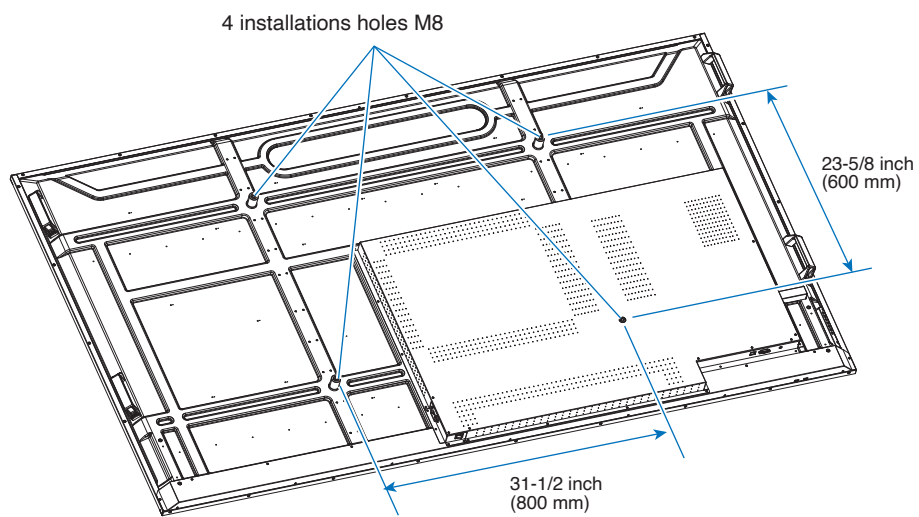

## Chapter 2 Parts Names and Functions

### **This Chapter Includes:**

- ⇒ "Control Panel" on page 18
- ⇒ "Terminal Panel" on page 19
- ⇒ "Wireless Remote Control" on page 20

# Control Panel

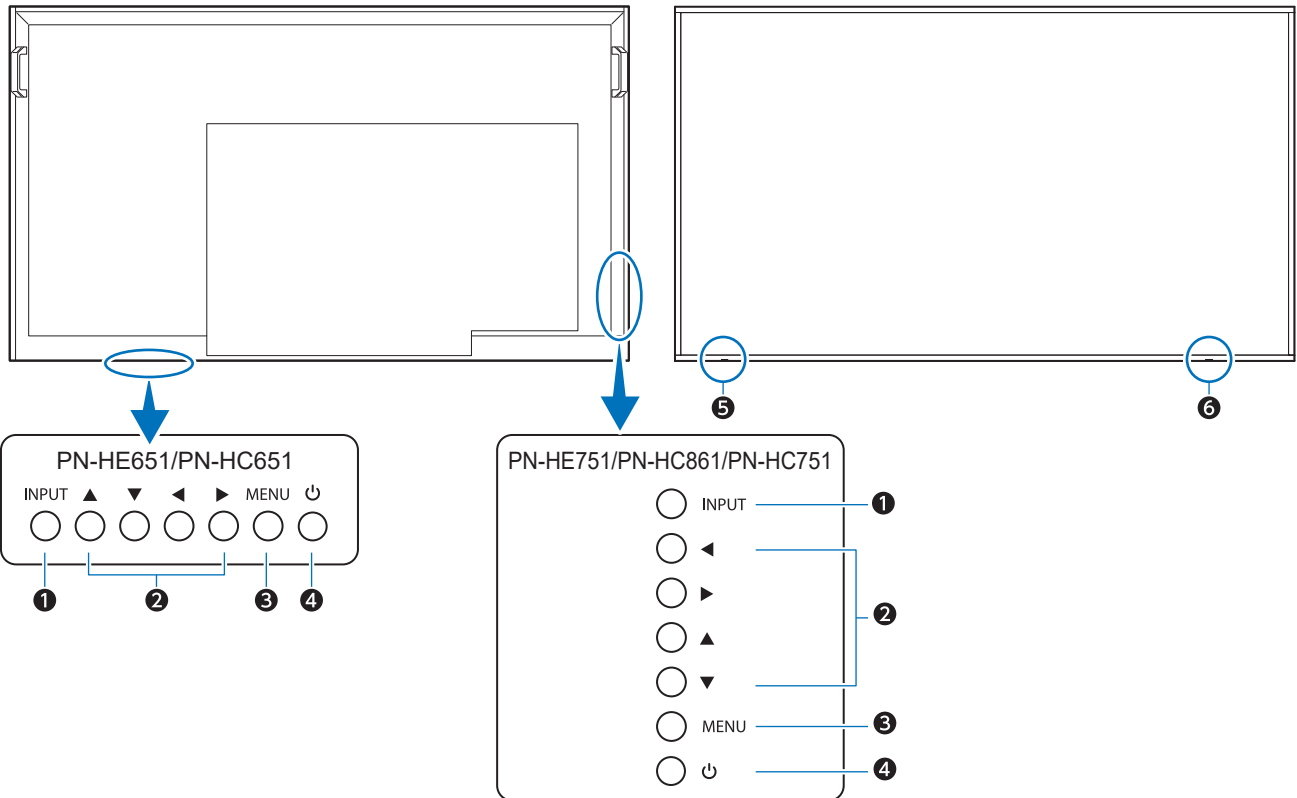

## 1 INPUT Button

Serves as a settings button to make selections when the OSD screen is displayed.  
When the OSD screen is not displayed, the input switching menu is displayed.

Input mode	Video	Audio
HDMI1	HDMI1 input terminal	HDMI1 input terminal* <sup>1</sup>
HDMI2	HDMI2 input terminal	HDMI2 input terminal* <sup>1</sup>
HDMI3	HDMI3 input terminal	HDMI3 input terminal* <sup>1</sup>
VGA	D-sub input terminal	Audio input terminal
Media Player	USB port	USB port

\*1: You can change the [Audio in] in the [Audio Input] settings.

## 2 Arrow Keys

**Left/Right:** Move to the right or left of the OSD control menu.

Moving the left/right keys left and right increases or decreases the adjustment values.

**Up/Down:** Move up and down in the OSD control menu.

Pressing the left/right keys when the OSD menu is closed directly adjusts the volume.

## 3 MENU Button

Opens the OSD menu.  
Returns to the previous OSD menu.

## 4 Power Button (power button)

Switches between power on and off (standby state).

## 5 Power LED/Remote control sensor (PN-HE751/PN-HC861/PN-HC751)

## 6 Power LED/Remote control sensor (PN-HE651/PN-HC651)

This is the signal receiver of the remote control unit.

There is a power LED in the same position.

Normal operation (On mode): Green lit \*<sup>2</sup>

Input signal waiting state: Red flashing

Standby state \*<sup>3</sup> (Off): Red lit

\*<sup>2</sup>: If [Off] is selected in [Setup]-> [Other Settings]-> [LED Indicator] in the OSD menu, the power LED is turned off.

\*<sup>3</sup>: Standby state can be Standby mode or Networked Standby mode. Please refer to page 30-31.

# Terminal Panel

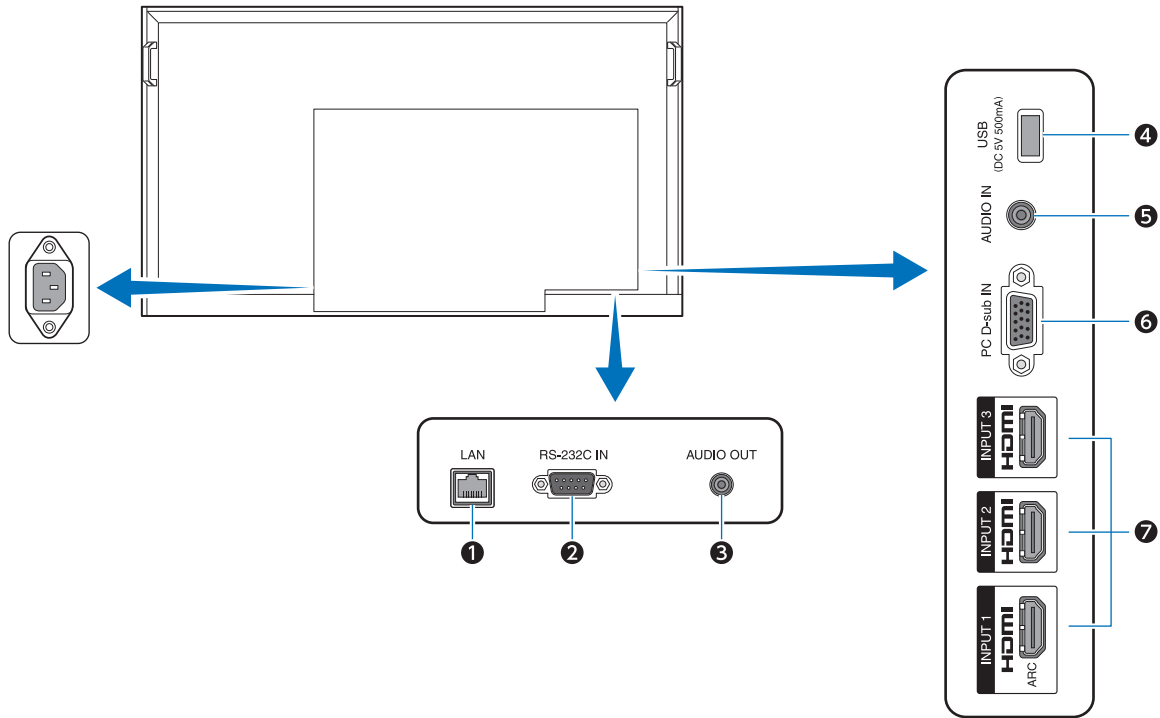

## 1 LAN port (LAN terminal)

Use the HTTP server function and a Web browser on a computer to manage the LAN settings of the monitor.

Receives control commands from the computer.

**NOTE:** When you use a network, your communication data is exposed to the risks of being stolen or illegally accessed. To avoid these risks, you need to use this monitor in a secure network environment.

## 2 RS-232C input terminal

For connection to a computer. Receives control commands from the computer.

## 3 AUDIO OUT terminal (Audio output terminal)

Outputs the selected audio signal.

## 4 USB Type-A port (USB port)

Can be used to display photos (still images) and play video and music files stored in a USB storage device.

Check the shape of the connectors when connecting a USB storage device or USB cable.

## 5 AUDIO IN terminal (Audio input terminal)

For connection to the audio output terminal of a computer or another device.

## 6 VGA input terminal (D-sub input terminal)

For connection to the video output terminal (analog) of a computer.

## 7 HDMI input terminals (HDMI1 (ARC)/HDMI2/HDMI3)

For connection to devices with digital video interface complying with the HDMI standard. HDMI1 terminal also supports ARC (Audio Return Channel) for audio output. Connect an HDMI cable supporting ARC to this terminal.

Connect audio devices supporting ARC to the HDMI1 (ARC) terminal.

**NOTE:** ARC sends the monitor's sound to the audio equipment from the HDMI1 ARC terminal.

# Wireless Remote Control

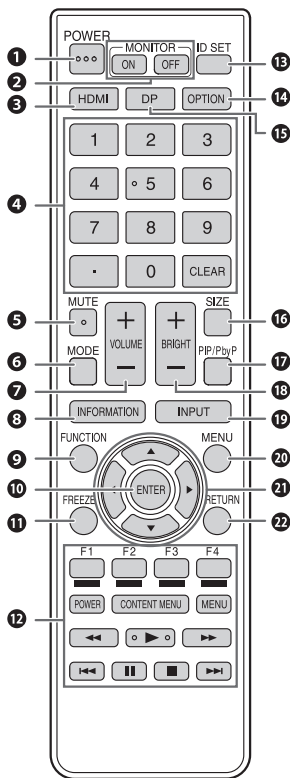

## 1 POWER button

Press the POWER button to turn the power ON/OFF.

## 2 MONITOR buttons

You can also turn the power ON/OFF by pressing the MONITOR ON button/MONITOR OFF button on the remote control unit.

**NOTE:** When the main power switch is off, the monitor cannot be turned on.

## 3 HDMI button

Switch the input mode to HDMI1, HDMI2 or HDMI3.

## 4 Numeric input buttons

When CEC in the HDMI Settings menu is set to On, use these buttons to operate the device connected through the HDMI interface.

## 5 MUTE button

Silences the audio and video.

For settings, see "Mute Settings" (page 72).

## 6 MODE button (picture mode selection)

Each time you press this button, the color mode changes in the following order:

HDR Video -> Dynamic -> Standard -> Conferencing -> HighBright -> Custom -> HDR Video...

## 7 VOLUME button +/- (Volume adjustment)

Press + or - to adjust the volume.

## 8 INFORMATION button

Displays monitor information.

## 9 FUNCTION button

This is not used with this monitor.

## 10 ENTER button

Confirms the setting.

## 11 FREEZE button

Freezes the video shown on the monitor. In some cases a residual image may occur. Do not freeze the video for a long time.

## 12 Buttons for MEDIA PLAYER or operating the HDMI-connected device

- This is used in MEDIA PLAYER.
- When CEC in the HDMI Settings menu is set to On, use these buttons to operate the device connected through the HDMI interface.

## 13 ID SET button

This is not used with this monitor.

## 14 OPTION button

This is not used with this monitor.

## 15 DP button (DisplayPort)

This is not used with this monitor.

## 16 SIZE button (Changing aspect ratio)

Selects the aspect ratio of the image between [Normal], [1:1], [Full], and [Zoom].

## 17 PIP/PbyP button

This is not used with this monitor.

## 18 BRIGHT button +/- (Brightness adjustment)

Press + or - to adjust the brightness.

## 19 INPUT button (Input mode selection)

The menu is displayed. Press the up/down keys to select the input mode, and press the ENTER button to enter.

Input mode	Video	Audio
HDMI1	HDMI1 input terminal	HDMI1 input terminal* <sup>1</sup>
HDMI2	HDMI2 input terminal	HDMI2 input terminal* <sup>1</sup>
HDMI3	HDMI3 input terminal	HDMI3 input terminal* <sup>1</sup>
VGA (RGB)	D-sub input terminal	Audio input terminal
Media Player	USB port	USB port

\*<sup>1</sup> You can change the [Audio in] in the [Audio Input] settings.

## 20 MENU button

Opens the OSD menu.

Returns to the previous OSD menu.

## 21 Cursor buttons

These buttons are used to perform operations such as selecting items, changing adjustment values, and moving the cursor.

## 22 RETURN button

Returns to the previous OSD menu.

# Chapter 3 Connections

## This Chapter Includes:

- ⇒ "Wiring Diagram" on page 22
- ⇒ "Connecting to a Personal Computer" on page 23
- ⇒ "Connecting to a Media Device with HDMI" on page 24
- ⇒ "HDMI-CEC Command" on page 26
- ⇒ "Internal Video Sources" on page 27
- ⇒ "Media Player" on page 27
- ⇒ "Connecting a USB Device" on page 28

## Before making connections:

- Turn off the power of the monitor, the computer and the external equipment before connecting the monitor to the computer.
- Refer to the external equipment's user manuals for available connection types and instructions for each piece of equipment.

- NOTE:**
- When the audio output connector of the connected audio device or computer is a stereo mini jack, use an audio cable without a resistor.
  - Using an audio cable with a built-in resistor may make it impossible to increase the volume or mute the sound.
  - We recommend turning off the monitor's main power before connecting or disconnecting a USB storage device.
  - Do not connect or disconnect cables when the monitor's main power or other external equipment's power is turned on.

# Wiring Diagram

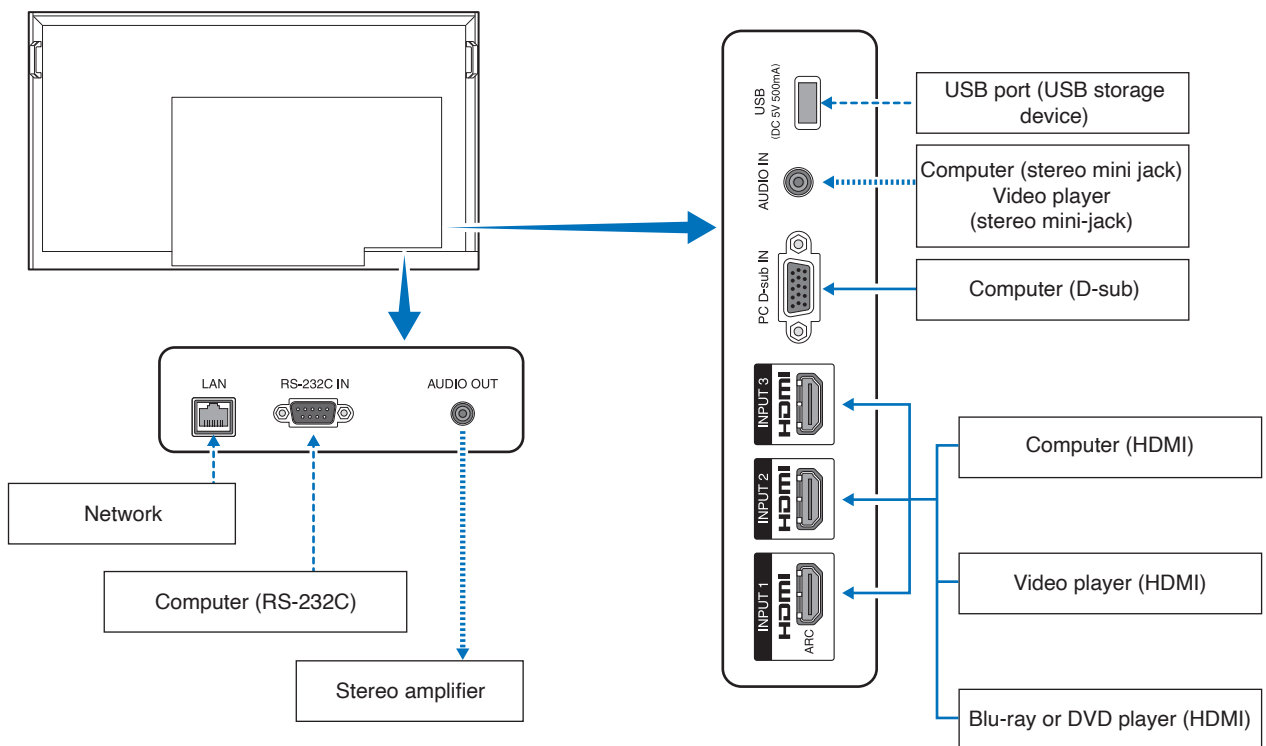

- - - - - : Other signals
- : Video signal
- ..... : Audio signal

# Connecting to a Personal Computer

---

## Connecting to a Computer with HDMI

---

The monitor can be connected to and used with video players and computers equipped with an HDMI output. For more information, refer to the user's manual of the player or the other devices.

- Use an HDMI cable with the HDMI logo.
- It may take a moment for the signal to appear after turning on the device outputting the HDMI signal.
- Depending on the video card or driver used, the image may not be shown correctly.
- When you use a computer with HDMI, go to the OSD menu [Picture] -> [Advanced] and set [Overscan] to [Auto] or [Off].
- If the monitor's main power is turned on after the connected computer has been turned on, the image may not be displayed. In this case, turn off the computer then turn it on again.
- If the source signal is 4K (50 Hz/60 Hz), HDCP 2.2 or HDR, go to the OSD menu [Setup] c [HDMI Settings] -> [EDID] and set [Mode 2]. If the monitor cannot be displayed correctly, set to [Setting 0] or [Setting 1].
- When inputting a 4K signal, use a high-speed or premium high-speed HDMI cable.

# Connecting to a Media Device with HDMI

---

The monitor can be connected using a single HDMI cable to Blu-ray players, streaming media players, or game consoles for the highest picture and audio quality. 4K UHD content is shown when the connected media player also supports 4K content.

Supports HDCP (High-bandwidth Digital Contents Protection) coding, a type of digital rights management that prevents high-definition content, in Blu-ray discs, DVDs and streaming media, from being copied or broadcast illegally.

- NOTE:**
- Supports 1080p, 1080i, 720p@50 Hz/60 Hz, 480p@60 Hz, 576p@50 Hz, 480i@60 Hz, 576i@50 Hz, 3840×2160 (24 Hz/25 Hz/30 Hz [Mode 1] [Mode 2]), 3840×2160 (50 Hz/60 Hz [Mode 2]), 4096×2160 (24 Hz/25 Hz/30 Hz [Mode 1]), 4096×2160 (50 Hz/60 Hz [Mode 2]).
  - Connect the HDMI cable when both the media player and the monitor are powered off.
  - Use an HDMI cable with the HDMI logo.
  - Some HDMI cables and devices may not show the image correctly due to different HDMI specifications.
  - With the implementation of HDCP, there may be cases in which certain content is protected by HDCP and might not be displayed. This is not a malfunction.

## Connecting to Audio Equipment with ARC Function

---

When audio equipment with the ARC function is connected to the HDMI1 (ARC) terminal of the monitor using the ARC-supported HDMI cable, the speakers connected to the audio equipment outputs the monitor's sound.

- The sound output via HDMI1 (ARC) is not adjustable with the OSD menu.
- When the ARC function is activated, the monitor's internal speakers are muted.
- The sound of the video displayed on the screen is output to the audio equipment via the HDMI1 (ARC) terminal. Audio signals not supported by the input terminal used for the video being displayed are not output by the HDMI1 (ARC) terminal. Refer to "Specifications" for the supported signal of each input terminal.

## HDMI-CEC (Consumer Electronics Control)

---

HDMI-CEC provides compatible video devices connected via HDMI with the ability to communicate and allows limited control between the device and the monitor. For example, playing a Blu-ray player can immediately switch input to the Blu-ray player without using the remote control. Not all devices are fully compatible, and, in some cases, the media device manufacturer may only provide compatibility with its own monitors or TVs. See "HDMI-CEC Command" (page 26).

When supported, the monitor's remote control can be used to control the video device.

**NOTE:** The instructions in this section guide you through configuring [CEC] in the monitor's OSD menu.

## Enabling CEC

1. Connect an HDMI-CEC compatible device to the HDMI terminal.  
Press the HDMI button of the remote control.
2. Press the MENU button to open the OSD menu.
3. In the OSD menu, go to [Setup] -> [HDMI Settings] -> [CEC] -> and select [On] in [CEC].
4. In the OSD menu, go to [Setup] -> [HDMI Settings] -> [CEC] -> [Device list] and press the ENTER button of the remote control.  
When the device search is complete, connected devices are shown by their names.  
If no HDMI-CEC compatible device is found, make sure the device is connected, turned on, that it supports CEC, and that CEC is enabled. Depending on the manufacturer, the CEC feature may have a different name. Refer to the device's user manual.
5. Press the RETURN button of the remote control.

# HDMI-CEC Command

Connect an HDMI-CEC compatible device to the HDMI terminal.

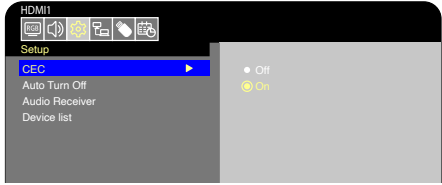
OSD menu	HDMI-CEC command name	Explanation	Setting
CEC (Consumer Electronics Control)	One Touch Play	When an HDMI-CEC compatible device is played, the monitor connected to the device with an HDMI cable also automatically turns on. After the monitor powers on, Input terminal automatically switches. If the monitor is already turned on, the monitor connected to the HDMI-CEC compatible device with an HDMI cable also automatically turns on. After the monitor powers on, Input terminal automatically switches.	 <p>In the OSD menu, go to [Setup] -&gt; [HDMI Settings] -&gt; [CEC] -&gt; and select [On] in [CEC].</p>
	Remote Control Pass Through	The monitor's remote control button operation can function with HDMI-CEC compatible devices connected with an HDMI cable. For example, part of the HDMI-CEC compatible device menu can be operated using the remote control.	
	Power Status	The connected HDMI-CEC compatible devices can obtain the monitor's power status, such as if the monitor is in standby state or on.	
	System Information	This function obtains information from a connected HDMI-CEC compatible device (CEC version, physical address, etc.).	
Auto Turn Off	System Standby	If the monitor is set to standby state using the remote control, the HDMI-CEC compatible device connected with an HDMI cable also goes into standby state at the same time. If the monitor goes into standby state while an HDMI-CEC compatible device is recording, the device remains on. Refer to the user's manual supplied with the HDMI-CEC compatible device for further information.	In the OSD menu, go to [Setup] -> [HDMI Settings] -> [CEC] and select [Enable] in [Auto Turn Off].
Audio Receiver	System Audio Control	Connect audio equipment with the ARC function to the HDMI1 (ARC) terminal using the ARC-supported HDMI cable. The Volume buttons of the remote control can control the volume of the connected HDMI ARC audio equipment. While this function is active, the monitor's internal speakers are automatically set to MUTE.	In the OSD menu, go to [Setup] -> [HDMI Settings] -> [CEC] and select [Enable] in [Audio Receiver].
Device list	Device OSD Name Transfer	This function is used to obtain the name of the connected devices.	In the OSD menu, go to [Setup] -> [HDMI Settings] -> [CEC] -> [Device list] and press the ENTER button of the remote control.
	Routing Control	By selecting a device name, the HDMI-CEC compatible device input switches to the input you selected. After selecting the device, the remote control operates for the selected device.	

**NOTE:** Depending on the connected device, sometimes the device does not work properly.

# Internal Video Sources

## Media Player

The internal Media Player will play audio and video files that are stored on a USB storage device. The USB storage device connects to the terminal panel on the side of the display. See page 36 for instructions on using the Media Player.

### Compatible USB Storage Devices

If the USB storage device connected to the monitor is not recognized, check its format. The USB storage device used with the Media Player should be in the FAT32 or FAT16 format. For more information on how to format a storage device, see the manual or the help section of your Windows®.

Use a USB storage device of the correct size in accordance with the drawing below.

Connect the USB storage device to the USB Type-A port of the monitor.

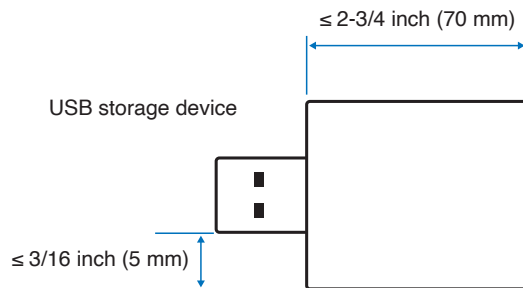

- NOTE:**
- The monitor is not guaranteed to work with all USB storage devices sold commercially.
  - Check that the USB storage device is connected to the USB Type-A port of the monitor.

### Attaching the USB flash drive cover

We recommend that you attach a USB memory cover to prevent theft.

1. Remove the screw at the position shown in the figure.

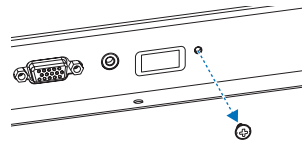

2. Insert the USB flash drive into the USB port.
3. Attach the USB flash drive cover and secure with the screw removed in step (1).

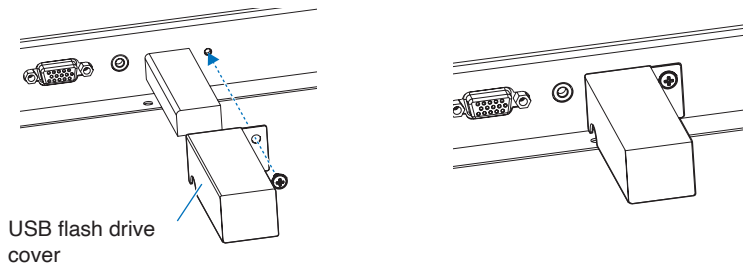

# Connecting a USB Device

---

Connect a USB storage device to the USB Type-A of the monitor as shown in the figure below to display images and videos using the Media Player function.

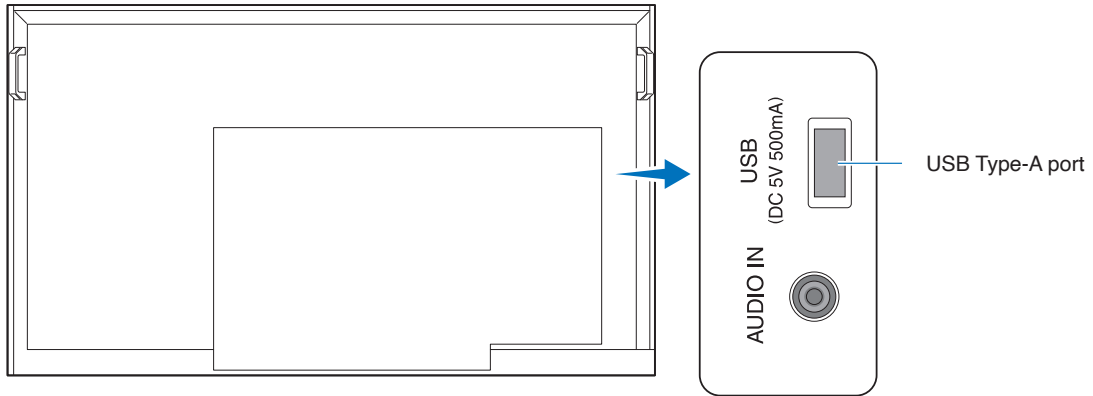

- NOTE:**
- Check the connector shape and orientation when connecting the USB device or cable.
  - Do not connect/disconnect a USB storage device to the monitor when the monitor is turned on. To prevent damage to the monitor and possible corruption of the connected device's data files, the monitor's main power switch should be off before making connections.

## Chapter 4 Basic Operation

### **This Chapter Includes:**

- ⇒ "Power On and Off Modes" on page 30
- ⇒ "Operating Range for the Remote Control" on page 32
- ⇒ "Showing the Information OSD" on page 33
- ⇒ "Switching Between Picture Modes" on page 33
- ⇒ "Setting the Aspect Ratio" on page 34
- ⇒ "OSD (On-Screen Display) Controls" on page 35
- ⇒ "Using the Media Player Menu" on page 36

# Power On and Off Modes

## Off mode

Off mode, when main power is off.

## Power indicator status

Mode	Normal operation (On mode)	Input signal waiting state	Standby state
Power indicator	Lit green	Flashing red	Lit red

## Energy Mode

The three following modes are available on the monitor.

"Home" is the recommended setting and conforms to the "Normal Configuration" as defined in the EcoDesign Regulation (2019/2021).

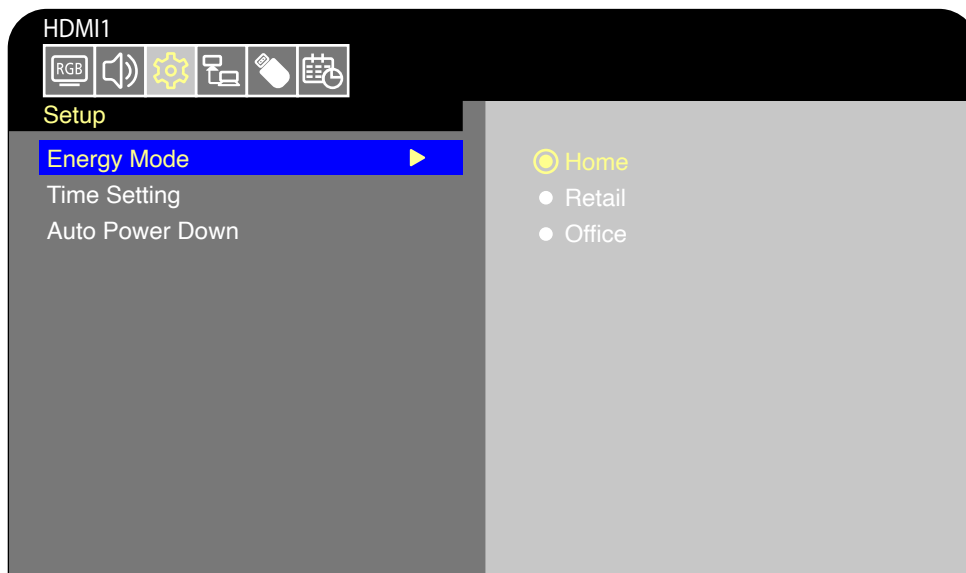

LAN and RS-232C can be selected for the monitor control. The way the energy modes operate varies depending on the selected control method.

**NOTE:** If the main power is off in the input signal waiting state of the Home mode or Office mode, the monitor enters standby state instead of the input signal waiting state when turning the power off and back on. It is necessary to turn the power on using the power button on this monitor or the POWER button on the remote control unit.  
Do not cover the power button or the remote control sensor when the monitor is installed.

## When [RS-232C] is selected for control

Standby state can be standby mode or networked standby mode, depending on the connected devices. Networked standby mode allows the monitor to be turned on via network (RS-232C and HDMI CEC).

## Home/Office mode

- When no signal is input, "No signal" is displayed and the monitor enters the Input signal waiting state after a while.
- When a signal is input into the selected input terminal, the On mode is resumed.

## Retail mode

- The monitor does not enter the input signal waiting state when no signal is input. (The On mode is maintained.)

## When [LAN] is selected for control

Standby state is networked standby mode.

Networked standby mode allows the monitor to be turned on via network (LAN and HDMI CEC).

In Home mode, if there is no LAN signal in networked standby mode, it will be in standby mode after 3 minutes.

### Home mode

- When no signal is input, "No signal" is displayed and the monitor enters the Input signal waiting state after a while.
- If no LAN signal is input during Input signal waiting state, the monitor enters the input signal waiting state in a low power after 3 minutes. You will not be able to connect to the LAN.
- When a signal is input into the selected input terminal, the On mode is resumed.

### Retail mode

- The monitor does not enter the input signal waiting state when no signal is input. (The On mode is maintained.)

### Office mode

- When no signal is input, [No signal] is displayed and the monitor enters the input signal waiting state. You will be able to connect to the LAN.
- When a signal is input into the selected input terminal, the On mode is resumed.

**⚠ WARNING:** If the monitor is not connected a LAN cable while in Home mode, the LAN will be turned off automatically. If you control with LAN again, connect the LAN cable to the monitor and then turn on the power.

# Operating Range for the Remote Control

Point the top of the remote control toward the monitor's remote control sensor during button operation.

The operation range of the remote control unit is approx. 16.4 feet (5 m) at an angle of approx 10° from the center to the top/bottom/right/left of the remote control sensor.

**NOTE:** The remote control system may not function when direct sunlight or strong illumination strikes the remote control sensor, or near fluorescent lamps.

## Handling the remote control

- Do not expose to strong shock.
- Do not allow water or other liquid to splash on the remote control. If the remote control gets wet, wipe it dry immediately.
- Avoid exposure to heat and steam.
- Ask your supplier or your municipality for information on how to dispose of the batteries.
- Do not open the remote control, except to install the batteries.

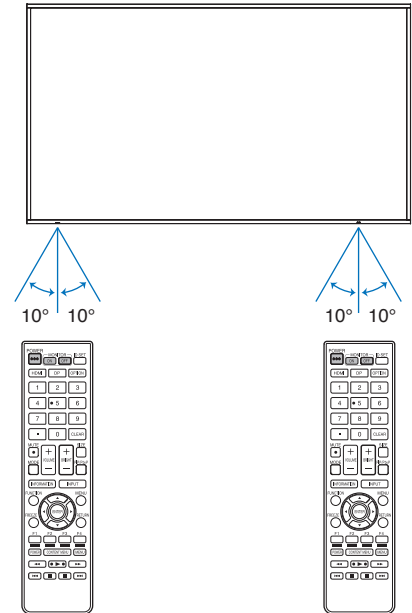

PN-HE751/PN-HC861/PN-HC751

PN-HE651/PN-HC651

# Showing the Information OSD

---

When the signal format changes during input switching, information such as the video input terminal, resolution information, and IP address is displayed.

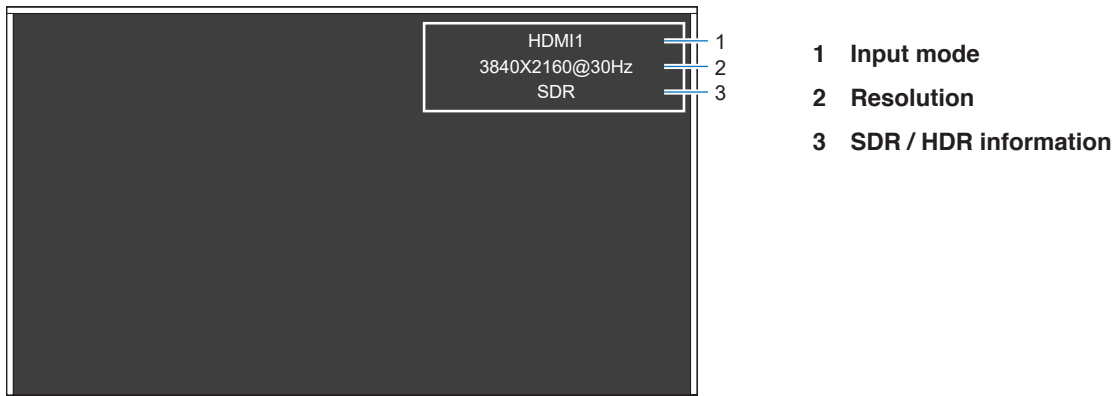

**NOTE:** When the Input mode is [Media Player], the information OSD will not be displayed.

# Switching Between Picture Modes

---

Press the MODE button of the remote control to change the Picture Mode setting between Dynamic, Standard, Conferencing, HighBright, Custom, and HDR Video\*.

\* HDR Video can be selected only when an HDR signal is input.

# Setting the Aspect Ratio

Press the SIZE button of the remote control to change the Aspect Ratio setting between Normal, 1:1, Full, and Zoom.

**NOTE:** This setting cannot be changed when [Media Player] is selected for the Input mode.

	Normal	1:1	Full	Zoom
<b>Video signal</b>	<p>The aspect ratio of the input signal is maintained and the image is enlarged/reduced.</p> <ul style="list-style-type: none"> <li>Black bars are added vertically or horizontally.</li> <li>The screen is not cut, neither vertically nor horizontally.</li> </ul>	<p>The image is displayed with the number of panel pixels corresponding to the resolution of the input signal. When the input signal is larger than the number of the panel pixels, the aspect ratio is maintained and the image is reduced.</p>	<p>The aspect ratio of the input signal is ignored and the image is enlarged.</p> <ul style="list-style-type: none"> <li>There are no black bars, neither vertically nor horizontally.</li> <li>The screen is not cut, neither vertically nor horizontally.</li> </ul>	<p>The aspect ratio of the input signal is maintained and the image is enlarged.</p> <ul style="list-style-type: none"> <li>There are no black bars, neither vertically nor horizontally.</li> <li>Part of the image, vertically or horizontally, is not displayed.</li> </ul>

**NOTE:** Note that changing the aspect ratio to compress or stretch an image and display it publicly or for commercial purposes in coffee shops, hotels, or other such places, may violate the rights of the copyright holder.

# OSD (On-Screen Display) Controls

The monitor features an OSD (On-Screen Display) function that allows the user to easily adjust the screen. By operating the menu displayed at the top of the screen, you will be able to adjust the brightness and the other screen settings.

**OSD screen structure** The OSD screen is composed of the following elements.

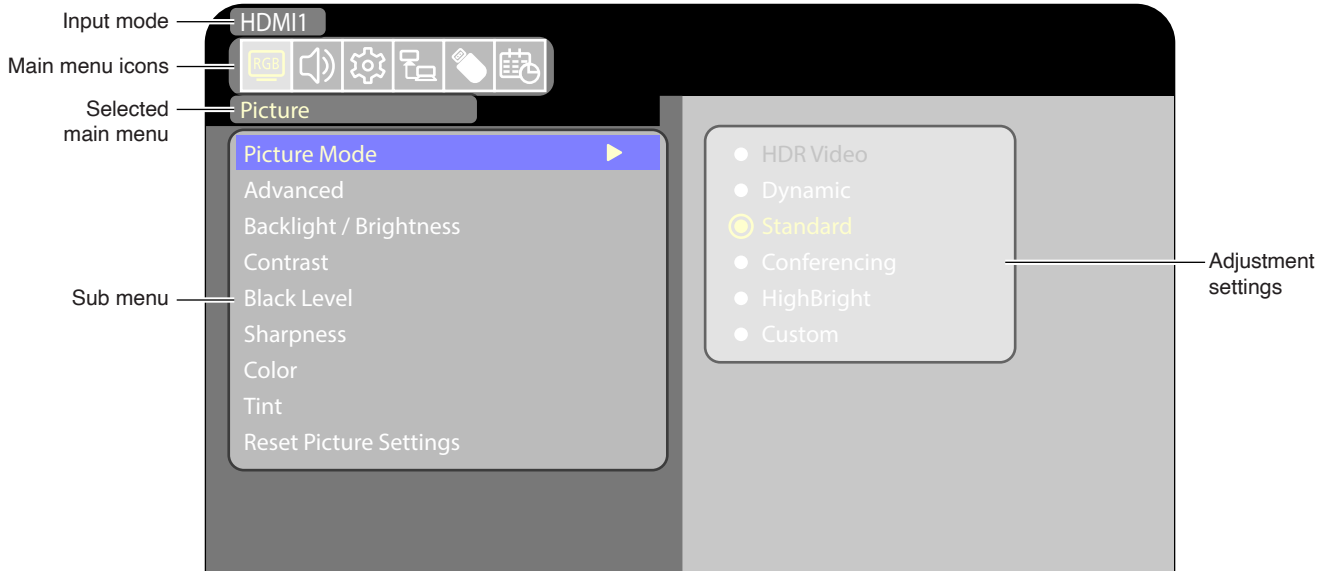

The function of each OSD menu element is briefly explained below. For more details on the content of the menu, see “OSD Controls List” (page 67).



**Picture settings:** Select one of the default picture modes, manually adjust the color settings, adjust the aspect ratio, and adjust the other settings related to the image.



**Audio settings:** Adjust the volume, balance, equalizer, and the other settings related to the audio.



**Setup settings:** Display the monitor information, select the language, or return the settings to their default values.



**Control settings:** Configure settings such as the network information.



**Media Player settings:** Configure the USB Demo Mode and other settings.



**Schedule setting:** Create auto power on/off schedules for the monitor and set the sleep timer.

# Using the Media Player Menu

The Media Player plays image, video, and music files located on a USB storage device connected to the USB Type-A port of the monitor (page 19).

To open the Media Player menu, press the INPUT button of the remote control and select [Media Player].

**NOTE:** Connect the USB storage device where the files are stored to the USB Type-A port of the monitor.

## Media Player Menu

This function can be used to display photos (still images) and play video and music files stored in the USB storage device.

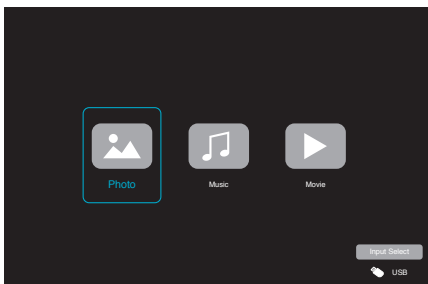

Select the type of the file you want to play between [Photo], [Music], and [Movie].

## Selecting Files to Play

- Playing a file  
Select a file using the ▲, ▼, ◀, and ▶ buttons of the remote control, and then press the ► (Play) button. Press the || button to pause the playback.
- Playing multiple files
  1. Select files using the ▲, ▼, ◀, and ▶ buttons of the remote control.
  2. Press the ENTER button of the remote control to add a checkmark next to each file.
  3. This saves the files as a playlist in the USB storage device.

**NOTE:**

- The selected files play in the order they are displayed in the folder.
- File names must contain only alphanumeric characters.

## Operation buttons

- Press the ENTER button of the remote control while playing a file to display the OSD operation menu on the screen.
- Press the ◀, ▶ buttons to highlight an item in the operation menu and then press the ENTER button to select it.
- Press the ▼ button of the remote control to close the operation menu.

## Slideshow Operation

- Select files using the ▲, ▼, ◀, ▶ buttons and press the ► (Play) button to start a slideshow. Press the || button to pause the slideshow.
- To pause the slideshow using the OSD menu, select ||. Select ► to resume the slideshow.
- Select ◀ or press the ◀◀ button of the remote control to return to the previous image.
- Select ▶ or press the ▶▶ button of the remote control to go to the next image.
- Select ■ or press the ■ button of the remote control to stop the slideshow.

## Repeat play

Repeat setting can be configured for file playback. The following modes can be selected.

 - Repeat off

- No selected files.
  - All files in the folder are played once, in the sorted order.
- One or more selected files.
  - Any files you checked are played once, in the sorted order.



 - Repeat one file

- - A file is playing: the current file plays on a loop. - No file is playing: the highlighted file in the folder plays on a loop.
- One or more selected files.
  - The first checked file in the sorted order plays on a loop.

 - Repeat all files

- No selected files.
  - All files in the folder are played on a loop, in the sorted order.
- One or more selected files.
  - The selected files are played on a loop, in the sorted order.

## Other functions

- Select  to view the playlist of files. You can also select the files to play from the list.
- While a file is being played, select  to show information on the file being displayed.

## Video and Music Operations

- Select files using the ▲, ▼, ◀, ▶ buttons of the remote control and press the ▶ (Play) button to start playback. Press the || button to pause the playback.
- To pause the playback using the OSD menu, select . Select to resume the playback.
- Select to start fast forward.  
**FF2X, FF4X, FF8X, FF16X, FF32X**  
(The sound is not output.)  
(FF32X can be selected only when a video file is played.)
- Select to start fast backward.  
**FB2X, FB4X, FB8X, FB16X, FB32X**  
(The sound is not output.)  
(FB32X can be selected only when a video file is played.)
- Select or press the ◀◀ button of the remote control to return to the previous file.
- Select or press the ▶▶ button of the remote control to return to go to the next file.
- Select or press the ■ button of the remote control to stop the playback.

## Repeat play

Repeat setting can be configured for file playback. The following modes can be selected.

### - Repeat off

- No selected files.
  - All files in the folder are played once, in the sorted order.
- One or more selected files.
  - Any files you checked are played once, in the sorted order.

### - Repeat one file

- - A file is playing: the current file plays on a loop. - No file is playing: the highlighted file in the folder plays on a loop.
- One or more selected files.
  - The first checked file in the sorted order plays on a loop.

### - Repeat all files

- No selected files.
  - All files in the folder are played on a loop, in the sorted order.
- One or more selected files.
  - The selected files are played on a loop, in the sorted order.

## Other functions

- Select to view the playlist of files.  
You can also select the files to play from the list.
- While a file is being played, select to show information on the file being played.  
**NOTE:**
  - Only use USB mass storage class devices.
  - We cannot guarantee to support all commercially-available USB mass storage devices.
  - Do not use a USB hub.
  - Do not use a multi-partition USB storage device.
  - The USB Type-A port of the monitor supports 5 V / 500 mA. When using a USB device of more than 500 mA, we recommend using the AC adapter supplied with the USB device.
  - When connecting a USB device formatted as FAT16 or FAT32 to a computer, a message prompting you to scan and fix the USB device may appear. If that occurs, execute “Scan and fix”.

## Data Format for USB

<b>Supported file system</b>	FAT16 (max 2 GB), FAT32 (max 4 GB)		
<b>Max folder level</b>	9		
<b>Max number of photos</b>	997		
Photo mode			
File extension	Data format	Min resolution (H x V) of image	Max resolution (H x V) of image
JPEG, JPG, JPE	Baseline JPEG	75 x 75 pixels	15,360 x 8,640 pixels
Music mode			
File extension	Data format	Max bit rate	Max channel No.
MP3	MPEG1/2 Layer3 (MP3)	320 kbps	2 ch
Movie mode			
Container format	Supported video codec		Supported audio codec
MPG, MPEG	MPEG1, MPEG2, MPEG4		LPCM, MP3, AAC
TS	MPEG2, H.264, HEVC/H.265		LPCM, MP3, AAC
MP4	MPEG2, MPEG4, H.263, H.264, HEVC/H.265		LPCM, MP3, AAC
Video codec	Max bit rate of video* <sup>2</sup>	Max resolution (H x V) of video	
MPEG1	40 Mbps	1920 x 1080 @30 Hz	
MPEG2	40 Mbps	1920 x 1080 @30 Hz	
MPEG4	40 Mbps	1920 x 1080 @30 Hz	
H.263	40 Mbps	1920 x 1080 @30 Hz	
H.264	135 Mbps	3840 x 2160 @60 Hz	
HEVC/H.265	100 Mbps	3840 x 2160 @60 Hz	
Audio codec	Max bit rate of audio* <sup>2</sup>	Max channel No.	
LPCM	1.5 Mbps	5.1 ch* <sup>1</sup>	
MPEG1/2 Layer3 (MP3)	320 kbps	2 ch	
AAC	AAC-LC: 576 kbps HE-AAC v1: 288 kbps HE-AAC v2: 144 kbps	5.1 ch* <sup>1</sup>	

\*1: It is played with down-converted to 2 ch.

\*2: It may not play smoothly with a combination of max bit rate of video and audio.

- NOTE:**
- Sometimes, it may not be possible to play a video file even when the conditions above are met. The file may not be played properly depending on the bit rate. Video files made with a codec not supported by the monitor cannot be played.
  - Supported color format is YUV only. RGB and CMYK color format files can not be played correctly.
  - When playing a slideshow, please use YUV 4: 2: 0 image format files.

# Chapter 5 Advanced Operation

## **This Chapter Includes:**

- ⇒ "Creating a Power Schedule" on page 40
- ⇒ "Using Picture Modes" on page 41
- ⇒ "Setting Security and Locking the Monitor Controls" on page 42
- ⇒ "Locking the Button Controls" on page 43

# Creating a Power Schedule

The schedule function allows the monitor to automatically switch between power on and standby state at different times.

## To program the schedule:

1. Enter the [SCHEDULE] menu in the OSD menu.
  - a. Use the ▲/▼ buttons of the remote control to select [Current Time settings].
  - b. Press the ENTER button of the remote control. Press the ◀, ▶ buttons of the remote control to move between the hours and minutes fields.
  - c. Use the ▲/▼ buttons of the remote control to set the time.
2. After setting the time, press the MENU button of the remote control.
3. Use the ▲/▼ buttons of the remote control to select [Power settings].
  - a. Press the ENTER button of the remote control. Place the cursor on [Power On] and press the ENTER button of the remote control to enable the [Power On]. Press the ◀, ▶ buttons of the remote control to move between the hours and minutes fields.  
Use the ▲/▼ buttons of the remote control to set the time.

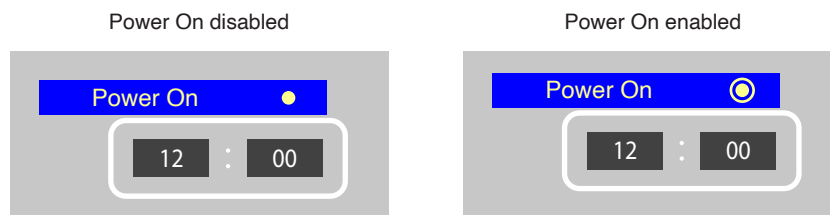
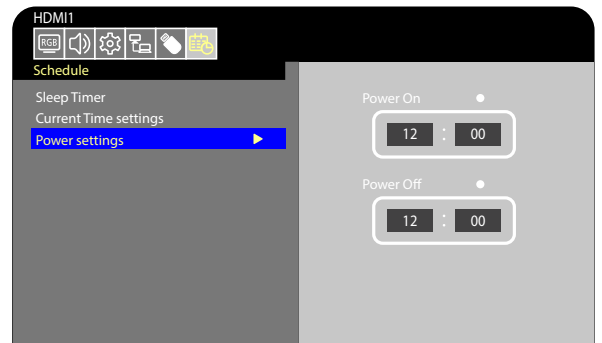

- b. Use the ◀, ▶ buttons of the remote control to place the cursor on [Power Off] and then press the ENTER button of the remote control to enable [Power Off]. Press the ◀, ▶ buttons of the remote control to move between the hours and minutes fields.  
Use the ▲/▼ buttons of the remote control to set the time.

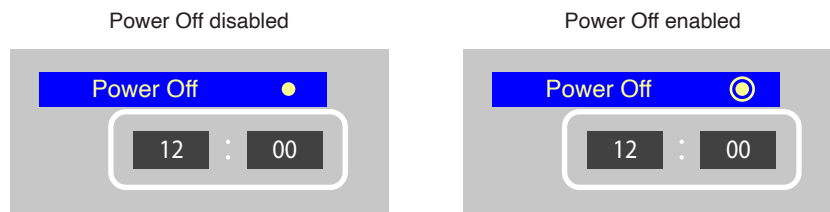

4. After setting the schedule, press the MENU button or RETURN button to return to the previous OSD menu.

# Using Picture Modes

---

There are different picture modes available. They have been configured for different applications as described in the “Picture Mode Types” table below.

## To change picture modes:

In the OSD menu, go the [Picture] -> [Picture Mode], or press the MODE button of the remote control to select a mode.

HDR Video -> Dynamic -> Standard -> Conferencing -> HighBright -> Custom



## Picture Mode Types

Picture Mode	Purpose
HDR Video	Setting for HDR format video (can be selected only when an HDR signal is input)
Dynamic	High-contrast video setting
Standard	Standard video setting
Conferencing	Video setting suited for video conferences
HighBright	Video setting suited for brighter environments
Custom	Customizable settings

# Setting Security and Locking the Monitor Controls

---

Under normal operation, the monitor can be controlled by any person using the remote control or the monitor control panel. You can prevent unauthorized use and changes to the monitor settings by enabling the security and lock settings.

The security and locking functions covered in this section are:

- Locking the monitor control panel buttons
- Locking the remote control buttons

## Locking the Button Controls

---

The lock settings prevent the monitor from responding to button presses on the remote control or monitor control panel. When locking the button controls, some buttons can be configured to remain unlocked.

## Locking the Control Panel Buttons

---

The [Key Lock Settings] prevent the monitor from being controlled using the buttons on the monitor control panel.

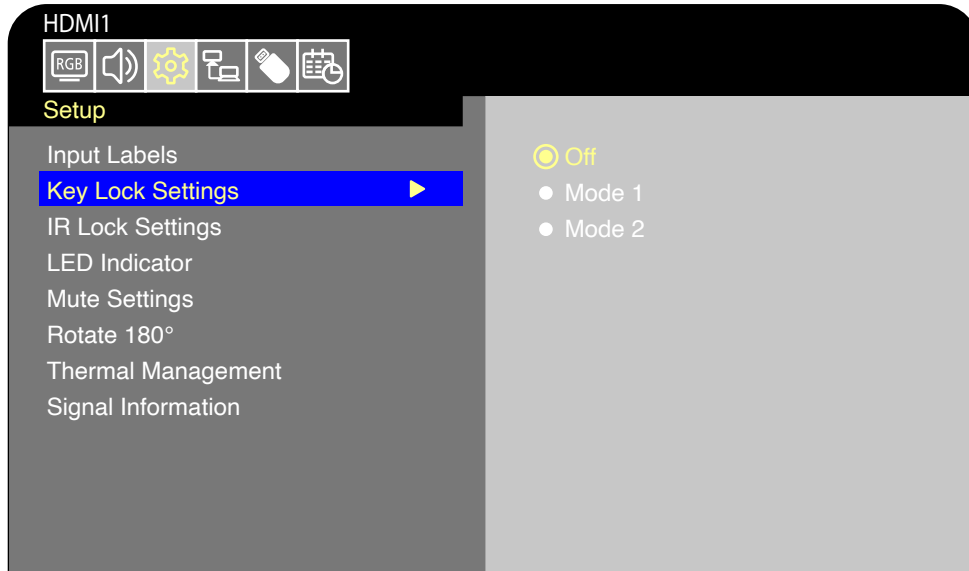

1. In the OSD menu, go to [Setup] -> [Other settings] and select [Key Lock Settings].
  2. Select the key lock range.
    - **Off:** All buttons operate normally.
    - **Mode1:** Only the power button and the Input mode switching function operate.
    - **Mode2:** All buttons are locked. (Only the power button can be used during standby state.)
- NOTE:** The buttons are locked 3 seconds after Mode1 or Mode2 has been selected.

## Unlocking the Monitor Panel Button Controls

Carry out the following with the monitor in On mode.

- **OSD menu:** To remove the lock and restore normal button operation, set the [Key Lock Settings] to [Off] using the remote control.
- **Monitor buttons:** To remove the lock and restore normal button operation, hold the MENU button pressed for 5 seconds or more.

## Locking the Remote Control Buttons

The [IR Lock Settings] prevent the monitor from being controlled using the remote control.

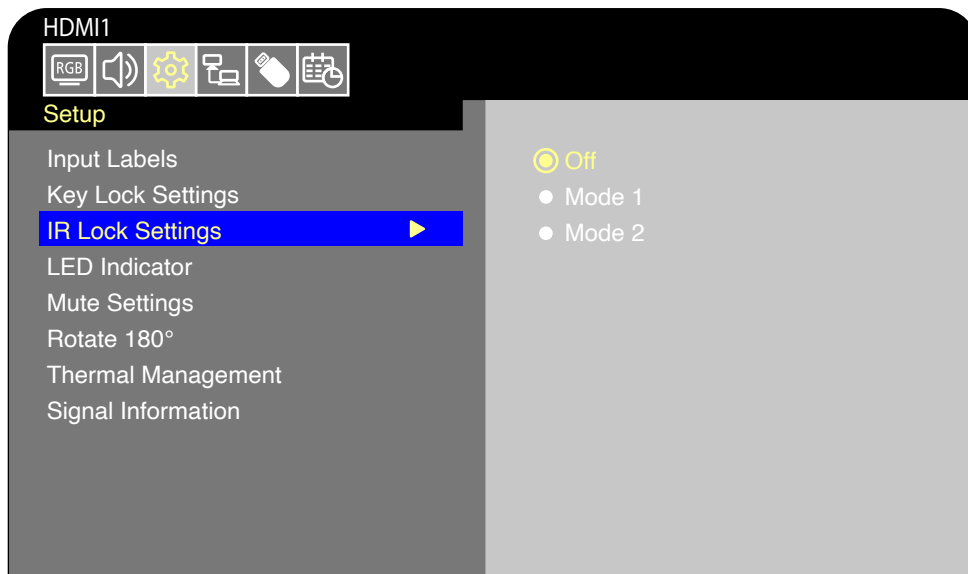

1. In the OSD menu, go to [Setup] -> [Other settings] and select [IR Lock Settings].
2. Select the key lock range.

- **Off:** All buttons operate normally.
- **Mode1:** Only the POWER and the INPUT buttons operate.
- **Mode2:** All buttons are locked. (Only the POWER button can be used during standby state.)

**NOTE:** The buttons are locked 3 seconds after Mode1 or Mode2 has been selected.

## Unlocking the Remote Controls

Carry out the following with the monitor in On mode.

- **OSD menu:** To remove the lock and restore normal button operation, set the [IR Lock Settings] to [Off] using the monitor buttons.
- **Remote control:** To remove the lock and restore normal button operation, hold the RETURN button pressed for 5 seconds or more.

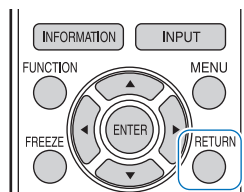

## Chapter 6 External Control

### This Chapter Includes:

- ⇒ "Controlling the Monitor via RS-232C" on page 46
- ⇒ "Controlling the Monitor via LAN" on page 47
- ⇒ "HTTP Browser" on page 49
- ⇒ "Commands" on page 51

### Connecting an external device

There are two options to connect an external device to control the monitor.

- Connection via RS-232C  
Connecting an external device with the RS-232 cable of the monitor.
- Network (LAN) Interface  
Connecting a network to the LAN port of the monitor with a LAN cable.

# Controlling the Monitor via RS-232C

This monitor can be controlled by connecting a personal computer with an RS-232C terminal to the RS-232C terminal of the monitor with a commercially-available RS-232C crossover cable.

**NOTE:** Set [Control Interface] under [Control Settings] to [RS-232C] (page 73).

## Connection

Monitor + computer.

- Turn off the monitor and the computer before connecting a computer to the monitor.
- First, turn the computer on, and then turn the monitor on.
- To control the monitor via commands sent from a computer connected with an RS-232 cable, use the control commands. Instructions for the control commands can be found in “Commands” in “External Control” in this manual.

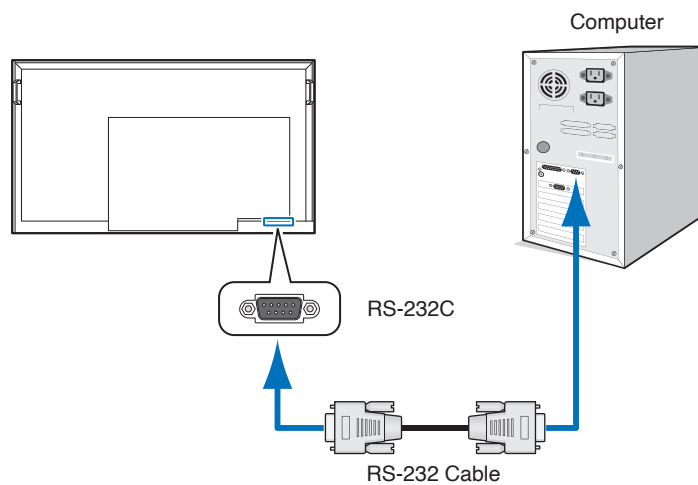

- NOTE:**
- If your computer is equipped only with a 25-pin serial port connector, a 25-pin serial port adapter is required.
  - Contact your supplier for details.
  - For the pin assignment, see “Pin Assignment RS-232C input/output”.

This monitor uses RXD, TXD and GND lines for RS-232C control.

A commercially-available crossover cable (not included) should be used for RS-232C control.

## Pin Assignment

RS-232C input / output

Pin No	1	2	3	4	5	6	7	8	9
Name	NC	RXD	TXD	NC	GND	NC	NC	NC	NC

D-sub 9-pin (monitor side)

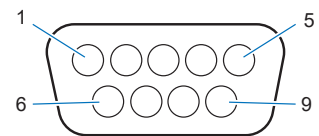

This monitor uses RXD, TXD and GND lines for RS-232C control.

# Controlling the Monitor via LAN

## Connect the monitor to the network

The monitor is equipped with a LAN port (RJ-45). Connecting the monitor to a network allows you to control the monitor from a computer via a network. To use a LAN connection, you are required to assign an IP address to the monitor (page 73). The monitor will obtain an IP address automatically when connected to a DHCP network.

### Example of LAN connection

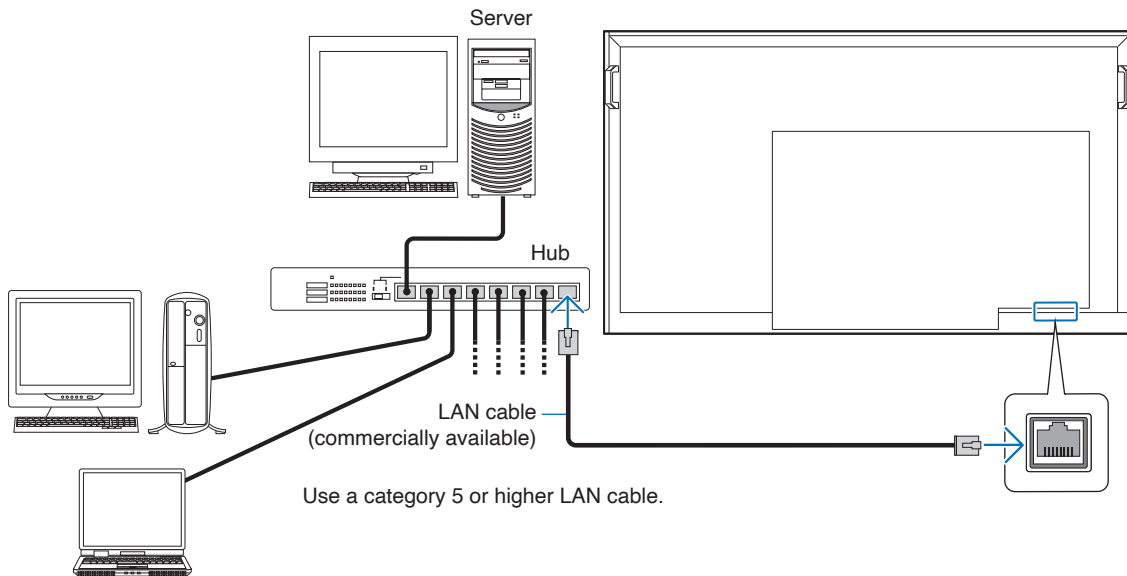

To enable command control via LAN on the monitor, check the settings on both the [Control Interface] in the OSD menu and TCP settings in the web browser.

## Change the control interface to LAN with MENU

Set [Control Interface] under [Control Settings] to [LAN] (page 73).

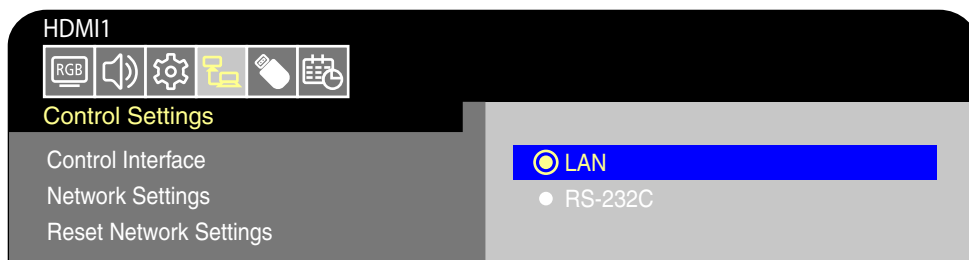

## Enable TCP connection in a web browser

Command access is disabled by default. Access the display in a web browser and select Enabled in TCP.

1. Check the IP address of the monitor.  
Press the INFORMATION button twice and check the IP address on INFORMATION 2.

INFORMATION2	
Control Interface	LAN
DHCP	On
IP ADDRESS	XXX. XXX. XXX. XXX
SABNET MASK	255. 255. 255. 0
DEFAULT GATEWAY	0. 0. 0. 0
DNS PRIMARY	0. 0. 0. 0
DNS SECONARY	0. 0. 0. 0
MAC ADDRESS	XX:XX:XX:XX:XX:XX

2. Launch the web browser on your computer and access the display.  
URL: http://<Address IP of the monitor>

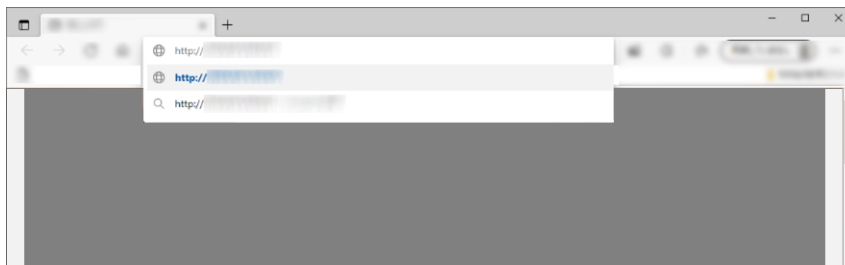

3. Log in.  
Initial password: admin

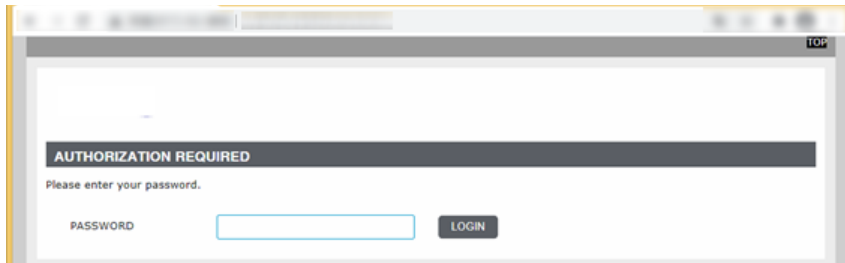

4. Change password (first access)  
For the first access, you will be asked to change your password.  
Enter the password in [PASSWORD] and [CONFIRMATION] and click [SAVE].

TCP	<h3>PASSWORD SETTINGS</h3> <p>Changes the administrator password for accessing the device</p> <table border="1"> <tr> <td>PASSWORD</td> <td>.....</td> </tr> <tr> <td>CONFIRMATION</td> <td>.....</td> </tr> </table> <p style="text-align: right;"><b>SAVE</b></p>	PASSWORD	.....	CONFIRMATION	.....
PASSWORD		.....			
CONFIRMATION		.....			
NAME					
<b>NETWORK</b>					
SYSTEM					
LOGOUT					

5. Enable TCP.  
Check ENABLE and click [SAVE]. Do not change the PORT number to anything other than 10008.

<b>PROTOCOL</b>	<h3>TCP SETTINGS</h3> <table border="1"> <tr> <td>TCP</td> <td><input checked="" type="checkbox"/> ENABLE <input type="checkbox"/> DISABLE</td> </tr> <tr> <td>CONFIRMATION</td> <td>10008</td> </tr> </table> <p style="text-align: right;"><b>SAVE</b></p>	TCP	<input checked="" type="checkbox"/> ENABLE <input type="checkbox"/> DISABLE	CONFIRMATION	10008
TCP		<input checked="" type="checkbox"/> ENABLE <input type="checkbox"/> DISABLE			
CONFIRMATION		10008			
TCP					
NAME					
NETWORK					
SYSTEM					
LOGOUT					

# HTTP Browser

---

## Overview

Connect the monitor with a commercially-available LAN cable to configure the LAN settings using the HTTP server function.

This monitor uses “JavaScript” and “Cookies” and the browser should be set to accept these functions. Refer to the help files for the Web browser to change the settings to use JavaScript and Cookies.

To access the HTTP server, launch a web browser on a computer connected to the same network as the monitor and enter the following URL in the Web address field.

## Network Settings

http://<Address IP of the monitor>

Ex) When the IP address of the monitor is "192.168.73.1"  
To access the network settings, specify http://192.168.73.1/index.html  
in the address or URL input field.

- NOTE:**
- By default, the IP address of the monitor is set automatically. After a reset, the IP address is obtained automatically.
  - Depending on the network environment, the display speed and response to commands or clicks on buttons may be slow, or the operations may not be recognized. In such a case, consult your network administrator. The monitor may not respond if the buttons shown on the browser are repeatedly pressed in rapid intervals. In such a case, wait a moment and try again. If you still can't get a response, turn the monitor off and then back on.
  - If the monitor Network Settings screen does not appear in the Web browser, press the Ctrl+F5 keys to refresh your Web browser. If the screen does not appear, clear the cache of the Web browser.

## Preparation Before Use

Connect the monitor to the network using a commercially-available LAN cable before attempting to use browser operations.

Set [Control Interface] under [Control Settings] to [LAN] (page 73). Operation with a browser that uses a proxy server may not be possible depending on the type of proxy server and the setting method. Although the type of the proxy server will be a factor, it is possible that items that have been set will not be shown depending on the effectiveness of the cache, and the settings configured from the browser may not be reflected in operation. It is recommended that a proxy server is not used unless the network environment requires it.

## Access by Web browser

Access the following address to show HOME. Click the links on the left-hand column on the HOME screen to access the setting screens.

http://<Address IP of the monitor>

The default login password is “admin”.

After logging in, the password change screen will be displayed. When you change the password, the setting menu will be displayed.

## OSD Menu Settings in the Monitor Web Controls

The functions related to the network can be configured the same way as in the OSD menu using the links below.

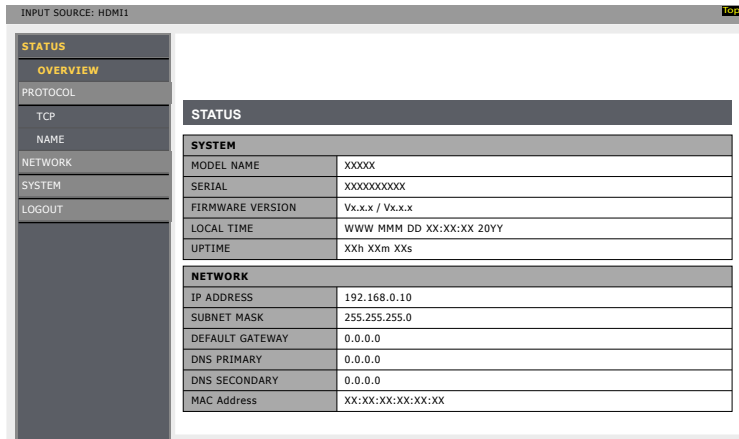

## Network Settings

Click on “NETWORK” on the left-hand column on the HOME screen to enter the setting screen.

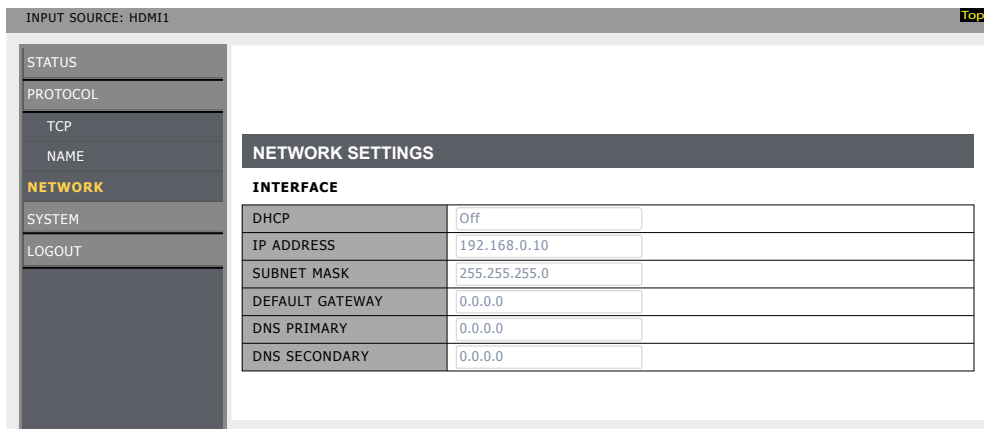

DHCP	<p>Select a method for setting the IP ADDRESS.</p> <p>Off: Sets fixed network settings.</p> <p>On: Obtains the network settings from the DHCP server on the network.</p> <p>Manual DNS: Obtains the network settings from the DHCP server on the network but the DNS is set manually.</p> <p><b>NOTE:</b> Consult your network administrator if you have any trouble with the connection.</p>
IP ADDRESS	Set the IP address for the monitor connected to the network when [Off] is selected for [DHCP].
SUBNET MASK	Set the subnet mask for the network to which the monitor is connected when [Off] is selected for [DHCP].
DEFAULT GATEWAY	Set the default gateway for the network to which the monitor is connected when [Off] is selected for [DHCP]. Enter [0.0.0.0] to delete the setting.
DNS PRIMARY	Enter the IP address of the primary DNS server of the network connected to the monitor. <b>NOTE:</b> Enter [0.0.0.0] to delete the setting.
DNS SECONDARY	Enter the IP address of the secondary DNS server of the network connected to the monitor. <b>NOTE:</b> Enter [0.0.0.0] to delete the setting.

# Commands

Connecting the monitor to a computer via RS-232C or to a network via LAN allows for the transmission of commands to the monitor, providing remote control of the monitor from a connected device. For the commands, refer to "RS-232C command table" on page 77 of this manual.

## Controlling the Monitor with a computer (RS-232C)

You can control this monitor from a computer via RS-232C (COM port) on the computer.

### Communication conditions

Set the RS-232C communication settings on the computer to match the monitor's communication settings as follows:

BAUD RATE	9600 [bps]
DATA LENGTH	8 [bits]
PARITY	NONE

STOP BIT	1 [bit]
FLOW CONTROL	NONE

### Communication procedure

#### Command format

When a command is sent from the computer to the monitor, the monitor operates according to the received command and sends a response message to the computer.

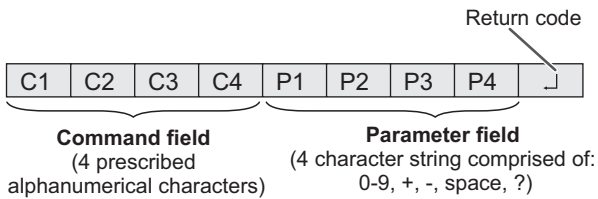

Example: VOLM0030  
VOLM \_ \_ 30

- \* Be sure to input 4 characters for the parameter. Pad with spaces (" ") if necessary. ("␣" is a return code (0DH, 0AH or 0DH))  
Wrong : VOLM30␣  
Right : VOLM \_ \_ 30␣

When the parameter part is 5 or more characters, specify parameters using a specified number of characters without using spaces.

Example: PASS012345

If a command has "R" listed for "Direction" in the "RS-232C command table" on page 77, the current value can be returned by using "?" as the parameter.

Example:

```
VOLM ? ? ? ? ← From computer to monitor
                (How much is current volume
                setting?).

30 ← From monitor to computer
    (Current volume setting: 30).
```

#### Response code format

##### When a command has been executed correctly

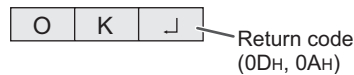

A response is returned after a command is executed.

##### When a command has not been executed

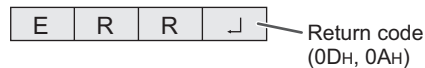

- NOTE:**
- "ERR" is returned when there is no relevant command or when the command cannot be used in the current state of the monitor.
  - If communication has not been established for reasons such as a bad connection between the computer and monitor, nothing is returned (not even ERR).
  - "ERR" may be returned when a command cannot be received correctly due to interference from the surrounding environment. Please ensure that the system or software resends the command if this occurs.

### Communication interval

- The transmission time interval of command should be within 100 ms.
- After “OK” or “ERR” is returned, you must send the following commands.  
To set a timeout for the command response, specify 10 seconds or longer.
- Provide an interval of 100 ms or more between the command response and the transmission of the next command.

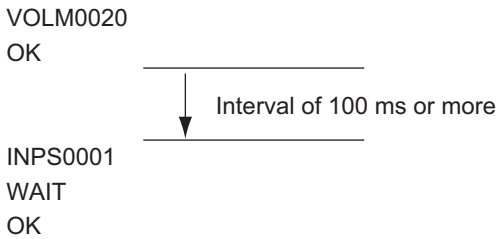

- NOTE:**
- Before sending a power “On” or “Off” command, it is recommended that you perform buffer clear at the sending application side.
  - If you send the following command, wait a specified interval after receiving the command response, and then send the next command.
    - All reset command: :Approx. 30 seconds
    - Power “On” or “Off” command: Approx. 15 seconds
    - Input mode selection command: Approx. 10 seconds

### Controlling the Monitor with a computer (LAN)

You can control the monitor using RS-232C commands (see page 77) via terminal software and other appropriate applications.

Set the TCP connection to enable in a web browser. (see page 48)

Read the manual for the terminal software for detailed instructions.

### Communication conditions

Set the LAN communication settings on the computer to match the monitor’s communication settings as follows:

Item	Details
PROTOCOL	TCP
PORT NUMBER	10008 (Cannot be changed)
COMMUNICATION SPEED	AUTO setting (10/100Mbps)

#### (1) Connect the computer to the monitor.

1. Specify the IP address and port number and connect the computer to the monitor.  
When connection has been established successfully, [Login] is returned as response.
2. Send the user name.(see page 78)
  - Send [user name] + [□].
  - If the user name is not set, send [□].
  - When the transmission is successful, [□ Password] is returned as response.
3. Send the password.(see page 78)
  - Send [password] + [□].
  - If the password is not set, send [□].
  - When the transmission is successful, [OK □] is returned as response.

#### (2) Send commands to control the monitor.

- The commands used are the same as those for RS-232C. Refer to the communication procedure (see page 51) for operation.

- Usable commands are provided in the RS-232C command table (see page 77).

#### (3) Disconnect the connection with the monitor and quit the function.

1. Send [BYE □].  
When the transmission is successful, [Goodbye □] is returned and the connection is disconnected.

**NOTE:** If there is no signal for approx. 5 minutes, the connection is disconnected.  
“Login user name” and “password” for LAN control is empty by default.

# Chapter 7 Troubleshooting

## **This Chapter Includes:**

- ⇒ "When a problem occurs with the monitor" on page 54
- ⇒ "Nothing is displayed" on page 54
- ⇒ "The image is not displayed correctly" on page 55
- ⇒ "An instruction or caution screen is displayed" on page 56
- ⇒ "Others (when connected to a computer)" on page 56
- ⇒ "Others (remote control, speakers)" on page 56
- ⇒ "Others (when connected via RS-232C or LAN)" on page 57
- ⇒ "When using a media player" on page 57
- ⇒ "When using a video device" on page 57

# When a problem occurs with the monitor

In such a case, refer to the following.

## Nothing is displayed

Symptom	Condition	Cause and solution	Reference
<b>Nothing is displayed on the screen.</b>	The power indicator is off In the OSD menu, [Setup] -> [Other Settings] -> [LED Indicator] is set to [On]	Check that the power cord is properly connected.	P.8
		Use another device to check that power is correctly supplied to the outlet.	
	The power indicator is lit green	A terminal to which no signal is input may be selected. Press the input switch button to select a different input terminal.	P.18
		Display the OSD menu and check the following settings.	P.35
		<ul style="list-style-type: none"> <li>If the OSD menu does not appear, the monitor may malfunction. Please contact an authorized SHARP servicing dealer or service center for assistance.</li> </ul>	
		<ul style="list-style-type: none"> <li>If the OSD menu is displayed properly, the monitor is not malfunctioning. Adjust [Backlight / Brightness] and [Contrast] in the [Picture] settings.</li> </ul>	P.69
	The power indicator is flashing red	<ul style="list-style-type: none"> <li>If the image is not displayed after adjusting [Backlight / Brightness] and [Contrast] in the OSD menu, check that the connected device operates correctly. If the monitor is connected to a computer, check the frequency, resolution, and type of output signal on the computer.</li> </ul>	P.23
		The power management function may be functioning. Press any button on the keyboard, move the mouse, or press the POWER button on the power cable or the remote control.	P.20, P.30
		Check that the signal cable is correctly connected to the input and output terminals of the monitor and the connected device.	P.22
		Check that the power adaptor is properly connected.	P.23
	Check that the connected computer or video device is turned on.		
<b>The image on the screen disappeared.</b>	The screen, on which the image was correctly displayed, turned black, started to blink, or did not display anything.*	The LCD panel needs to be replaced. Please contact an authorized SHARP servicing dealer or service center for assistance.	



\* If there is no input signal, the power LED flashes red.

\* The lifespan of the backlight used in the monitor may end.

## The image is not displayed correctly

Symptom	Cause and solution	Reference
<b>Black dots (dots not lit) or bright dots (dots always lit) appear on the screen.</b>	This is due to the characteristics of LCD panels and is not a malfunction.	
<b>The brightness of the image is not even.</b>	This may happen depending on the content displayed. This is due to the characteristics of LCD panels and is not a malfunction.	
<b>The shadow of thin vertical lines appears on the screen.</b>	This may happen depending on the content displayed. This is due to the characteristics of LCD panels and is not a malfunction.	
<b>Moiré appears when detailed patterns are displayed.</b>	This may happen when detailed patterns are displayed. This is due to the characteristics of LCD panels and is not a malfunction.	
<b>The colors do not look correct depending on the viewing angle.</b>	The tint may greatly vary depending on the viewing angle (the angle from which the screen is viewed).	P.61-64
<b>The display condition of the screen is changing gradually.</b>	The display condition changes gradually while the monitor is being used. The ambient temperature may also have an impact on the display condition. This is due to the characteristics of LCD panels and is not a malfunction.	P.20
<b>After changing the screen, the image of the previous screen remains slightly.</b>	When the same still image is displayed for a long time, this phenomenon of persisting image may occur. You may press the POWER button of the remote control or the  of the monitor to put the monitor on standby state, or display changing images for about one day until the persisting image disappears naturally. If the still image is displayed for a really long time without putting the monitor on standby state or switching to the changing image, the persisting image may not disappear. This is not a malfunction. It is recommended to switch input mode to standby state or turn the monitor off when not using it. If you are concerned about persisting image, you can gradually eliminate persisting image by reducing the setting value of "Picture" -> "Contrast" in the OSD menu. (Initial setting value: 50)	
<b>The colors are not displayed correctly.</b>	Display the OSD menu and check the following settings.	P.35
	<ul style="list-style-type: none"> <li>● If the OSD menu is not displayed properly, the monitor may malfunction. Please contact an authorized SHARP servicing dealer or service center for assistance.</li> </ul>	
	<ul style="list-style-type: none"> <li>● If the OSD menu is displayed properly, the monitor is not malfunctioning. Select [Color] and adjust the colors as needed, or execute [Reset Picture Settings] under the [Picture] settings to return the settings to their default values.</li> </ul>	P.69
<b>The image is not displayed correctly (problems not mentioned above) or the video is interrupted momentarily.</b>	The image quality may decrease or the video may be interrupted if a transponder, a splitter, or a long cable is used. Replace the cable you are using with a shielded cable, or connect directly to the monitor without using a splitter. Noise may also appear on the screen or the video may be interrupted depending on the usage environment and the cable used.	
	Display the OSD menu and check the following settings.	P.35
	<ul style="list-style-type: none"> <li>● If the OSD menu is not displayed properly, the monitor may malfunction. Please contact an authorized SHARP servicing dealer or service center for assistance.</li> <li>● If the video is interrupted when an HDMI signal with the 3840 x 2160 or 4096 x 2160 resolution is input, use an HDMI cable supporting 4K.</li> </ul>	
<b>The power turns off automatically.</b>	Check the setting in [Setup] -> [Power save settings] -> [Auto Power Down]. Set the [CEC] setting under [Setup] -> [HDMI Settings] to [Off]. Check the setting in [Schedule] -> [Sleep Timer].	P.71, P.75
<b>The monitor does not operate according to the schedule function.</b>	Check the setting in [Schedule] -> [Current Time settings]. Enable [Power On] under [Schedule] -> [Power settings]. Enable [Power Off] under [Schedule] -> [Power settings].	P.75
<b>The display is disturbed.</b>	The display may be disturbed when power is turned on or when the settings have been changed. This is not a malfunction.	

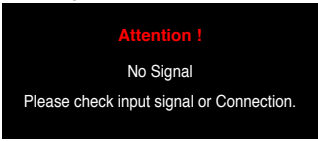
## An instruction or caution screen is displayed

Symptom	Cause	Solution	Reference
<b>A caution message is displayed on the screen.*1</b> 	The signal cable may not be connected properly to the input or output terminals of the monitor or the computer.	Connect properly the signal cable to the input and output terminals of the monitor and the computer.	P.22
	The HDMI input may have switched.	Set the [CEC] setting under [Setup] -> [HDMI Settings] to [Off].	P.71
	The signal cable may be damaged.	Check that the signal cable is not damaged.	
	The computer may be turned off.	Check that the computer is turned on.	
	The power management function of the computer may be functioning.	Move the mouse or press a key on the keyboard.	
	An improper signal may be input to the monitor.	Change the frequency of the input signal or the resolution of the computer.	P.59
	A signal with a resolution higher than the resolution supported by the monitor may be input.	Change the frequency of the input signal or the resolution of the computer.	P.59
<b>A temperature warning is displayed on the screen.</b> 	The ambient temperature exceeds the operation guaranteed temperature.	Turn off the power of the monitor since this problem may cause a malfunction.	P.72

\*1 Depending on the computer, a proper signal may not be output immediately after changing the resolution or the frequency and the caution may be displayed for a while. In such a case, wait for a while. If the screen display returns to normal, it means the input signal is proper.

## Others (when connected to a computer)

Symptom	Cause	Solution
<b>I cannot change the resolution or the number of colors/The resolution or the number of colors is fixed.</b>	Sometimes, the signal cannot be input and output.	Restart the monitor and the computer.
	The driver of the video card may not be correctly recognized by the OS.	Reinstall the video card driver. For more information on the reinstallation procedure, refer to the computer manual or the support service for the computer.

## Others (remote control, speakers)

Symptom	Cause and solution	Reference
<b>The remote control is not functioning.</b>	<ul style="list-style-type: none"> <li>The batteries may be flat.</li> <li>Check that the batteries are inserted correctly (check the + and - sides).</li> <li>The [IR Lock Settings] may be set to [Mode 1] or [Mode 2].</li> </ul>	P.7, P.72
<b>The video is displayed but there is no sound.</b>	<ul style="list-style-type: none"> <li>Check that the audio cable is correctly connected. Check also that the audio balance is not fully set to one side only. If the balance is set to one side only, set it to the center.</li> <li>The sound may be muted. Press the MUTE button on the remote control and check that the sound is output.</li> <li>The volume may be set to the minimum. Adjust the volume using the + and - buttons on the main unit or the VOLUME button +/- (Volume adjustment) on the remote control.</li> </ul>	P.19, P.20, P.70

### Others (when connected via RS-232C or LAN)

Symptom	Cause and solution	Reference
<b>Control via RS-232C is not available.</b>	Check that the RS-232C crossover cable is correctly connected.	P.46
<b>Control via LAN is not available.</b>	Check that the LAN cable (Cat.5 or higher) is correctly connected.	P.47
	Check that the Network Settings are correctly configured.	P.47

### When using a media player

Symptom	Cause and solution	Reference
<b>The media player function does not recognize the USB storage device.</b>	Check that a USB storage device is correctly connected to the USB port.	P.27

### When using a video device

Symptom	Cause and solution	Reference
<b>There is no image and no sound.</b>	Check that the external device (video player, etc.) is correctly connected and operates properly. For more information, see the manual of the external device.	P.22
	The power management function of the monitor may be functioning. Check that the external device is operating (playing).	
<b>There is no color or the colors are abnormal.</b>	Adjust the [Color] setting.	P.69

## Chapter 8 Specifications

### **This Chapter Includes:**

- ⇒ "Compatible Signal List" on page 59
- ⇒ "PN-HE751" on page 61
- ⇒ "PN-HE651" on page 62
- ⇒ "PN-HC861" on page 63
- ⇒ "PN-HC751" on page 64
- ⇒ "PN-HC651" on page 65

# Compatible Signal List

Resolution	Refresh rate (Hz)	HDMI video
640 x 480p	60	•
720 x 480i	60	•
720 x 480p	60	•
720 x 576i	50	•
720 x 576p	50	•
1280 x 720p	50	•
1280 x 720p	60	•
1920 x 1080i	50	•
	60	
1920 x 1080p	24	•
	25	
	30	
	50	
	60	
3840 x 2160p	24	•
	25	
	30	
	50	
	60	
4096 x 2160p	24	•
	25	
	30	
	50	
	60	

Resolution	Refresh rate (Hz)	VGA	HDMI PC
720 x 400	70	•	•
640 x 480	60	•	•
800 x 600	56	•	•
	60	•	•
1024 x 768	60	•	•
1280 x 720	60	•	•
1280 x 800	60	•	•
1280 x 960	60	•	•
1280 x 1024	60	•	•
	75	•	•
1400 x 1050	60 (RB*)	•	•
1440 x 900	60	•	•
1600 x 1200	60	•	•
1680 x 1050	60	•	•
1920 x 1080	60	•	•
3840 x 2160	30	—	•
	60	—	•
1366 x 768	60	—	•
1920 x 1440	60	—	•
2560 x 1600	60	—	•

\* RB: Reduced blanking signal

- NOTE:**
- Depending on the input signal's resolution, characters may look blurred or figures may be distorted.
  - Depending on the video card or driver used, the image may not be shown correctly.

# PN-HE751

Size (display size)		75"/1,892.74 mm diagonal		
Type of LCD		Active Matrix Color TFT LCD		
Viewable Size		1,649.664 x 927.936 mm		
Resolution		3,840 x 2,160		
Pixel Pitch		0.43 mm (H) x 0.43 mm (V)		
Color		Over 1073 million colors		
Brightness		600 cd/m <sup>2</sup> (Max.)		
Frequency	Horizontal	31 - 83 kHz (analog input) 15.625/15.734 kHz, 31 - 136 kHz (digital input)		
	Vertical	56 Hz, 60 Hz, 70 Hz, 75 Hz (analog input) 24 Hz, 30 Hz, 50 Hz, 60 Hz, 70 Hz, 75 Hz (digital input)		
Pixel Clock		13.5 MHz, 25 MHz - 156 MHz (analog input) 25 MHz - 600 MHz (digital input)		
Input Terminals	VGA (RGB)	Mini D-sub 15 pin	Analog RGB signal	
	HDMI	HDMI terminal	Digital YUV Digital RGB	
Audio Terminals	Audio input	Stereo Mini Jack 3.5 mm Ø	Analog audio signal	
		HDMI terminal	Digital audio signal	
	Audio output	Stereo Mini Jack 3.5 mm Ø	Analog audio signal	
		HDMI (ARC) terminal <sup>*1</sup>	Digital audio signal	
Speaker Output		Internal Speakers 10 W + 10 W (Stereo)		
Control Terminals	RS-232C	9 Pin D-sub x1		
	LAN	RJ-45 10BASE-T / 100BASE-TX		
USB Terminal	USB Type-A port	For media player/firmware update, DC 5 V / 500 mA (max)		
Operational Environment	Temperature	0 - 40 °C / 32 - 104 °F		
	Humidity	20 - 80 % (without condensation)		
Storage Environment	Temperature	-20 - 60 °C / -4 - 140 °F		
	Humidity	10 - 90 % (without condensation)		
Power Supply	Power input		AC 100 - 240 V 50/60 Hz	
	Input current		2.7 A	
	Consumption	Full operation		240 W (standard value)
		Networked standby mode		2.0 W or less <sup>*2</sup>
		Standby mode		0.5 W or less <sup>*2</sup>
Off mode		0.0 W		
Weight		Approx. 34 kg (75.0 lbs)		
Inclination Angle		±20°		

\*1 HDMI1 only.

\*2 When used with the default settings.

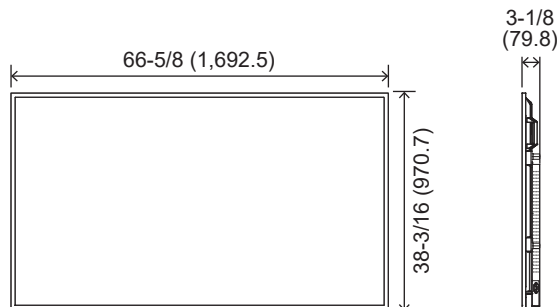

Unit: mm

As a part of our policy of continuous improvement, SHARP reserves the right to make design and specification changes for product improvement without prior notice. The performance specification figures indicated are nominal values of production units. There may be some deviations from these values in individual units.

# PN-HE651

Size (display size)		65"1,638.96 mm diagonal			
Type of LCD		Active Matrix Color TFT LCD			
Viewable Size		1,428.48 x 803.52 mm			
Resolution		3840 x 2160			
Pixel Pitch		0.372 mm (H) x 0.372 mm (V)			
Color		Over 1073 million colors			
Brightness		600 cd/m <sup>2</sup> (Max.)			
Frequency	Horizontal	31 - 83 kHz (analog input) 15.625/15.734 kHz, 31 - 136 kHz (digital input)			
	Vertical	56 Hz, 60 Hz, 70 Hz, 75 Hz (analog input) 24 Hz, 30 Hz, 50 Hz, 60 Hz, 70 Hz, 75 Hz (digital input)			
Pixel Clock		13.5 MHz, 25 MHz - 156 MHz (analog input) 25 MHz - 600 MHz (digital input)			
Input Terminals	VGA (RGB)	Mini D-sub 15 pin	Analog RGB signal	0.7 Vp-p/75 Ω	
	HDMI	HDMI terminal	Digital YUV Digital RGB	HDMI, HDCP2.2, Compatible with HDMI-CEC	
Audio Terminals	Audio input	Stereo Mini Jack 3.5 mm Ø	Analog audio signal	Stereo L/R 0.5 Vrms	
		HDMI terminal	Digital audio signal	PCM 2 ch 32, 44.1, 48 kHz (16/20/24 bits)	
	Audio output	Stereo Mini Jack 3.5 mm Ø	Analog audio signal	The output sound varies depending on the input mode. : Stereo L/R 0.1 Vrms	
		HDMI (ARC) terminal <sup>*1</sup>	Digital audio signal	PCM 2 ch 32, 44.1, 48 kHz (16/20/24 bits)	
Speaker Output		Internal Speakers 10 W + 10 W (Stereo)			
Control Terminals	RS-232C	9 Pin D-sub x1			
	LAN	RJ-45 10BASE-T / 100BASE-TX			
USB Terminal	USB Type-A port		For media player/firmware update, DC 5 V / 500 mA (max)		
Operational Environment	Temperature	0 - 40 °C / 32 - 104 °F			
	Humidity	20 - 80 % (without condensation)			
Storage Environment	Temperature	-20 - 60 °C / -4 - 140 °F			
	Humidity	10 - 90 % (without condensation)			
Power Supply	Power input		AC 100 - 240 V 50/60 Hz		
	Input current		2.2 A		
	Consumption	Full operation		190 W (standard value)	
		Networked standby mode		2.0 W or less <sup>*2</sup>	
		Standby mode		0.5 W or less <sup>*2</sup>	
Off mode		0.0 W			
Weight		Approx. 28 kg (61.8 lbs)			
Inclination Angle		±20°			

Dimensions

\*1 HDMI1 only.  
\*2 When used with the default settings.

Unit: mm

As a part of our policy of continuous improvement, SHARP reserves the right to make design and specification changes for product improvement without prior notice. The performance specification figures indicated are nominal values of production units. There may be some deviations from these values in individual units.

# PN-HC861

Size (display size)		86" / 2,174.27 mm diagonal		
Type of LCD		Active Matrix Color TFT LCD		
Viewable Size		1,895.04 x 1,065.96 mm		
Resolution		3840 x 2160		
Pixel Pitch		0.4935 mm (H) x 0.4935 mm (V)		
Color		Over 1073 million colors		
Brightness		450 cd/m <sup>2</sup> (Max.)		
Frequency	Horizontal	31 - 83 kHz (analog input) 15.625/15.734 kHz, 31 - 136 kHz (digital input)		
	Vertical	56 Hz, 60 Hz, 70 Hz, 75 Hz (analog input) 24 Hz, 30 Hz, 50 Hz, 60 Hz, 70 Hz, 75 Hz (digital input)		
Pixel Clock		13.5 MHz, 25 MHz - 156 MHz (analog input) 25 MHz - 600 MHz (digital input)		
Input Terminals	VGA (RGB)	Mini D-sub 15 pin	Analog RGB signal	
	HDMI	HDMI terminal	Digital YUV Digital RGB	
Audio Terminals	Audio input	Stereo Mini Jack 3.5 mm Ø	Analog audio signal	
		HDMI terminal	Digital audio signal	
	Audio output	Stereo Mini Jack 3.5 mm Ø	Analog audio signal	
		HDMI (ARC) terminal <sup>*1</sup>	Digital audio signal	
Speaker Output		Internal Speakers 10 W + 10 W (Stereo)		
Control Terminals	RS-232C	9 Pin D-sub x1		
	LAN	RJ-45 10BASE-T / 100BASE-TX		
USB Terminal	USB Type-A port		For media player/firmware update, DC 5 V / 500 mA (max)	
Operational Environment	Temperature	0 - 40 °C / 32 - 104 °F		
	Humidity	20 - 80 % (without condensation)		
Storage Environment	Temperature	-20 - 60 °C / -4 - 140 °F		
	Humidity	10 - 90 % (without condensation)		
Power Supply	Power input		AC 100 - 240 V 50/60 Hz	
	Input current		3.9 A	
	Consumption	Full operation		350 W (standard value)
		Networked standby mode		2.0 W or less <sup>*2</sup>
		Standby mode		0.5 W or less <sup>*2</sup>
Off mode		0.0 W		
Weight		Approx. 44 kg (97.1 lbs)		
Inclination Angle		±20°		

\*1 HDMI1 only.

\*2 When used with the default settings.

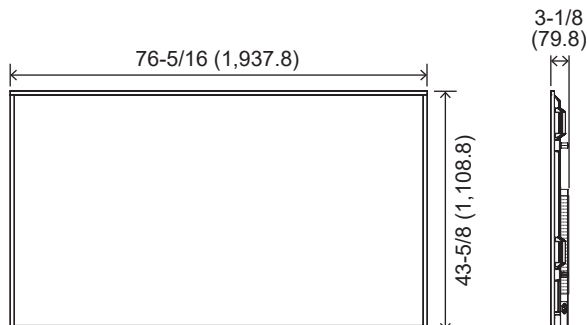

Unit: mm

As a part of our policy of continuous improvement, SHARP reserves the right to make design and specification changes for product improvement without prior notice. The performance specification figures indicated are nominal values of production units. There may be some deviations from these values in individual units.

# PN-HC751

Size (display size)		75"/1,892.74 mm diagonal		
Type of LCD		Active Matrix Color TFT LCD		
Viewable Size		1,649.664 x 927.936 mm		
Resolution		3840 x 2160		
Pixel Pitch		0.43 mm (H) x 0.43 mm (V)		
Color		Over 1073 million colors		
Brightness		450 cd/m <sup>2</sup> (Max.)		
Frequency	Horizontal	31 - 83 kHz (analog input) 15.625/15.734 kHz, 31 - 136 kHz (digital input)		
	Vertical	56 Hz, 60 Hz, 70 Hz, 75 Hz (analog input) 24 Hz, 30 Hz, 50 Hz, 60 Hz, 70 Hz, 75 Hz (digital input)		
Pixel Clock		13.5 MHz, 25 MHz - 156 MHz (analog input) 25 MHz - 600 MHz (digital input)		
Input Terminals	VGA (RGB)	Mini D-sub 15 pin	Analog RGB signal	
	HDMI	HDMI terminal	Digital YUV Digital RGB	
Audio Terminals	Audio input	Stereo Mini Jack 3.5 mm Ø	Analog audio signal	
		HDMI terminal	Digital audio signal	
	Audio output	Stereo Mini Jack 3.5 mm Ø	Analog audio signal	
		HDMI (ARC) terminal <sup>*1</sup>	Digital audio signal	
Speaker Output		Internal Speakers 10 W + 10 W (Stereo)		
Control Terminals	RS-232C	9 Pin D-sub x1		
	LAN	RJ-45 10BASE-T / 100BASE-TX		
USB Terminal	USB Type-A port	For media player/firmware update, DC 5 V / 500 mA (max)		
Operational Environment	Temperature	0 - 40 °C / 32 - 104 °F		
	Humidity	20 - 80 % (without condensation)		
Storage Environment	Temperature	-20 - 60 °C / -4 - 140 °F		
	Humidity	10 - 90 % (without condensation)		
Power Supply	Power input		AC 100 - 240 V 50/60 Hz	
	Input current		2.7 A	
	Consumption	Full operation		240 W (standard value)
		Networked standby mode		2.0 W or less <sup>*2</sup>
		Standby mode		0.5 W or less <sup>*2</sup>
Off mode		0.0 W		
Weight		Approx. 34 kg (75.0 lbs)		
Inclination Angle		±20°		

\*1 HDMI1 only.

\*2 When used with the default settings.

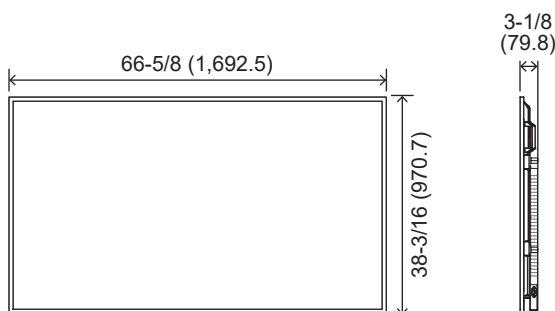

Unit: mm

As a part of our policy of continuous improvement, SHARP reserves the right to make design and specification changes for product improvement without prior notice. The performance specification figures indicated are nominal values of production units. There may be some deviations from these values in individual units.

# PN-HC651

Size (display size)		65"1,638.96 mm diagonal		
Type of LCD		Active Matrix Color TFT LCD		
Viewable Size		1428.48 x 803.52 mm		
Resolution		3840 x 2160		
Pixel Pitch		0.372 mm (H) x 0.372 mm (V)		
Color		Over 1073 million colors		
Brightness		450 cd/m <sup>2</sup> (Max.)		
Frequency	Horizontal	31 - 83 kHz (analog input) 15.625/15.734 kHz, 31 - 136 kHz (digital input)		
	Vertical	56 Hz, 60 Hz, 70 Hz, 75 Hz (analog input) 24 Hz, 30 Hz, 50 Hz, 60 Hz, 70 Hz, 75 Hz (digital input)		
Pixel Clock		13.5 MHz, 25 MHz - 156 MHz (analog input) 25 MHz - 600 MHz (digital input)		
Input Terminals	VGA (RGB)	Mini D-sub 15 pin	Analog RGB signal	
	HDMI	HDMI terminal	Digital YUV Digital RGB	
Audio Terminals	Audio input	Stereo Mini Jack 3.5 mm Ø	Analog audio signal	
		HDMI terminal	Digital audio signal	
	Audio output	Stereo Mini Jack 3.5 mm Ø	Analog audio signal	
		HDMI (ARC) terminal <sup>*1</sup>	Digital audio signal	
Speaker Output		Internal Speakers 10 W + 10 W (Stereo)		
Control Terminals	RS-232C	9 Pin D-sub x1		
	LAN	RJ-45 10BASE-T / 100BASE-TX		
USB Terminal	USB Type-A port	For media player/firmware update, DC 5 V / 500 mA (max)		
Operational Environment	Temperature	0 - 40 °C / 32 - 104 °F		
	Humidity	20 - 80 % (without condensation)		
Storage Environment	Temperature	-20 - 60 °C / -4 - 140 °F		
	Humidity	10 - 90 % (without condensation)		
Power Supply	Power input		AC 100 - 240 V 50/60 Hz	
	Input current		2.2 A	
	Consumption	Full operation		190 W (standard value)
		Networked standby mode		2.0 W or less <sup>*2</sup>
		Standby mode		0.5 W or less <sup>*2</sup>
Off mode		0.0 W		
Weight		Approx. 28 kg (61.8 lbs)		
Inclination Angle		±20°		
Dimensions				
<p>*1 HDMI1 only.</p> <p>*2 When used with the default settings.</p> <div style="text-align: center;"> <p style="text-align: right;">Unit: mm</p> </div>				

As a part of our policy of continuous improvement, SHARP reserves the right to make design and specification changes for product improvement without prior notice. The performance specification figures indicated are nominal values of production units. There may be some deviations from these values in individual units.

# Appendix A Trademark and Software License

Microsoft and Windows are trademarks of the Microsoft group of companies.

The terms HDMI, HDMI High-Definition Multimedia Interface, HDMI Trade Dress and the HDMI Logos are trademarks or registered trademarks of HDMI Licensing Administrator, Inc.

Blu-ray is a trademark of Blu-ray Disc Association.

Intel is a trademark of Intel Corporation or its subsidiaries.

Google is a trademark or registered trademarks of Google LLC.

All other brand and product names are trademarks or registered trademarks of their respective holders.



---

---

## [Notice] About the MPEG-4 AVC, MPEG-4 Visual license included in this product

---

---

### 1. MPEG AVC

THIS PRODUCT IS LICENSED UNDER THE AVC PATENT PORTFOLIO LICENSE FOR THE PERSONAL USE OF A CONSUMER OR OTHER USES IN WHICH IT DOES NOT RECEIVE REMUNERATION TO (i) ENCODE VIDEO IN COMPLIANCE WITH THE AVC STANDARD ("AVC VIDEO") AND/OR (ii) DECODE AVC VIDEO THAT WAS ENCODED BY A CONSUMER ENGAGED IN A PERSONAL ACTIVITY AND/OR WAS OBTAINED FROM A VIDEO PROVIDER LICENSED TO PROVIDE AVC VIDEO. NO LICENSE IS GRANTED OR SHALL BE IMPLIED FOR ANY OTHER USE. ADDITIONAL INFORMATION MAY BE OBTAINED FROM MPEG LA, L.L.C. SEE [HTTP://WWW.MPEGLA.COM](http://www.mpegla.com)

### 2. MPEG-4 Visual

THIS PRODUCT IS LICENSED UNDER THE MPEG-4 VISUAL PATENT PORTFOLIO LICENSE FOR THE PERSONAL AND NON-COMMERCIAL USE OF A CONSUMER FOR (i) ENCODING VIDEO IN COMPLIANCE WITH THE MPEG-4 VISUAL STANDARD ("MPEG-4 VIDEO") AND/OR (ii) DECODING MPEG-4 VIDEO THAT WAS ENCODED BY A CONSUMER ENGAGED IN A PERSONAL AND NONCOMMERCIAL ACTIVITY AND/OR WAS OBTAINED FROM A VIDEO PROVIDER LICENSED BY MPEG LA TO PROVIDE MPEG-4 VIDEO. NO LICENSE IS GRANTED OR SHALL BE IMPLIED FOR ANY OTHER USE. ADDITIONAL INFORMATION INCLUDING THAT RELATING TO PROMOTIONAL, INTERNAL AND COMMERCIAL USES AND LICENSING MAY BE OBTAINED FROM MPEG LA, LLC. SEE [HTTP://WWW.MPEGLA.COM](http://www.mpegla.com).

# Appendix B OSD Controls List

## **This Chapter Includes:**

- ⇒ "Picture Settings" on page 68
- ⇒ "Audio Settings" on page 70
- ⇒ "Setup" on page 71
- ⇒ "Control Settings" on page 73
- ⇒ "Media Player" on page 74
- ⇒ "Schedule" on page 75

# Picture Settings

Picture	
Picture Mode	Provides pre-configured video settings suitable for various environments where this device may be used, or customize settings to your preference.
HDR Video	Video setting for the HDR format. (Can be selected only when an HDR signal is input.)
Dynamic	High-contrast video setting.
Standard	Standard setting.
Conferencing	Video setting suited for video conferences.
HighBright	Maximum backlight brightness with higher color temperature for brighter ambient environments.
Custom	Customizable settings.
Advanced	Menu used to adjust detailed video settings.
Aspect Ratio	Select the aspect ratio of the screen image. For more information, see “Setting the Aspect Ratio” in this manual.
Normal	Maximizes the size without changing the aspect ratio.
1:1	Shows the image in a 1 by 1 pixel format. (If the input resolution is higher than the recommended resolution, the image will be scaled down to fit the screen).
Full	Fills the entire screen even if the aspect ratio needs to be changed.
Zoom	Fills the entire screen without changing the aspect ratio. <b>NOTE:</b> The areas of the image that are outside of the active screen area are not shown.
Overscan	Selects the image display area.
Auto	The image display area is set automatically.
On	Approximately 95 % of the image will be shown on the screen.
Off	The whole image is displayed within the screen area. This setting may cause noise at the edges of the screen depending on the signal. <b>NOTE:</b> When you use a computer with an HDMI output, set it to [OFF].
Color Temperature	Adjusts the color temperature of the entire screen. A low color temperature will result in a reddish screen. A high color temperature will make the screen bluish. If a temperature needs further adjustment, the individual R/G/B/ levels of the white point can be adjusted.
Cool	High color temperature setting. The screen will be bluish.
Normal	Intermediate setting.
Warm	Low color temperature setting. The screen will be reddish.
Native	Turns the color temperature adjustment off and displays the image with the panel characteristics.
Custom	Customizable settings.
Noise Reduction	Reduces the image noise.
Adaptive Contrast	Adjusts automatically the contrast according to the image. If [High] is set, the image is shown clearly but the brightness variation may appear not natural.

**NOTE:** When values except [Aspect Ratio] and [Overscan] in [Picture] Menu is adjusted manually, [Picture Mode] becomes [Custom].

Picture		
Gamma	Adjusts the brightness of gray and other intermediate colors. (SDR)	
	Native	Gamma correction is handled by the LCD panel.
	2.2	Typical monitor gamma for use with a computer.
	2.4	Typical gamma settings for use with video devices, such as DVDs and Blu-rays.
	Color Enhance	Changes the colors of the image and the saturation to create a more colorful image.
HDR Mode	When the monitor detects an HDR signal, you can select preferred gamma correction.	
Backlight / Brightness	Adjusts the brightness of the image using the backlight. Press the ◀ and ▶ the buttons to adjust the brightness. In general, use this function to adjust the brightness.	
Contrast	Adjusts the contrast. Press the ◀ and ▶ the buttons to adjust the contrast.	
Black Level	Set the black level of the screen. When the setting is too low to show, the OSD characters are changed to green.	
Sharpness	Adjusts the sharpness of the image. Press the ▶ button to sharpen the image, or the ◀ button to soften it.	
Color	Adjusts the color density of the screen. Press the ▶ button to increase the density, or the ◀ button to decrease it.	
Tint	Adjusts the tint of the image between R0-R50 and G0-G50.	
Reset Picture Settings	Returns all settings in the Picture Settings to their default values.	

# Audio Settings

Audio	
Sound Mode	Set pre-configured audio settings suitable for various environments where the monitor may be used, or customize settings to your preference.
Standard	Standard sound setting.
Music	Optimized settings for music playback or audio in conference rooms.
Movie	Surround sound for clarity in retail stores and other signage applications.
Custom	Customizable settings.
Balance	Press the ► button to move the audio signal to the right. Press the ◀ button to move the audio signal to the left.
Surround	Artificially produces surround sound audio.
Internal Speakers	Configures the settings for the internal speakers output. This setting is enabled when Disable is selected for Audio receiver.
Auto	The sound is not output from the internal speakers when a cable is connected to the AUDIO OUT terminal.
Off	Sound is not output from the internal speakers.
On	Sound is always output from the internal speakers.
Audio Input	Selects whether to use the audio signal of the Audio In terminal when the audio signal is not included in the HDMI signal (DVI signals, etc.). <b>HDMI:</b> The HDMI terminal is used. <b>Audio in:</b> The AUDIO IN terminal is used.
Audio Delay	Adjusts the delay time until the audio is output.
Reset Audio Settings	Returns all settings in the Audio Settings to their default values.

# Setup

Setup	
OSD Settings	
Language	Select the language used in the OSD.
Transparency	Set the transparency level of the OSD menu between 30%, 50%, 70% and Off. The higher the percentage, the more transparent is the OSD menu.
Information OSD	Displays or hides the Information OSD. Information OSD contains the messages that are displayed on the screen when the input is switched or when the state of the input signal changes.
Power save settings	
Energy Mode	Select a mode between Home, Retail, and Office. For more information, see “Energy Mode” page 30.
Time Setting	Sets the time until the monitor enters the Power Save mode. When the set time has elapsed after the input signal has been lost, the Power Save function is activated.
Auto Power Down	When turned On, the monitor turns automatically off after 4 hours without any operation.
Auto Input Change	When there are several inputs, this function switches automatically to the terminal to which a signal is input. Press the INFORMATION button of the remote control to display the selected input terminal on INFORMATION1. <b>NOTE:</b> This setting and USB Demo Mode cannot be used simultaneously.
Off	The input terminal is changed manually.
On	If the signal is lost in the input terminal being displayed, the monitor searches automatically another terminal with an input signal and switches to it. The display does not change if a new signal is input into a terminal different from the terminal currently being displayed.
Custom	The input terminals included in the search performed by the monitor can be selected. <b>NOTE:</b> If [Custom] is selected, the monitor will not switch to an input signal not set in [Search terminal].
HDMI Settings	
CEC	This function makes it possible to control a device supporting HDMI CEC connected to the HDMI terminal. When set to On, HDMI CEC is enabled.
EDID	Sets the HDMI mode. <b>Mode 0:</b> Max resolution is 1920 x 1080 (60 Hz). <b>Mode 1:</b> Max resolution is 4096 x 2160 (30 Hz). <b>Mode 2:</b> Max resolution is 4096 x 2160 (60 Hz), HDCP 2.2, or HDR.
Video Range	Adjust the gradation range to be shown according to the video signal to improve the whiteout and blackout of the image.
HPD Delay	This function makes it possible to control the time until the video from the HDMI terminal is displayed. When set to Off, the time until the video is output can be reduced but the video may not be output depending on the device. In such a case, set [HPD Delay] to On.

Setup	
VGA Options	Enabled when a VGA signal is input.
Auto Adjust	Automatically adjusts settings such as the image position.
H.Position	Adjusts the horizontal position of the screen. Press the ► button to move the screen to the right or the ◀ button to move it to the left.
V.Position	Adjusts the vertical position of the screen. Press the ► button to move the screen to the top or the ◀ button to move it to the bottom.
Clock	Adjust this setting when vertical lines appear on the screen or when the size differs at the right and left of the screen.
Phase	Adjust this setting when noise appears in the horizontal direction, when the characters are blurred, or when the contours are not sharp.
H.Resolution	The video can be enlarged/reduced in the horizontal direction using this function only when [Standard] is selected in [Aspect Ratio]. <b>NOTE:</b> This function may not operate depending on the input signal.
V.Resolution	The video can be enlarged/reduced in the vertical direction using this function only when [Standard] is selected in [Aspect Ratio]. <b>NOTE:</b> This function may not operate depending on the input signal.
Reset VGA Options	Resets the VGA Options settings to their default values.
Other settings	
Input Labels	Renames the input terminal currently being displayed. Letters (A-Z), numbers (0-9), and some symbols can be used.
Key Lock Settings	Prevents the monitor from being controlled using the buttons on the monitor control panel. <b>Off:</b> All buttons operate normally. <b>Mode 1:</b> Only the power button and the input mode switching function operate. <b>Mode 2:</b> All buttons are locked. (Only the power button can be used during standby state.)
IR Lock Settings	Prevents the monitor from being controlled using the remote control. <b>Off:</b> All buttons operate normally. <b>Mode 1:</b> Only the POWER and the INPUT buttons operate. <b>Mode 2:</b> All buttons are locked. (Only the POWER button can be used during standby state.)
LED Indicator	Set it to Off to turn off the power indicator when the monitor is turned on (normally lit green).
Mute Settings	You can change the effect of the MUTE button of the remote control. <b>Audio:</b> Mutes only the audio files. <b>Video:</b> Mutes only the video files. <b>Audio &amp; Video:</b> Mutes the audio and the video files.
Rotate 180°	You can rotate the video 180 degrees.
Thermal Management	You can select the vertical or horizontal installation direction in the sensor settings. The monitor is equipped with thermal sensors and displays a warning when the ambient temperature exceeds the operation guaranteed temperature. If a warning is displayed, turn the monitor off since using the monitor in such environment may cause a malfunction. <b>Warning Message:</b> A temperature warning is displayed on the screen when the internal temperature has exceeded the operation guaranteed temperature. <b>Shutdown:</b> The monitor turns off automatically when the internal temperature has exceeded the operation guaranteed temperature.
Signal Information	Displays the information regarding the input signal.
Monitor Information	Displays the information regarding the monitor.
Factory Reset	All settings except network are returned to factory default.

# Control Settings

Control Settings	
Control Interface	<b>NOTE:</b> Only one method, LAN or RS-232, can be used at the same time. Control Interface is available after IP address is obtained automatically.
LAN	Sets network (LAN) control.
RS-232C	Sets RS-232C control.
Network Settings	Configures the network settings of the monitor.
DHCP	<b>On:</b> Obtains the network settings from the DHCP server on the network. <b>Off:</b> Sets fixed networks settings. <b>Manual DNS:</b> Obtain the network settings from the DHCP server on the network but the DNS is set manually.
IP ADDRESS	Set the IP address of the monitor when [DHCP] is set to [Off].
SUBNET MASK	Set the subnet mask for the network to which the monitor is connected when [Off] is selected for [DHCP].
DEFAULT GATEWAY	Set the default gateway for the network to which the monitor is connected when [Off] is selected for [DHCP].
DNS PRIMARY	Enter the IP address of the primary DNS server of the network connected to the monitor. <b>NOTE:</b> Enter [0.0.0.0] to delete the setting.
DNS SECONDARY	Enter the IP address of the secondary DNS server of the network connected to the monitor. <b>NOTE:</b> Enter [0.0.0.0] to delete the setting.
MAC ADDRESS	Shows the monitor's MAC ADDRESS. This cannot be changed.
SAVE	Saves the settings.
Reset Network Settings	Returns the network settings to their default values.

# Media Player

Media Player	
USB Demo Mode	<p>Photos (still pictures), music and video files saved in the “DEMO” folder in the USB storage device can be played automatically.            Select the files (photos, music or video files) to play in the USB Demo Mode. Different types of files cannot be played automatically at the same time.</p> <p><b>NOTE:</b>  <b>Enabling USB Demo Mode</b>            To enable the USB Demo Mode, [Energy Mode] in the [Setup] menu must be set to [Retail].            To enable the USB Demo Mode, [Auto Input Change] in the [Setup] menu must be set to [Off].</p> <p><b>NOTE:</b>  <b>Starting USB Demo Mode</b>            The playback of the files starts automatically under the following conditions.</p> <ul style="list-style-type: none"> <li>• The USB Demo Mode has been enabled.</li> <li>• A folder named “DEMO” exists in the USB storage device.</li> <li>• No signal is being input in a terminal other than the USB port.</li> <li>• There was no user operation for 10 seconds or more.</li> </ul> <p><b>NOTE:</b>  <b>Memo</b></p> <ul style="list-style-type: none"> <li>• The POWER, VOLUME, and MUTE buttons of the remote control operate normally. If other buttons are pressed, the playback stops and the input returns to the terminal used previously.</li> <li>• The playback is also stopped if the USB storage device is removed.</li> <li>• If the monitor is turned off during playback in USB Demo Mode, the next time the monitor is turned on, playback will start automatically if the USB storage device is still connected.</li> <li>• This setting and Auto Input Change cannot be used simultaneously.</li> </ul>
UnPlug USB Device	Select [Execute] before removing the USB device.
Caution Window	Sets whether to display a caution window (On) or not (Off) when a file with a format or a codec not supported by the monitor is played.

# Schedule

---

Schedule	
Sleep Timer	<p>Sets the time until the monitor turns off automatically. <b>Off, 10 minutes, 15 minutes, 30 minutes, 60 minutes, 90 minutes, 120 minutes, 180 minutes, 240 minutes</b> can be selected.</p> <p><b>NOTE:</b></p> <ul style="list-style-type: none"><li>• Sleep Timer is available when Energy Mode is [Home] or [Office].</li></ul>
Current Time settings	<p>Sets the current time.</p> <p><b>NOTE:</b></p> <ul style="list-style-type: none"><li>• If the monitor remains for two weeks or more with the power cord unplugged, the clock will not show the correct time. In this case, set the [Current Time settings] again.</li><li>• Check regularly that the set date and time are correct.</li></ul>
Power settings	<p><b>Power On:</b> Sets the time when the monitor will turn on. <b>Power Off:</b> Sets the time when the monitor will turn off.</p>

# Appendix C Others

## **This Chapter Includes:**

- ⇒ "RS-232C command table" on page 77
- ⇒ "Intellectual Property Rights and Other Matters" on page 79

# RS-232C command table

## How to read the command table

Command: Command field

Direction: W When the "Parameter" is set in the parameter field, the command functions as described under "Control/Response Contents".

R The returned value indicated under "Reply" can be obtained by setting "???" or "???" in the parameter field.

Parameter: Parameter field

Reply: Response

\* : "●" : Indicates a command which can be used in standby state, input signal waiting state or when the power is on.

"-" : Indicates a command which can be used when the power is on.

## Power control/Input mode selection

Function	Command	Direction	Parameter	Reply	Control/Response contents	*
POWER CONTROL	POWR	W	0		Switches to standby state.	●
			1		Returns from standby state.	
		R	0		Standby state	
			1		Normal mode	
			2		Input signal waiting state	
INPUT MODE SELECTION	INPS	WR	0		Toggle change for input mode.	-
			2	2	VGA (RGB)	
			10	10	HDMI1	
			11	11	Media Player	
			13	13	HDMI2	
			18	18	HDMI3	

## PICTURE menu

Function	Command	Direction	Parameter	Reply	Control/Response contents	*
BRIGHT	VLMP	WR	0-100	0-100		-
SIZE (Changing aspect ratio)	WIDE	WR	1	1	Full	
			2	2	Normal	
			3	3	1:1	
			4	4	Zoom	
COLOR MODE	BMOD	WR	0	0	Standard	
			2	2	Dynamic	
			4	4	HighBright	
			5	5	Conferencing	
			8	8	Custom	
WHITE BALANCE	CTMP	WR	0	0	Native	
			8	8	Warm	
			17	17	Normal	
			22	22	Cool	
			99	99	Custom	
R-CONTRAST	CRTR	WR	0-255	0-255	The contrast value when the Color Temperature is set to Custom. Error if the Color Temperature is not set to custom.	
G-CONTRAST	CRTG	WR	0-255	0-255		
B-CONTRAST	CRTB	WR	0-255	0-255		

## SETUP menu

Function	Command	Direction	Parameter	Reply	Control/Response contents	*
TIME SETTING	TIME	WR	AABB	AABB	AA: Hour, BB: Minute	
User name	USER	WR	XXXXXXXX	XXXXXXXX	User name when controlling the monitor via RS-232C commands with LAN. USER command is enabled when Control Interface is set to LAN.	
Password	PASS	WR	XXXXXXXX	XXXXXXXX	Password when controlling the monitor via RS-232C commands with LAN. PASS command is enabled when Control Interface is set to LAN.	
SENSOR SETTING	STDR	WR	0-1	0-1	0: LANDSCAPE, 1: PORTRAIT	
Model	INF1	R		Value		-
Serial no.	SRNO	R		Value		
Key Lock Settings	ALCM	WR	0-2	0-2	0: Off, 1: All buttons are locked, 2: Only the power button and the input mode switching function operate	
IR Lock Settings	ALCR	WR	0-1, 3	0-1, 3	0: Off, 1: All buttons are locked (Mode 2), 3: Only the POWER and the INPUT buttons operate (Mode 1)	
ALL RESET	RSET	W	0		Initialization	

## Others

Function	Command	Direction	Parameter	Reply	Control/Response contents	*
VOLUME	VOLM	WR	0-100	0-100		
MUTE AUDIO	MUTE	WR	0-1	0-1	0: OFF, 1: ON	
Temperature sensor	DSTA	R	0	0	Internal temperature normal	-
			3	3	Internal temperature has exceeded the operation guaranteed temperature	
Temperature acquisition	ERRT	R		Value	Returns the temperature at the temperature sensors.	
Check the resolution	PXCK	R		Value	Returns current resolution.	

# Intellectual Property Rights and Other Matters

## Information on the software license for this product

### Software composition

The software included in this product is comprised of various software components whose individual copyrights are held by SHARP or by third parties.

This product makes use of freely distributed software and software components whose copyrights are held by third parties. These include software components covered by a GNU General Public License (hereafter GPL), a GNU Lesser General Public License (hereafter LGPL) and an Apache License.

### Obtaining source code

Some of the open source software licensors require the distributor to provide the source code with the executable software components. GPL and LGPL include similar requirements.

We are unable to answer any questions about the source code for the open source software. The source code for the software components whose copyrights are held by SHARP is not distributed.

### Acknowledgements

The following open source software components are included in this product:

Ethtool, ser2net, lua-cjson, libhttplib, glibc, libjson, lua, libbubox, uhttpd, netifd, Linux Kernel, fstools, ubox, zlib, util-linux, procd, usingn, luci-theme-boot-strap, luci-base, busybox, linux-firmware, libgpg-error, Noto Fonts

## Software copyrights

Ethtool v3.18  
Ethtool is available under the terms of the GNU Public License version 2.

ser2net 2.10.0-2  
GNU GENERAL PUBLIC LICENSE  
Version 2, June 1991

netifd 2015-12-16  
netifd - network interface daemon  
Copyright (C) 2012 Felix Fietkau <nbd@openwrt.org>

This program is free software; you can redistribute it and/or modify it under the terms of the GNU General Public License version 2 as published by the Free Software Foundation

This program is distributed in the hope that it will be useful, but WITHOUT ANY WARRANTY; without even the implied warranty of MERCHANTABILITY or FITNESS FOR A PARTICULAR PURPOSE. See the GNU General Public License for more details.

busybox 1.23.2  
BusyBox is distributed under version 2 of the General Public License (included in its entirety, below). Version 2 is the only version of this license which this version of BusyBox (or modified versions derived from this one) may be distributed under.

ubox 2015-11-22  
procd 2015-10-29.1  
Copyright (C) 2013 Felix Fietkau <nbd@openwrt.org>  
Copyright (C) 2013 John Crispin <blogic@openwrt.org>

This program is free software; you can redistribute it and/or modify it under the terms of the GNU Lesser General Public License version 2.1 as published by the Free Software Foundation

This program is distributed in the hope that it will be useful, but WITHOUT ANY WARRANTY; without even the implied warranty of MERCHANTABILITY or FITNESS FOR A PARTICULAR PURPOSE. See the GNU General Public License for more details.

fstools 2016-01-10  
\* Copyright (C) 2013 Felix Fietkau nbd@openwrt.org  
\* Copyright (C) 2013/2014 John Crispin <blogic@openwrt.org>

This program is free software; you can redistribute it and/or modify it under the terms of the GNU Lesser General Public License version 2.1 as published by the Free Software Foundation

This program is distributed in the hope that it will be useful, but WITHOUT ANY WARRANTY; without even the implied warranty of MERCHANTABILITY or FITNESS FOR A PARTICULAR PURPOSE. See the GNU General Public License for more details.

glibc  
GNU Lesser General Public License

kernel 3.18.109  
GNU General Public License version 2

usingn 2015-05-08  
usingn - tiny signify replacement

Copyright (C) 2015 Felix Fietkau <nbd@openwrt.org>

Permission to use, copy, modify, and/or distribute this software for any purpose with or without fee is hereby granted, provided that the above copyright notice and this permission notice appear in all copies.

THE SOFTWARE IS PROVIDED "AS IS" AND THE AUTHOR DISCLAIMS ALL WARRANTIES WITH REGARD TO THIS SOFTWARE INCLUDING ALL IMPLIED WARRANTIES OF MERCHANTABILITY AND FITNESS. IN NO EVENT SHALL THE AUTHOR BE LIABLE FOR ANY SPECIAL, DIRECT, INDIRECT, OR CONSEQUENTIAL DAMAGES OR ANY DAMAGES WHATSOEVER RESULTING FROM LOSS OF USE, DATA OR PROFITS, WHETHER IN AN ACTION OF CONTRACT, NEGLIGENCE OR OTHER TORTIOUS ACTION, ARISING OUT OF OR IN CONNECTION WITH THE USE OR PERFORMANCE OF THIS SOFTWARE.

luci-theme-bootstrap 2015-05-08  
LuCI Theme Bootstrap: Copyright 2012 Nut & Bolt Twitter Bootstrap: Copyright 2011 Twitter, Inc.  
Licensed under the Apache License, Version 2.0 (the "License");  
you may not use this file except in compliance with the License.  
You may obtain a copy of the License at

<http://www.apache.org/licenses/LICENSE-2.0>

Unless required by applicable law or agreed to in writing, software distributed under the License is distributed on an "AS IS" BASIS, WITHOUT WARRANTIES OR CONDITIONS OF ANY KIND, either express or implied.  
See the License for the specific language governing permissions and limitations under the License.

luci-base  
Copyright (C) 2008-2015 The LuCI Team <luci@lists.subsignal.org>  
Licensed under the Apache License, Version 2.0 (the "License");  
you may not use this file except in compliance with the License.  
You may obtain a copy of the License at

<http://www.apache.org/licenses/LICENSE-2.0>

Unless required by applicable law or agreed to in writing, software distributed under the License is distributed on an "AS IS" BASIS, WITHOUT WARRANTIES OR CONDITIONS OF ANY KIND, either express or implied.  
See the License for the specific language governing permissions and limitations under the License.

linux-firmware 2016-01-25  
Copyright (c) 2015, Qualcomm Atheros, Inc.  
All rights reserved.

Redistribution. Reproduction and redistribution in binary form, without modification, for use solely in conjunction with a Qualcomm Atheros, Inc. chipset, is permitted provided that the following conditions are met:

- Redistributions must reproduce the above copyright notice and the following disclaimer in the documentation and/or other materials provided with the distribution.
- Neither the name of Qualcomm Atheros, Inc. nor the names of its suppliers may be used to endorse or promote products derived from this Software without specific prior written permission.
- No reverse engineering, decompilation, or disassembly of this Software is permitted.

Limited patent license. Qualcomm Atheros, Inc. ("Licensor") grants you ("Licensee") a limited, worldwide, royalty-free, non-exclusive license under the Patents to make, have made, use, import, offer to sell and sell the Software. No hardware per se is licensed hereunder.

The term "Patents" as used in this agreement means only those patents or patent applications owned solely and exclusively by Licensor as of the date of Licensor's submission of the Software and any patents deriving priority (i.e., having a first effective filing date) therefrom. The term "Software" as used in this agreement means the firmware image submitted by Licensor, under the terms of this license, to [git://git.kernel.org/pub/scm/linux/kernel/git/firmware/linux-firmware.git](http://git.kernel.org/pub/scm/linux/kernel/git/firmware/linux-firmware.git).

Notwithstanding anything to the contrary herein, Licensor does not grant and Licensee does not receive, by virtue of this agreement or the Licensor's submission of any Software, any license or other rights under any patent or patent application owned by any affiliate of Licensor or any other entity (other than Licensor), whether expressly, impliedly, by virtue of estoppel or exhaustion, or otherwise.

DISCLAIMER. THIS SOFTWARE IS PROVIDED BY THE COPYRIGHT HOLDERS AND CONTRIBUTORS "AS IS" AND ANY EXPRESS OR IMPLIED WARRANTIES, INCLUDING, BUT NOT LIMITED TO, THE IMPLIED WARRANTIES OF MERCHANTABILITY AND FITNESS FOR A PARTICULAR PURPOSE ARE DISCLAIMED. IN NO EVENT SHALL THE COPYRIGHT OWNER OR CONTRIBUTORS BE LIABLE FOR ANY DIRECT, INDIRECT, INCIDENTAL, SPECIAL, EXEMPLARY, OR CONSEQUENTIAL DAMAGES (INCLUDING, BUT NOT LIMITED TO, PROCUREMENT OF SUBSTITUTE GOODS OR SERVICES; LOSS OF USE, DATA, OR PROFITS; OR BUSINESS INTERRUPTION) HOWEVER CAUSED AND ON ANY THEORY OF LIABILITY, WHETHER IN CONTRACT, STRICT LIABILITY, OR TORT (INCLUDING NEGLIGENCE OR OTHERWISE) ARISING IN ANY WAY OUT OF THE USE OF THIS SOFTWARE, EVEN IF ADVISED OF THE POSSIBILITY OF SUCH DAMAGE.

Lighttpd 1.4.45  
Copyright (c) 2004, Jan Kneschke, incremental  
All rights reserved.

Redistribution and use in source and binary forms, with or without modification, are permitted provided that the following conditions are met:

- Redistributions of source code must retain the above copyright notice, this list of conditions and the following disclaimer.
- Redistributions in binary form must reproduce the above copyright notice, this list of conditions and the following disclaimer in the documentation and/or other materials provided with the distribution.
- Neither the name of the 'incremental' nor the names of its contributors may be used to endorse or promote products derived from this software without specific prior written permission.

THIS SOFTWARE IS PROVIDED BY THE COPYRIGHT HOLDERS AND CONTRIBUTORS "AS IS" AND ANY EXPRESS OR IMPLIED WARRANTIES, INCLUDING, BUT NOT LIMITED TO, THE IMPLIED WARRANTIES OF MERCHANTABILITY AND FITNESS FOR A PARTICULAR PURPOSE ARE DISCLAIMED. IN NO EVENT SHALL THE COPYRIGHT OWNER OR CONTRIBUTORS BE LIABLE FOR ANY DIRECT, INDIRECT, INCIDENTAL, SPECIAL, EXEMPLARY, OR CONSEQUENTIAL DAMAGES (INCLUDING, BUT NOT LIMITED TO, PROCUREMENT OF SUBSTITUTE GOODS OR SERVICES; LOSS OF USE, DATA, OR PROFITS; OR BUSINESS INTERRUPTION) HOWEVER CAUSED AND ON ANY THEORY OF LIABILITY, WHETHER IN CONTRACT, STRICT LIABILITY, OR TORT (INCLUDING NEGLIGENCE OR OTHERWISE) ARISING IN ANY WAY OUT OF THE USE OF THIS SOFTWARE, EVEN IF ADVISED OF THE POSSIBILITY OF SUCH DAMAGE.

lua-cjson 2.1.0  
Copyright (c) 2010-2012 Mark Pulford <mark@kyne.com.au>

Permission is hereby granted, free of charge, to any person obtaining a copy of this software and associated documentation files (the "Software"), to deal in the Software without restriction, including without limitation the rights to use, copy, modify, merge, publish, distribute, sublicense, and/or sell copies of the Software, and to permit persons to whom the Software is furnished to do so, subject to the following conditions:

The above copyright notice and this permission notice shall be included in all copies or substantial portions of the Software.

THE SOFTWARE IS PROVIDED "AS IS", WITHOUT WARRANTY OF ANY KIND, EXPRESS OR IMPLIED, INCLUDING BUT NOT LIMITED TO THE WARRANTIES OF MERCHANTABILITY, FITNESS FOR A PARTICULAR PURPOSE AND NONINFRINGEMENT. IN NO EVENT SHALL THE AUTHORS OR COPYRIGHT HOLDERS BE LIABLE FOR ANY CLAIM, DAMAGES OR OTHER LIABILITY, WHETHER IN AN ACTION OF CONTRACT, TORT OR OTHERWISE, ARISING FROM, OUT OF OR IN CONNECTION WITH THE SOFTWARE OR THE USE OR OTHER DEALINGS IN THE SOFTWARE.

libjson-c 0.12  
Copyright (c) 2009-2012 Eric Haszlkiewicz

Permission is hereby granted, free of charge, to any person obtaining a copy of this software and associated documentation files (the "Software"), to deal in the Software without restriction, including without limitation the rights to use, copy, modify, merge, publish, distribute, sublicense, and/or sell copies of the Software, and to permit persons to whom the Software is furnished to do so, subject to the following conditions:

The above copyright notice and this permission notice shall be included in all copies or substantial portions of the Software.

THE SOFTWARE IS PROVIDED "AS IS", WITHOUT WARRANTY OF ANY KIND, EXPRESS OR IMPLIED, INCLUDING BUT NOT LIMITED TO THE WARRANTIES OF MERCHANTABILITY, FITNESS FOR A PARTICULAR PURPOSE AND NONINFRINGEMENT. IN NO EVENT SHALL THE AUTHORS OR COPYRIGHT HOLDERS BE LIABLE FOR ANY CLAIM, DAMAGES OR OTHER LIABILITY, WHETHER IN AN ACTION OF CONTRACT, TORT OR OTHERWISE, ARISING FROM, OUT OF OR IN CONNECTION WITH THE SOFTWARE OR THE USE OR OTHER DEALINGS IN THE SOFTWARE.

Lua 5.1.5  
Copyright (C) 1994-2012 Lua.org, PUC-Rio.

Permission is hereby granted, free of charge, to any person obtaining a copy of this software and associated documentation files (the "Software"), to deal in the Software without restriction, including without limitation the rights to use, copy, modify, merge, publish, distribute, sublicense, and/or sell copies of the Software, and to permit persons to whom the Software is furnished to do so, subject to the following conditions:

The above copyright notice and this permission notice shall be included in all copies or substantial portions of the Software.

THE SOFTWARE IS PROVIDED "AS IS", WITHOUT WARRANTY OF ANY KIND, EXPRESS OR IMPLIED, INCLUDING BUT NOT LIMITED TO THE WARRANTIES OF MERCHANTABILITY, FITNESS FOR A PARTICULAR PURPOSE AND NONINFRINGEMENT. IN NO EVENT SHALL THE AUTHORS OR COPYRIGHT HOLDERS BE LIABLE FOR ANY CLAIM, DAMAGES OR OTHER LIABILITY, WHETHER IN AN ACTION OF CONTRACT, TORT OR OTHERWISE, ARISING FROM, OUT OF OR IN CONNECTION WITH THE SOFTWARE OR THE USE OR OTHER DEALINGS IN THE SOFTWARE.

Libubox 2015-11-08  
Copyright (c) 2016, yubo  
All rights reserved.

Redistribution and use in source and binary forms, with or without modification, are permitted provided that the following conditions are met:

- \* Redistributions of source code must retain the above copyright notice, this list of conditions and the following disclaimer.
- \* Redistributions in binary form must reproduce the above copyright notice, this list of conditions and the following disclaimer in the documentation and/or other materials provided with the distribution.
- \* Neither the name of the author nor the names of its contributors may be used to endorse or promote products derived from this software without specific prior written permission.

THIS SOFTWARE IS PROVIDED BY THE COPYRIGHT HOLDERS AND CONTRIBUTORS "AS IS" AND ANY EXPRESS OR IMPLIED WARRANTIES, INCLUDING, BUT NOT LIMITED TO, THE IMPLIED WARRANTIES OF MERCHANTABILITY AND FITNESS FOR A PARTICULAR PURPOSE ARE DISCLAIMED. IN NO EVENT SHALL THE COPYRIGHT OWNER OR CONTRIBUTORS BE LIABLE FOR ANY DIRECT, INDIRECT, INCIDENTAL, SPECIAL, EXEMPLARY, OR CONSEQUENTIAL DAMAGES (INCLUDING, BUT NOT LIMITED TO, PROCUREMENT OF SUBSTITUTE GOODS OR SERVICES; LOSS OF USE, DATA, OR PROFITS; OR BUSINESS INTERRUPTION) HOWEVER CAUSED AND ON ANY THEORY OF LIABILITY, WHETHER IN CONTRACT, STRICT LIABILITY, OR TORT (INCLUDING NEGLIGENCE OR OTHERWISE) ARISING IN ANY WAY OUT OF THE USE OF THIS SOFTWARE, EVEN IF ADVISED OF THE POSSIBILITY OF SUCH DAMAGE.

uhttpd 2015-11-08  
uhttpd - Tiny single-threaded httpd

Copyright (C) 2010-2013 Jo-Philipp Wich <xm@subsignal.org>  
Copyright (C) 2013 Felix Fietkau <mbd@openwrt.org>

Permission to use, copy, modify, and/or distribute this software for any purpose with or without fee is hereby granted, provided that the above copyright notice and this permission notice appear in all copies.

THE SOFTWARE IS PROVIDED "AS IS" AND THE AUTHOR DISCLAIMS ALL WARRANTIES WITH REGARD TO THIS SOFTWARE INCLUDING ALL IMPLIED WARRANTIES OF MERCHANTABILITY AND FITNESS. IN NO EVENT SHALL THE AUTHOR BE LIABLE FOR ANY SPECIAL, DIRECT, INDIRECT, OR CONSEQUENTIAL DAMAGES OR ANY DAMAGES WHATSOEVER RESULTING FROM LOSS OF USE, DATA OR PROFITS, WHETHER IN AN ACTION OF CONTRACT, NEGLIGENCE OR OTHER TORTIOUS ACTION, ARISING OUT OF OR IN CONNECTION WITH THE USE OR PERFORMANCE OF THIS SOFTWARE.

libcrypt

Libcrypt - The GNU Crypto Library  
-----  
Version 1.6

Copyright (C) 1989,1991-2012 Free Software Foundation, Inc.  
Copyright (C) 2012-2014 g10 Code GmbH  
Copyright (C) 2013-2014 Jussi Kivlinna

Libcrypt is free software. See the file AUTHORS for full copying notices, and LICENSES for notices about contributions that require these additional notices to be distributed.

License  
-----

The library is distributed under the terms of the GNU Lesser General Public License (LGPL); see the file COPYING.LIB for the actual terms. The helper programs (e.g. gcryptnd and getrandom) as well as the documentation are distributed under the terms of the GNU General Public License (GPL); see the file COPYING for the actual terms. The file LICENSES has notices about contributions that require these additional notices are distributed.

Additional license notices for Libgrypt.                    -\*- org -\*-

This file contains the copying permission notices for various files in the Libgrypt distribution which are not covered by the GNU Lesser General Public License (LGPL) or the GNU General Public License (GPL).

These notices all require that a copy of the notice be included in the accompanying documentation and be distributed with binary distributions of the code, so be sure to include this file along with any binary distributions derived from the GNU C Library.

\* BSD\_3Clause

For files:  
- cipher/sha256-ssse3-amd64.S  
- cipher/sha512-avx-amd64.S  
- cipher/sha512-avx2-bmi2-amd64.S  
- cipher/sha512-ssse3-amd64.S

##+begin\_quote  
Copyright (c) 2012, Intel Corporation

All rights reserved.

Redistribution and use in source and binary forms, with or without modification, are permitted provided that the following conditions are met:

- \* Redistributions of source code must retain the above copyright notice, this list of conditions and the following disclaimer.
- \* Redistributions in binary form must reproduce the above copyright notice, this list of conditions and the following disclaimer in the documentation and/or other materials provided with the distribution.
- \* Neither the name of the Intel Corporation nor the names of its contributors may be used to endorse or promote products derived from this software without specific prior written permission.

THIS SOFTWARE IS PROVIDED BY INTEL CORPORATION "AS IS" AND ANY EXPRESS OR IMPLIED WARRANTIES, INCLUDING, BUT NOT LIMITED TO, THE IMPLIED WARRANTIES OF MERCHANTABILITY AND FITNESS FOR A PARTICULAR PURPOSE ARE DISCLAIMED. IN NO EVENT SHALL INTEL CORPORATION OR CONTRIBUTORS BE LIABLE FOR ANY DIRECT, INDIRECT, INCIDENTAL, SPECIAL, EXEMPLARY, OR CONSEQUENTIAL DAMAGES (INCLUDING, BUT NOT LIMITED TO, PROCUREMENT OF SUBSTITUTE GOODS OR SERVICES; LOSS OF USE, DATA, OR PROFITS; OR BUSINESS INTERRUPTION) HOWEVER CAUSED AND ON ANY THEORY OF LIABILITY, WHETHER IN CONTRACT, STRICT LIABILITY, OR TORT (INCLUDING NEGLIGENCE OR OTHERWISE) ARISING IN ANY WAY OUT OF THE USE OF THIS SOFTWARE, EVEN IF ADVISED OF THE POSSIBILITY OF SUCH DAMAGE.

##+end\_quote

\* Simple permissive licenses

For files:  
- cipher/crc.c

##+begin\_quote  
Copyright (c) 1996 L. Peter Deutsch

Permission is granted to copy and distribute this document for any purpose and without charge, including translations into other languages and incorporation into compilations, provided that the copyright notice and this notice are preserved, and that any substantive changes or deletions from the original are clearly marked.

\* IETF permissive licenses

For files:  
- cipher/crc.c

##+begin\_quote  
Copyright (C) The Internet Society (1998). All Rights Reserved.

This document and translations of it may be copied and furnished to others, and derivative works that comment on or otherwise explain it or assist in its implementation may be prepared, copied, published and distributed, in whole or in part, without restriction of any kind, provided that the above copyright notice and this paragraph are included on all such copies and derivative works. However, this document itself may not be modified in any way, such as by removing the copyright notice or references to the Internet Society or other Internet organizations, except as needed for the purpose of developing Internet standards in which case the procedures for copyrights defined in the Internet Standards process must be followed, or as required to translate it into languages other than English.

The limited permissions granted above are perpetual and will not be revoked by the Internet Society or its successors or assigns.

This document and the information contained herein is provided on an "AS IS" basis and THE INTERNET SOCIETY AND THE INTERNET ENGINEERING TASK FORCE DISCLAIMS ALL WARRANTIES, EXPRESS OR IMPLIED, INCLUDING BUT NOT LIMITED TO ANY WARRANTY THAT THE USE OF THE INFORMATION HEREIN WILL NOT INFRINGE ANY RIGHTS OR ANY IMPLIED WARRANTIES OF MERCHANTABILITY OR FITNESS FOR A PARTICULAR PURPOSE.

#+end\_quote

\* X License

For files:  
- install.sh

#+begin\_quote

Copyright (C) 1994 X Consortium

Permission is hereby granted, free of charge, to any person obtaining a copy of this software and associated documentation files (the "Software"), to deal in the Software without restriction, including without limitation the rights to use, copy, modify, merge, publish, distribute, sublicense, and/or sell copies of the Software, and to permit persons to whom the Software is furnished to do so, subject to the following conditions:

The above copyright notice and this permission notice shall be included in all copies or substantial portions of the Software.

THE SOFTWARE IS PROVIDED "AS IS", WITHOUT WARRANTY OF ANY KIND, EXPRESS OR IMPLIED, INCLUDING BUT NOT LIMITED TO THE WARRANTIES OF MERCHANTABILITY, FITNESS FOR A PARTICULAR PURPOSE AND NONINFRINGEMENT. IN NO EVENT SHALL THE X CONSORTIUM BE LIABLE FOR ANY CLAIM, DAMAGES OR OTHER LIABILITY, WHETHER IN AN ACTION OF CONTRACT, TORT OR OTHERWISE, ARISING FROM, OUT OF OR IN CONNECTION WITH THE SOFTWARE OR THE USE OR OTHER DEALINGS IN THE SOFTWARE.

Except as contained in this notice, the name of the X Consortium shall not be used in advertising or otherwise to promote the sale, use or other dealings in this Software without prior written authorization from the X Consortium.

#+end\_quote

Libgpg-error 1.12

Package: libgpg-error

Maintainer: Werner Koch <wk@gnupg.org>

Bug reports: bug-gnupg@gnupg.org

Mailing list: gnupg-devel@gnupg.org

Security related bug reports: security@gnupg.org

License (library): LGPLv2.1+

License (tools): GPLv2+ with exception

Aron Xu <happyaron.xu at gmail.com>  
- TRANSLATION [zh\_CN]

Clytie Siddall <clytie at riverland.net.au>  
- TRANSLATION [vi]

Daniel Nylander <po at danielnylander.se>  
- TRANSLATION [sv]

David Prévot <david at tilapin.org>  
- TRANSLATION [fr]

Felipe Castro <fefcas at gmail.com>  
- TRANSLATION [eo]

Francesco Groccia <fgr at anche.no>  
- TRANSLATION [it]

Freek de Kruijf <f.de.kruijf at gmail.com>  
- TRANSLATION [nl]

g10 Code GmbH <code at g10code.com>  
- Design and implementation.

Jakub Bogusz <qboosh at pld-linux.org>  
- TRANSLATION [pl]

Joe Hansen <joedalton2 at yahoo.dk>  
- TRANSLATION [da]

Laurentiu Buzdugan <lbuz at rolux.org>  
- TRANSLATION [ro]

Petr Písar <petr.pisar at atlas.cz>  
- TRANSLATION [cs]

Robert Schiele <rschiele at uni-mannheim.de>  
- libgpg-error.spec

Stephane Roy <sroy at j2n.net>  
- TRANSLATION [fr]

Takeshi Hamasaki <hmatrjp at users.sourceforge.jp>  
- TRANSLATION [fr]

Werner Koch <wk at gnupg.org>  
- TRANSLATION [de]

Yasuaki Taniguchi <yasuakit at gmail.com>  
- TRANSLATION [fr]

Yuri Chornoivan <yurchor at ukr.net>  
- TRANSLATION [uk]

Copyright 2003, 2004, 2005, 2006, 2007, 2013 g10 Code GmbH

This file is free software; as a special exception the author gives unlimited permission to copy and/or distribute it, with or without modifications, as long as this notice is preserved.

This file is distributed in the hope that it will be useful, but WITHOUT ANY WARRANTY, to the extent permitted by law; without even the implied warranty of MERCHANTABILITY or FITNESS FOR A PARTICULAR PURPOSE.

Noto Sans CJK JP Regular  
Copyright 2012 Google Inc. All Rights Reserved.

This Font Software is licensed under the SIL Open Font License, Version 1.1.  
(<https://fonts.google.com/noto/specimen/Noto+Sans+JP>)

**SHARP**  
SHARP CORPORATION