

SHARP[®]

PN-B501

PN-B401

LCD MONITOR

OPERATION MANUAL

HDMI

IMPORTANT:

To aid reporting in case of loss or theft, please record the product's model and serial numbers in the space provided. The numbers are located in the rear of the product.



Model No.:

Serial No.:

U.S.A. ONLY

IMPORTANT INFORMATION

WARNING: TO REDUCE THE RISK OF FIRE OR ELECTRIC SHOCK, DO NOT EXPOSE THIS PRODUCT TO RAIN OR MOISTURE.

	CAUTION RISK OF ELECTRIC SHOCK DO NOT OPEN	
<p>CAUTION: TO REDUCE THE RISK OF ELECTRIC SHOCK, DO NOT REMOVE COVER. NO USER-SERVICEABLE PARTS INSIDE. REFER SERVICING TO QUALIFIED SERVICE PERSONNEL.</p>		



The lightning flash with arrowhead symbol, within a triangle, is intended to alert the user to the presence of uninsulated “dangerous voltage” within the product’s enclosure that may be of sufficient magnitude to constitute a risk of electric shock to persons.



The exclamation point within a triangle is intended to alert the user to the presence of important operating and maintenance (servicing) instructions in the literature accompanying the product.

WARNING:

FCC Regulations state that any unauthorized changes or modifications to this equipment not expressly approved by the manufacturer could void the user’s authority to operate this equipment.

NOTE:

This equipment has been tested and found to comply with the limits for Class A digital device, pursuant to Part 15 of the FCC Rules. These limits are designed to provide reasonable protection against harmful interference when the equipment is operated in a commercial environment. This equipment generates, uses, and can radiate radio frequency energy and, if not installed and used in accordance with the instruction manual, may cause harmful interference to radio communications. Operation of this equipment in a residential area is likely to cause harmful interference in which case the user will be required to correct the interference at his own expense.

This product utilizes a CR coin Lithium battery which contains a Perchlorate material. Special handling for this material may apply, California residents, See www.dtsc.ca.gov/hazardouswaste/perchlorate/ Others, consult local environmental officers.

U.S.A. ONLY

DEAR SHARP CUSTOMER

Thank you for your purchase of a SHARP LCD product. To ensure safety and many years of trouble-free operation of your product, please read the Safety Precautions carefully before using this product.

SAFETY PRECAUTIONS

Electricity is used to perform many useful functions, but it can also cause personal injuries and property damage if improperly handled. This product has been engineered and manufactured with the highest priority on safety. However, improper use can result in electric shock and/or fire. In order to prevent potential danger, please observe the following instructions when installing, operating and cleaning the product. To ensure your safety and prolong the service life of your LCD product, please read the following precautions carefully before using the product.

1. Read instructions — All operating instructions must be read and understood before the product is operated.
2. Keep this manual in a safe place — These safety and operating instructions must be kept in a safe place for future reference.
3. Observe warnings — All warnings on the product and in the instructions must be observed closely.
4. Follow instructions — All operating instructions must be followed.
5. Cleaning — Unplug the power cord from the power outlet before cleaning the product. Use a dry cloth to clean the product. Do not use liquid cleaners or aerosol cleaners. Do not use dirty cloths. Doing so may damage the product.
6. Attachments — Do not use attachments not recommended by the manufacturer. Use of inadequate attachments can result in accidents.
7. Water and moisture — Do not use the product near water. Do not install the product in a place where water may splash onto it. Be careful of equipment which drains water such as an air-conditioner.
8. Ventilation — The vents and other openings in the cabinet are designed for ventilation. Do not cover or block these vents and openings since insufficient ventilation can cause overheating and/or shorten the life of the product. Do not place the product on a sofa, rug or other similar surface, since they can block ventilation openings. Do not place the product in an enclosed place such as a bookcase or rack, unless proper ventilation is provided or the manufacturer's instructions are followed.
9. Power cord protection — The power cords must be routed properly to prevent people from stepping on them or objects from resting on them.
10. The LCD panel used in this product is made of glass. Therefore, it can break when the product is dropped or applied with impact. Be careful not to be injured by broken glass pieces in case the LCD panel breaks.
11. Overloading — Do not overload power outlets or extension cords. Overloading can cause fire or electric shock.
12. Entering of objects and liquids — Never insert an object into the product through vents or openings. High voltage flows in the product, and inserting an object can cause electric shock and/or short internal parts. For the same reason, do not spill water or liquid on the product.
13. Servicing — Do not attempt to service the product yourself. Removing covers can expose you to high voltage and other dangerous conditions. Request a qualified service person to perform servicing.
14. Repair — If any of the following conditions occurs, unplug the power cord from the power outlet, and request a qualified service person to perform repairs.
 - a. When the power cord or plug is damaged.
 - b. When a liquid was spilled on the product or when objects have fallen into the product.
 - c. When the product has been exposed to rain or water.
 - d. When the product does not operate properly as described in the operating instructions.

Do not touch the controls other than those described in the operating instructions. Improper adjustment of controls not described in the instructions can cause damage, which often requires extensive adjustment work by a qualified technician.
 - e. When the product has been dropped or damaged.
 - f. When the product displays an abnormal condition. Any noticeable abnormality in the product indicates that the product needs servicing.
15. Replacement parts — In case the product needs replacement parts, make sure that the service person uses replacement parts specified by the manufacturer, or those with the same characteristics and performance as the original parts. Use of unauthorized parts can result in fire, electric shock and/or other danger.
16. Safety checks — Upon completion of service or repair work, request the service technician to perform safety checks to ensure that the product is in proper operating condition.
17. Wall mounting — When mounting the product on a wall, be sure to install the product according to the method recommended by the manufacturer.
18. Heat sources — Keep the product away from heat sources such as radiators, heaters, stoves and other heat-generating products (including amplifiers).

SAFETY PRECAUTIONS (Continued)

19. Batteries — Incorrect use of batteries may cause the batteries to burst or ignite. A leaky battery may corrode the equipment, dirty your hands or spoil your clothing. In order to avoid these problems, make sure to observe the precautions below:
 - Use the specified batteries only.
 - Install the batteries with due attention to the plus (+) and minus (-) sides of the batteries according to the instructions in the compartment.
 - Do not mix old and new batteries.
 - Do not mix batteries of different types. Voltage specifications of batteries of the same shape may vary.
 - Replace an exhausted battery with a new one promptly.
 - If you will not use the remote control for a long time, remove the batteries.
 - If leaked battery fluid gets on your skin or clothing, rinse immediately and thoroughly. If it gets into your eye, bathe your eye well rather than rubbing and seek medical treatment immediately. Leaked battery fluid that gets into your eye or your clothing may cause a skin irritation or damage your eye.
20. Usage of the monitor must not be accompanied by fatal risks or dangers that, could lead directly to death, personal injury, severe physical damage or other loss, including nuclear reaction control in nuclear facility, medical life support system, and missile launch control in a weapon system.
21. Do not stay in contact with the parts of the product that become hot for long periods of time. Doing so may result in low-temperature burns.
22. Do not modify this product.

WARNING:

This is a Class A product. In a domestic environment this product may cause radio interference in which case the user may be required to take adequate measures.

An apparatus with CLASS I construction shall be connected to a MAIN socket outlet with a protective earthing connection.

To maintain compliance with EMC regulations, use shielded cables to connect to the following terminals: HDMI input terminal, D-sub input terminal, RS-232C input/output terminals, and DisplayPort input/output terminals.

If a monitor is not positioned in a sufficiently stable location, it can be potentially hazardous due to falling. Many injuries, particularly to children, can be avoided by taking simple precautions such as:

- Using fixing devices like wall mount brackets recommended by the manufacturer.
- Only using furniture that can safely support the monitor.
- Ensuring the monitor is not overhanging the edge of the supporting furniture.
- Not placing the monitor on tall furniture (for example, cupboards or bookcases) without anchoring both the furniture and the monitor to a suitable support.
- Not standing the monitors on cloth or other materials placed between the monitor and supporting furniture.
- Educating children about the dangers of climbing on furniture to reach the monitor or its controls.
- This equipment is not suitable for use in locations where children are likely to be present unsupervised.

Especially for child safety

- Don't allow children to climb on or play with the monitor.
- Don't place the monitor on furniture that can easily be used as steps, such as a chest of drawers.
- Remember that children can become excited while watching a program, especially on a "larger than life" monitor. Care should be taken to place or install the monitor where it cannot be pushed, pulled over, or knocked down.
- Care should be taken to route all cords and cables connected to the monitor so that they cannot be pulled or grabbed by curious children.

TIPS AND SAFETY INSTRUCTIONS

- The TFT color LCD panel used in this monitor is made with the application of high precision technology. However, there may be minute points on the screen where pixels never light or are permanently lit. Also, if the screen is viewed from an acute angle there may be uneven colors or brightness. Please note that these are not malfunctions but common phenomena of LCDs and will not affect the performance of the monitor.
- Do not display a still picture for a long period, as this could cause a residual image.
- Never rub or tap the monitor with hard objects.
- Please understand that SHARP CORPORATION bears no responsibility for errors made during use by the customer or a third party, nor for any other malfunctions or damage to this product arising during use, except where indemnity liability is recognized under law.
- This monitor and its accessories may be upgraded without advance notice.
- Do not use the monitor where there is a lot of dust, where humidity is high, or where the monitor may come into contact with oil or steam. Do not use in an environment where there are corrosive gases (sulfur dioxide, hydrogen sulfide, nitrogen dioxide, chlorine, ammonia, ozone, etc.). As this could lead to fire.
- Ensure that the monitor does not come into contact with water or other fluids. Ensure that no objects such as paper clips or pins enter the monitor as this could lead to fire or electric shock.
- Do not place the monitor on top of unstable objects or in unsafe places. Do not allow the monitor to receive strong shocks or to strongly vibrate. Causing the monitor to fall or topple over may damage it.
- Do not use the monitor near heating equipment or in places where there is likelihood of high temperature, as this may lead to generation of excessive heat and outbreak of fire.
- Do not use the monitor in places where it may be exposed to direct sunlight. Risk of cabinet deformation and failure if the monitor is used in direct sunlight.
- If the monitor is installed in a location exposed to sunlight such as next to a window, measures to reduce ultraviolet and infrared radiation and temperature measures are required. For details, consult your dealer.
- Please be sure to constantly remove dust and garbage that has attached to the ventilation opening. If dust collects in the ventilation opening or the inside of the monitor, it may lead to excessive heat, outbreak of fire, or malfunction. Please request a cleaning of the inside of the monitor from an authorized SHARP servicing dealer or service center.
- Images cannot be rotated on this monitor. When using in portrait orientation, you will need to prepare appropriately orientated content in advance.
- The power outlet shall be installed near the equipment and shall be easily accessible.
- Continuous operating time and warranty. This product is designed for a maximum daily use of 16 hours. Continual use in excess of 16 hours per day is not covered by the warranty.
- Restarting the Android system. To maintain stable operation of APPLICATION mode, the Android system must be restarted once a day. A SCHEDULE is set by factory default in this monitor that restarts the system at 3:00 AM (see page 31).

- If you or a third party uses the product incorrectly, or if the product is subjected to the effects of static electricity or electrical noise, or if the product malfunctions or is repaired, there is a risk that saved data will be corrupted or lost.
- Always back up important data to a USB flash drive or SD memory card.
- We bear no responsibility for protection of internal memory recorded content or related damages.

The Power Cord

- Use only the power cord supplied with the monitor.
- Do not damage the power cord nor place heavy objects on it, stretch it or over bend it. Also, do not add extension cords. Damage to the cord may result in fire or electric shock.
- Do not use the power cord with a power tap. Adding an extension cord may lead to fire as a result of overheating.
- Do not remove or insert the power plug with wet hands. Doing so could result in electric shock.
- Unplug the power cord if it is not used for a long time.
- Do not attempt to repair the power cord if it is broken or malfunctioning. Refer the servicing to the service representative.

Manual Scope

- Microsoft and Windows are either registered trademarks or trademarks of Microsoft Corporation in the United States and/or other countries.
- The terms HDMI and HDMI High-Definition Multimedia Interface, and the HDMI Logo are trademarks or registered trademarks of HDMI Licensing Administrator, Inc. in the United States and other countries.
- DisplayPort is a registered trademark of Video Electronics Standards Association.
- Google and Android are trademarks or registered trademarks of Google LLC.
- Ethernet is a registered trademark of Xerox Corporation.
- VESA is either registered trademark or trademark of Video Electronics Standards Association in the United States and/or other countries.
- All other brand and product names are trademarks or registered trademarks of their respective holders.
- Language of OSD menu used in this manual is English by way of example.
- Illustrations in this manual may not exactly represent the actual product or display.
- This manual assumes use in landscape orientation, except where specifically noted.

LED Backlight

- The LED backlight in this product has a limited lifetime.
 - * If the screen gets dark or does not turn on, it may be necessary to replace the LED backlight.
 - * This LED backlight is exclusive to this product and must be replaced by an authorized SHARP servicing dealer or service center. Please contact an authorized SHARP servicing dealer or service center for assistance.

MOUNTING PRECAUTIONS

- This product is for use indoors.
- A mounting bracket compliant with VESA specifications is required.
- Since the monitor is heavy, consult your dealer before installing, removing or moving the monitor.
- Mounting the monitor on the wall requires special expertise and the work must be performed by an authorized SHARP dealer. You should never attempt to perform any of this work yourself. Our company will bear no responsibility for accidents or injuries caused by improper mounting or mishandling.
- Use the monitor with the surface perpendicular to a level surface. If necessary, the monitor may be tilted up to 20 degrees upward or downward.
- This monitor should be used at an ambient temperature between 32°F (0°C) and 104°F (40°C). Provide enough space around the monitor to prevent heat from accumulating inside.

For the monitor in landscape orientation

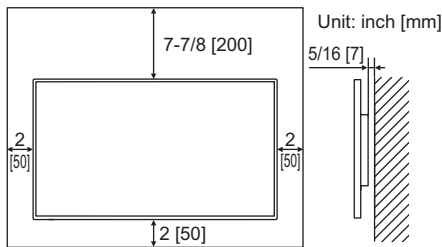

For the monitor in portrait orientation

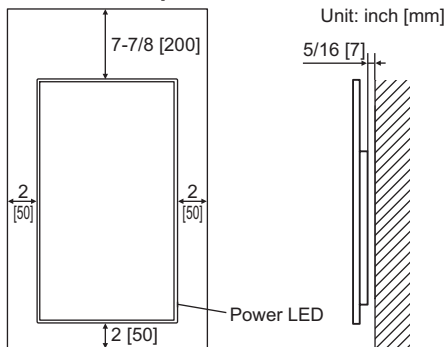

- If it is difficult to provide sufficient space for any reason such as the installation of the monitor inside a housing or of several units side-by-side, or if the ambient temperature may be outside of the range of 32°F (0°C) to 104°F (40°C), install a fan or take other measures to keep the ambient temperature within the required range.
- When installing two or more monitor units side-by-side, provide space of at least 3/16 inch (5 mm) around them to prevent stress on the adjacent unit or structure due to thermal expansion.
- Temperature condition may change when using the monitor together with the optional equipments recommended by SHARP. In such cases, please check the temperature condition specified by the optional equipments.
- Do not block any ventilation openings. If the temperature inside the monitor rises, this could lead to a malfunction.
- Do not place the monitor on a device which generates heat.

- Adhere to the following when installing the monitor in its portrait orientation. Failing to adhere to the following may cause malfunctions.
 - Install the monitor such that the power LED is located on the right side.
 - Set the PORTRAIT/LANDSCAPE INSTALL in the MONITOR menu to PORTRAIT. (See page 27.)
 - Be sure to clamp the power cord (supplied) by using the supplied cable clamp (affixing type). When clamping the power cord, take care not to stress the terminal of the power cord. Do not bend the power cord excessively.

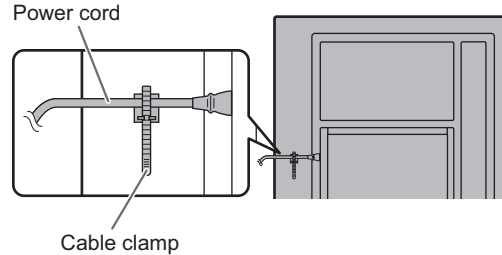

Mounting the monitor laying flat on a surface

- When using this monitor laying flat on a surface (when the monitor is tilted more than 20 degrees upward or downward from the perpendicular in relation to a level surface), consult an authorized SHARP dealer because there are some specific mounting conditions.

Adhere to the following. Failing to adhere to the following may cause malfunctions.

- This monitor can be tilted up to 90 degrees upward or downward.
- Set HORIZONTAL INSTALLATION in the MONITOR menu to FACE UP or FACE DOWN. (See page 27.)
- Use this monitor at the ambient temperature within the range of 32°F (0°C) to 86°F (30°C). Provide 7-7/8 inch (200 mm) or more space between the monitor and the ceiling or other mounting surfaces and surrounding objects to prevent heat from accumulating inside. If it is difficult to provide sufficient space or if the ambient temperature may be outside of the range of 32°F (0°C) to 86°F (30°C), install a fan or take other measures to keep the ambient temperature within the required range.

For the monitor laying flat on a surface (facing up)

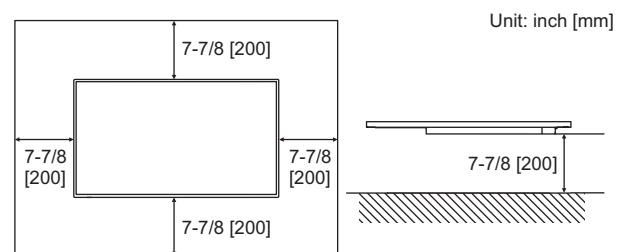

For the monitor laying flat on a surface (facing down)

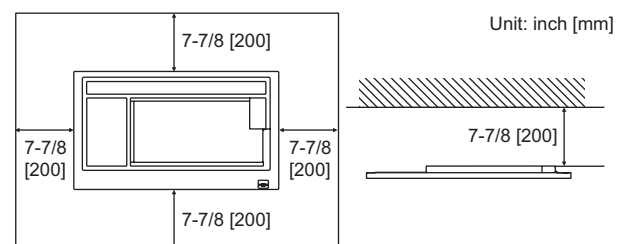

- Do not press hard on the LCD panel or otherwise subject it to impacts.

Contents

IMPORTANT INFORMATION	3	Initialization (Reset)/Functional Restriction Setting (FUNCTION)	33
DEAR SHARP CUSTOMER	4	Controlling the Monitor with a computer (RS-232C) ...	35
SAFETY PRECAUTIONS	4	Computer connection	35
TIPS AND SAFETY INSTRUCTIONS	6	Communication conditions	35
MOUNTING PRECAUTIONS	7	Communication procedure	35
Supplied Components	8	RS-232C command table.....	39
Part Names	9	Controlling the Monitor with a computer (LAN).....	43
Connecting Peripheral Equipment	11	Command-based control.....	43
Connecting the Power Cord	13	Troubleshooting	44
Binding Cables	13	Specifications	45
Attaching the logo sticker	14	Mounting Precautions	
Attaching the USB flash drive / SD card cover	14	(For SHARP dealers and service engineers).....	50
Preparing the Remote Control Unit	15		
Installing the batteries	15		
Remote control operation range.....	15		
Turning Power On/Off	17		
Turning on the main power.....	17		
Turning power on/off	17		
Disabling power on/off operations	18		
Basic Operation	19		
Menu Items	22		
Displaying the menu screen.....	22		
Menu item details	23		
Adjustments for computer screen display	32		

Supplied Components

If any component should be missing, please contact your dealer.

- Liquid Crystal Display Monitor: 1
- Remote control unit: 1
- Power cord: 1
- R-03 battery ("AAA" size): 2
- CD-ROM (Utility Disk for Windows): 1
- Setup Manual: 1
- Cable clamp: 2
- Logo sticker: 1
- USB flash drive / SD card cover: 1
- USB flash drive / SD card cover fixing screw: 1

* SHARP Corporation holds authorship rights to the Utility Disk program. Do not reproduce it without permission.

* For environmental protection!

Do not dispose of batteries in household waste. Follow the disposal instructions for your area.

TIPS

- SHARP Content Distributor setup program can be downloaded using Information Display Downloader. Install Information Display Downloader.
- When the Information Display Downloader is installed, you can check and download the most recent versions of the software programs.
- To install and use the software, see the manual for each.

Part Names

■ Front view

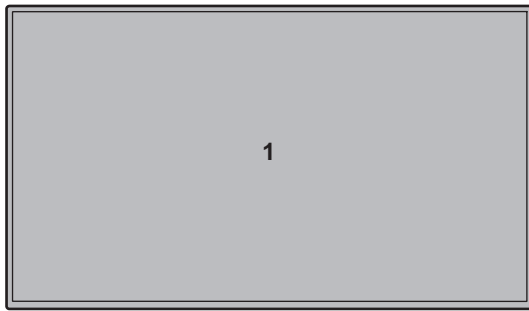

■ Rear view

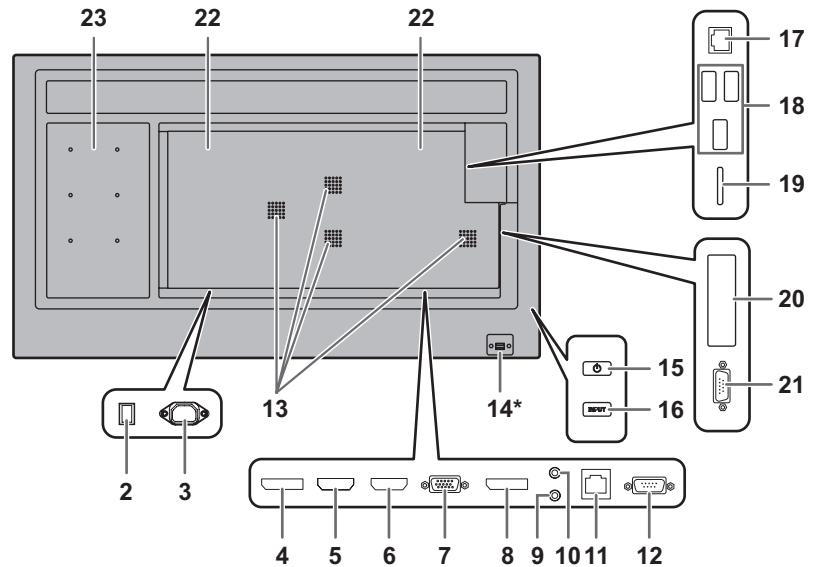

* How to pull out the power LED/remote control sensor

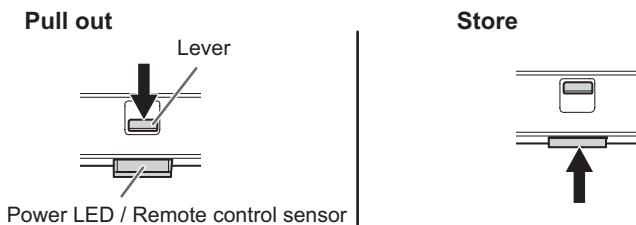

- Slide the lever on the rear of the monitor to pull out the power LED/remote control sensor. Press the power LED/remote control sensor directly to store it inside the monitor.

1. **LCD panel**
2. **Main power switch** (See page 13.)
3. **AC input terminal** (See page 13.)
4. **DisplayPort output terminal** (See page 11.)
5. **HDMI1 input terminal** (See page 11.)
6. **HDMI2 input terminal** (See page 11.)
7. **D-sub input terminal** (See page 11.)
8. **DisplayPort input terminal** (See page 11.)
9. **Audio input terminal** (See page 12.)
10. **Audio output terminal** (See page 12.)
11. **Optional terminal**
This terminal is provided for possible future (optional) function expansion. Offering of this terminal is not a guarantee that future expanded functionality will be released.
12. **RS-232C input terminal** (See page 12.)
13. **Vents**
14. **Power LED** (See page 17.) / **Remote control sensor** (See page 15.)
15. **POWER button** (See page 17.)
16. **INPUT button** (See page 20.)
17. **LAN terminal** (See page 12.)
18. **USB port** (See page 12.)
19. **SD card slot** (See page 12.)
20. **Expansion slot**
This section is used to connect optional hardware for function expansion. Offering this attachment location is not a guarantee that future compatible hardware attachments will be released.
21. **RS-232C output terminal** (See page 12.)
22. **Speakers**
23. **Optional attachment section (PN-B501 only)**
This section is used to connect optional hardware for function expansion. Offering this attachment location is not a guarantee that future compatible hardware attachments will be released.

! Caution

- Consult your SHARP dealer for attachment/detachment of optional parts.

Part Names

■ Remote control unit

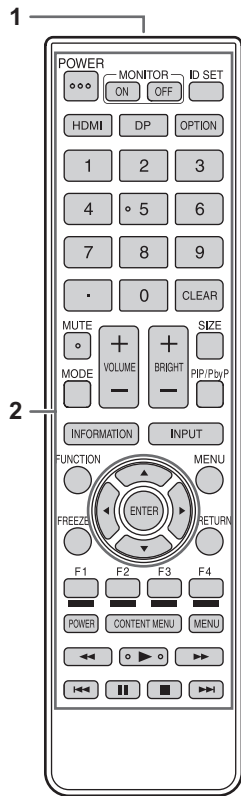

1. Signal transmitter
2. Operation buttons (See page 19.)

Connecting Peripheral Equipment

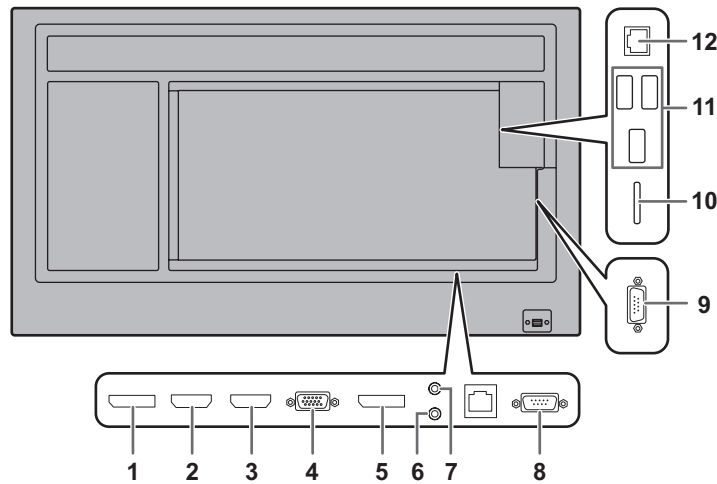

! Caution

- Be sure to turn off the main power switch and disconnect the plug from the power outlet before connecting/disconnecting cables. Also, read the manual of the equipment to be connected.
- Be careful not to confuse the input terminal with the output terminal when connecting cables. Accidentally reversing cables connected to the input and output terminals may cause malfunctions and the other problems.
- Do not use any cable that has a damaged or deformed terminal. Using such cables may cause malfunctions.

TIPS

- Images may not be displayed properly depending on the computer (video card) to be connected.
- Use the automatic screen adjustment when a computer screen is displayed for the first time using D-SUB[RGB] or when the setting of the computer is changed. The screen is adjusted automatically when SELF ADJUST in the MONITOR menu is set to ON.
- If the audio output from the playback device is connected directly to speakers or other devices, the video on the monitor may appear delayed from the audio portion. Audio should be played through this monitor by connecting the playback device to the monitor's audio input, and connecting the monitor's audio output to the speakers or other devices.
- The audio input terminals used in each input mode are factory-set as follows.

Input mode	Audio input terminal (Factory setting)
DisplayPort	DisplayPort input terminal
HDMI1	HDMI1 input terminal
HDMI2	HDMI2 input terminal
D-SUB[RGB], D-SUB[COMPONENT]	Audio input terminal

1. DisplayPort output terminal

- The video of the current input mode can be output to an external device.
 - Use a commercially available DisplayPort cable.
 - Outputting HDCP-encrypted video requires an external device which supports HDCP.
 - This terminal can be used to make a daisy chain connection* by connecting these monitors to each other through the DisplayPort input terminal of each monitor.
- *: Up to 4 monitors.

TIPS

- The length of the signal cables or surrounding environment may affect the image quality.
- The output screen may not be displayed properly. In this case, turn off the power to all the monitors connected in a daisy chain and then turn the power on again.
- When connecting monitors in a daisy chain set NO SIGNAL AUTO INPUT SEL. to OFF.
- Video output is disabled in the following cases:
When the power is turned off.
When the monitor is in input signal waiting mode.

2. HDMI1 input terminal

3. HDMI2 input terminal

- Use a commercially available HDMI cable (conforming to the HDMI standard).
- Select the audio input terminal to be used in HDMI1 or HDMI2 of AUDIO SELECT on the SETUP menu. When HDMI is selected, it is not necessary to connect an audio cable to the audio input terminal.

4. D-sub input terminal

- Set D-SUB of INPUT SELECT on the SETUP menu according to the device to be connected.

5. DisplayPort input terminal

- Use a commercially available DisplayPort cable.
- Select the audio input terminal to be used in DisplayPort of AUDIO SELECT on the SETUP menu. When DisplayPort is selected, it is not necessary to connect an audio cable to the audio input terminal.

Connecting Peripheral Equipment

6. Audio input terminal

- Use an audio cable without resistance.
- Set the audio input terminal to be used in AUDIO SELECT on the SETUP menu.

7. Audio output terminal

- The output sound varies depending on the input mode.

8. RS-232C input terminal

9. RS-232C output terminal

- You can control the monitor from a computer by connecting a commercially available RS-232 straight cable between these terminals and the computer.

10. SD card slot

- This is used in APPLICATION mode. For details, see the Software Guide.

11. USB port

- This is used in APPLICATION mode. For details, see the Software Guide.

12. LAN terminal

- You can control the monitor from a computer on a network by connecting a commercially available LAN cable between this terminal and a network.

Connecting the Power Cord

! Caution

- Use only the power cord supplied with the monitor.
1. Turn off the main power switch.
 2. Plug the power cord (supplied) into the AC input terminal.
 3. Plug the power cord (supplied) into the power outlet.

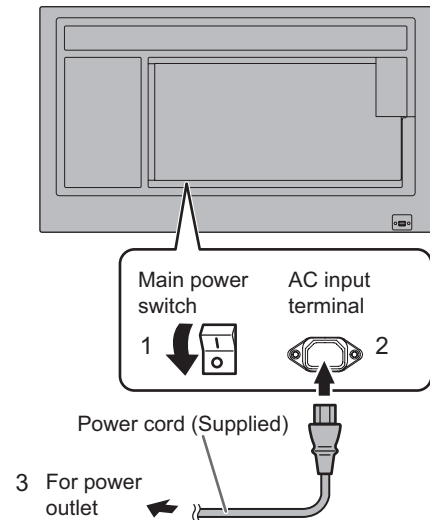

Binding Cables

The supplied cable clamps (affixing type) can be used to clamp the power code and cables connected to the back of the monitor.

! Caution

- Attach the supplied cable clamps to a flat surface. Do not attach over a vent.
- Remove any dust or dirt before attaching.

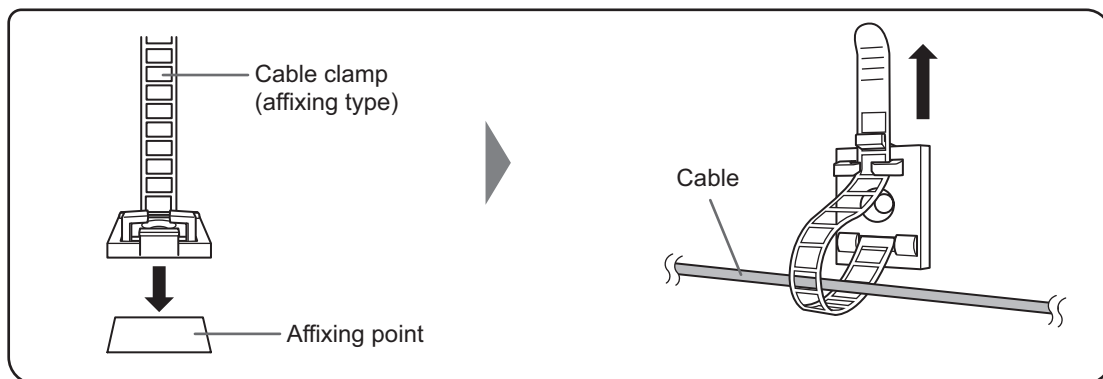

Attaching the logo sticker

You can attach the supplied logo sticker on the monitor.
Refer to the following example to attach the sticker as necessary.

Example for landscape orientation

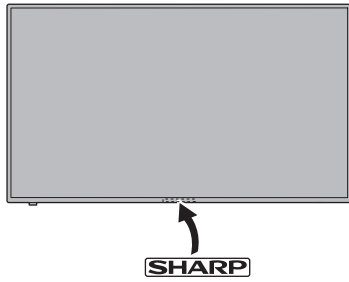

Example for portrait orientation



Attaching the USB flash drive / SD card cover

1. Attach the USB flash drive / SD card cover (supplied) to this monitor.

USB flash drive / SD card cover (supplied)

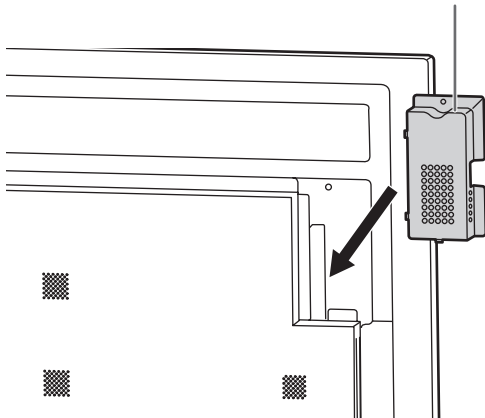

TIPS

- If the cover will be attached, use a USB flash drive no larger than 2-3/4 inch (70 mm) (L) (excluding the terminal) x 11/16 inch (17 mm) (W) x 5/16 inch (8 mm) (H).

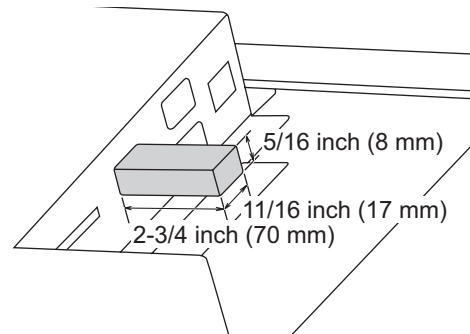

2. Secure the cover using USB flash drive / SD card cover fixing screw (supplied).

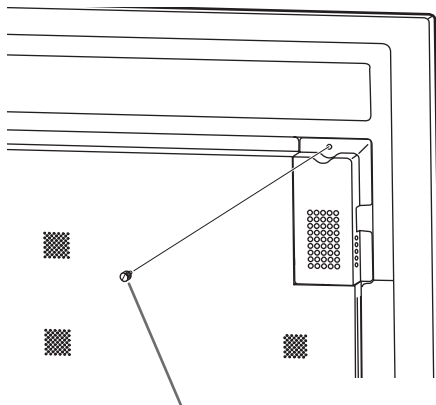

USB flash drive / SD card cover fixing screw (supplied)

Preparing the Remote Control Unit

Installing the batteries

1. Place your finger on the part marked with the ▲, and then pull the cover off.

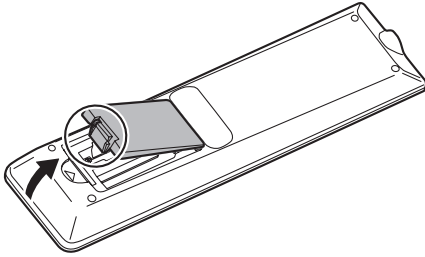

2. See the instructions in the compartment and put in the supplied batteries (R-03 ("AAA" size) x 2) with their plus (+) and minus (-) sides oriented correctly.
3. Close the cover.

TIPS

- When the batteries become exhausted, replace them with new (commercially available) batteries.
- The supplied batteries (R-03 ("AAA" size) x 2) may become exhausted quickly depending on how they are stored.
- If you will not be using the remote control for a long time, remove the batteries.
- Use manganese or alkaline batteries only.

Remote control operation range

Remote control sensor in

The remote control can be operated even when the remote control sensor is stored inside the monitor.

Point the remote control unit toward the remote control sensor on the bottom of the monitor (or the right side of the monitor if using portrait orientation).

For the monitor in landscape orientation

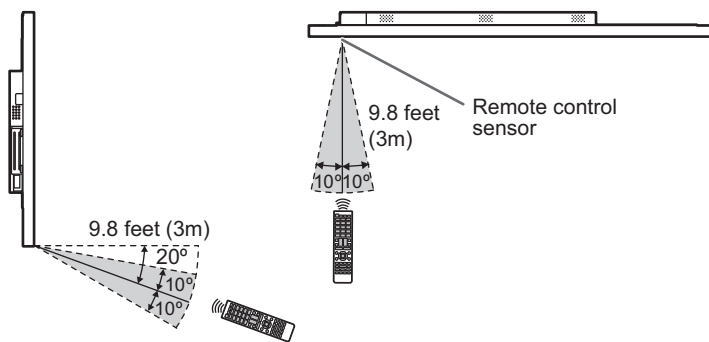

For the monitor in portrait orientation

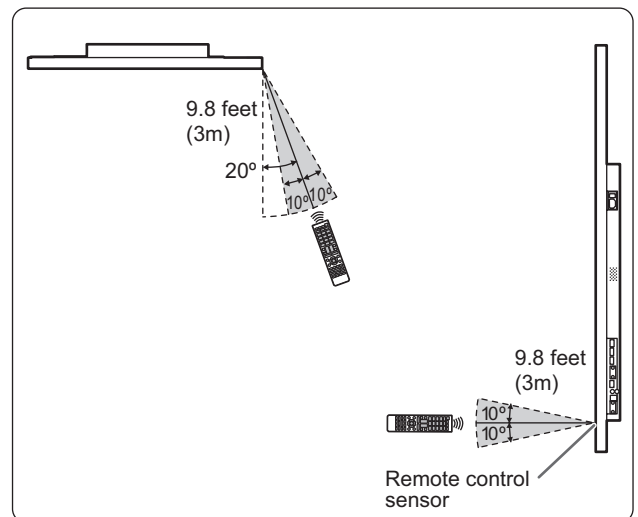

Preparing the Remote Control Unit

Remote control sensor out

Point the remote control unit toward the remote control sensor on the front of the monitor.

For the monitor in landscape orientation

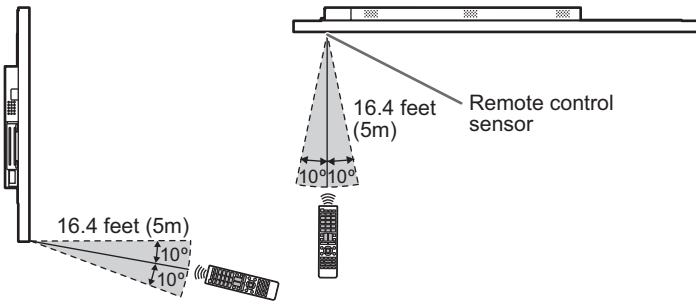

For the monitor in portrait orientation

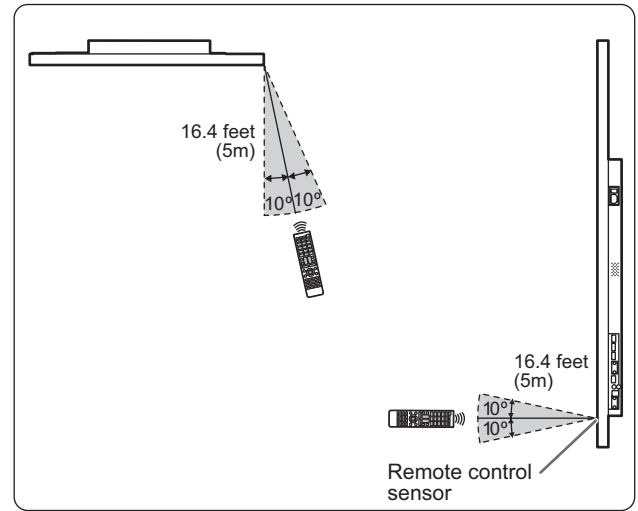

TIPS

- Do not expose the remote control unit to shock by dropping or stepping on it. This could lead to a malfunction.
- Do not expose the remote control unit to liquids, and do not place it in an area with high humidity.
- The remote control unit may not work properly if the remote control sensor is under direct sunlight or strong lighting.
- Objects between the remote control unit and the remote control sensor may prevent proper operation.
- Replace the batteries when they run low as this may shorten the remote control's operation range.
- If a fluorescent light is illuminated near the remote control unit, it may interfere with proper operation.
- Do not use it with the remote control of other equipment such as air conditioner, stereo components, etc.

Turning Power On/Off

! Caution

- Turn on the monitor first before turning on the computer or playback device.
- When switching the main power switch or the POWER button off and back on, always wait for at least 5 seconds. A short interval may result in a malfunction.

Turning on the main power

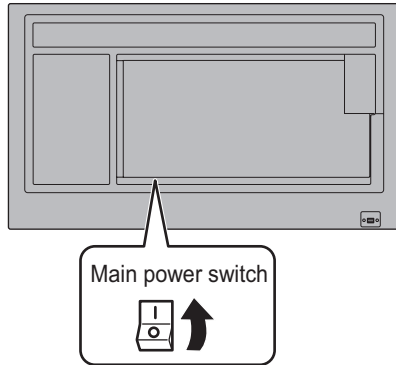

! Caution

- The main power must be turned on/off with the main power switch. Do not connect/disconnect the power cord or turn the breaker on/off while the main power switch is on.
- For a complete electrical disconnection, pull out the main plug.

Turning power on/off

Press the POWER button to turn the power ON/OFF. You can also turn the power ON/OFF by pressing the MONITOR ON button/MONITOR OFF button on the remote control unit.

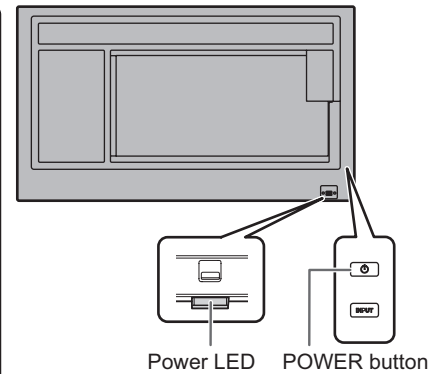
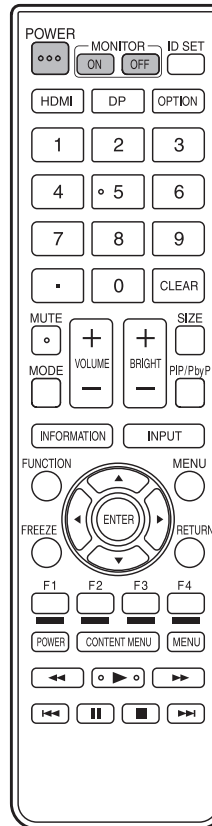

Status	Status of the monitor
Green lit	Power on
Orange lit	Power off (Standby mode)
Green flashing	Input signal waiting mode

TIPS

- When the main power switch is off, the monitor cannot be turned on.
- If the monitor is in the input signal waiting mode and you press the POWER button or MONITOR OFF button, the monitor enters standby mode.
- Setting the SCHEDULE flashes the power LED alternately in red and orange in standby mode.
- A SCHEDULE is set by factory default in this monitor that restarts the Android system at 3:00 AM.
- To disable the logo screen from displaying when turning the power ON, set LOGO SCREEN to OFF on the OTHERS menu. (See page 29.)

Turning Power On/Off

■ Operations after first power-on

When you turn on the power for the first time, a screen for setting the date and time appears.

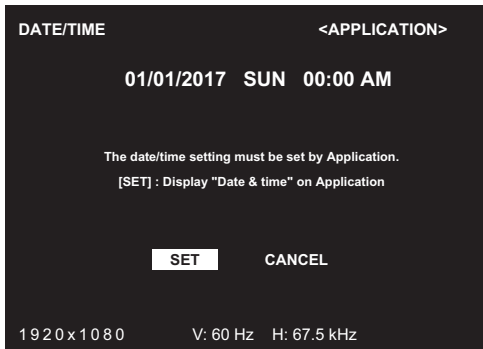

1. Select "SET", and set the time zone and date/time.

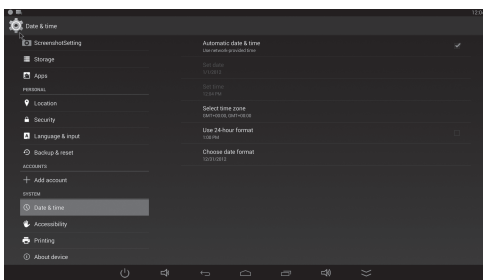

2. Select "Launcher:SHARP Open Architecture Platform" in "Home".

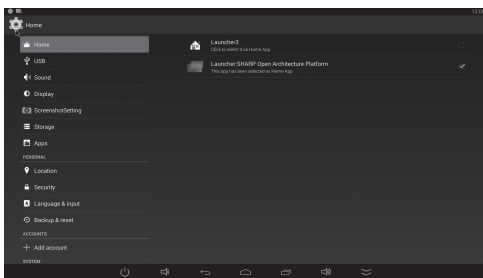

3. Press the CONTENT MENU button on the remote control unit.



This is the base screen (CONTENT MENU screen) when the input mode is APPLICATION.
For information on APPLICATION mode, see the Software Guide.

- Be sure to set the date and time.

TIPS

- The clock is maintained by the internal battery.
- If you already set the time but the date/time setting screen appears when the power is turned on, the internal battery may be exhausted. After replacing the internal battery, set the date and time as explained in step 1 on the left.
- Please contact an authorized SHARP servicing dealer or service center for assistance with internal battery replacement.
- Estimated service life of the internal battery: About 5 years (depending on monitor operation)
- The initial battery was inserted at the factory when the monitor was shipped, so it may run out of power before its expected operation life.

Disabling power on/off operations

Power on/power off operations can be disabled in order to protect the monitor from an accidental power off. Set the ADJUSTMENT LOCK in FUNCTION menu to "ON 2". (See page 33.)

Basic Operation

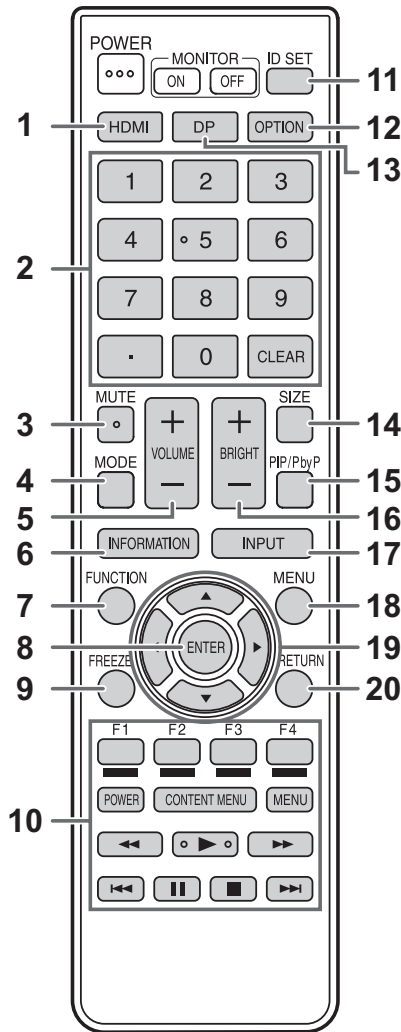

1. HDMI

Switch the input mode to HDMI1 or HDMI2.

2. Numeric input buttons

0 to 9 are also used in conjunction with the ID SET button.

3. MUTE

Turns off the volume temporarily.

Press the MUTE button again to turn the sound back to the previous level.

4. MODE (Color mode selection)

Each time you press this button, the color mode changes in the following order:

STD (Standard) → VIVID → sRGB →
HIGH ILLUMINANCE → STD...

- HIGH ILLUMINANCE is a display with colors suited to bright locations.
- sRGB cannot be used when input mode is D-SUB[COMPONENT].
sRGB is international standard of color representation specified by IEC (International Electrotechnical Commission). Color conversion is made in taking account of liquid crystal's characteristics and represents color tone close to its original image.

5. VOLUME +/- (Volume adjustment)

Pressing + or - displays the VOLUME menu.



Press + or - to adjust the volume.

* If you do not press any buttons for about 4 seconds, the VOLUME menu automatically disappears.

6. INFORMATION

Displays monitor information.

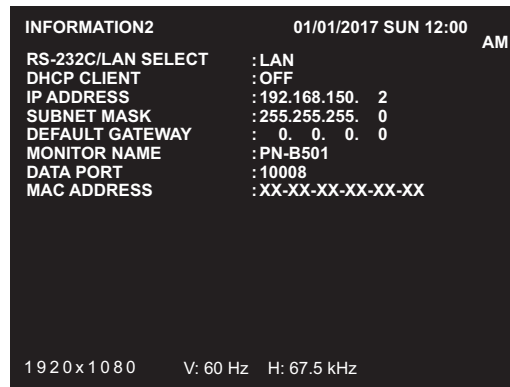
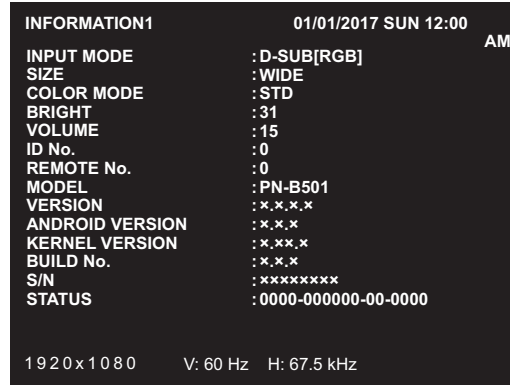

The display changes from INFORMATION1 → INFORMATION2 → INFORMATION3 → clear display, and so on every time you press this button.

- INFORMATION3 shows the information when you have used the expansion slot to expand the functions.
- The display disappears automatically after about 15 seconds.

7. FUNCTION

Use this to display the FUNCTION menu. (See pages 33 and 34.)

8. ENTER

Confirms the setting.

9. FREEZE

This is not used with this monitor.

10. Buttons for APPLICATION mode

This is used in APPLICATION mode. For details, see the Software Guide.

When the input mode is set to a mode other than APPLICATION mode, you can change the input mode to APPLICATION mode with the CONTENT MENU button.

Basic Operation

11. ID SET

Set a number on the remote control unit. (See page 32.)

12. OPTION

Switch the input mode to OPTION when you have used the expansion slot to expand the functions.

13. DP (DisplayPort)

Switch the input mode to DisplayPort.

14. SIZE (Screen size selection)

The menu is displayed.

Press the ▲ or ▼ button to select the screen size. (See page 21.)

15. PIP/PbyP

Each time you press the button, PIP MODES switches in the following order: OFF → PIP → PbyP → OFF. (See page 30.)

16. BRIGHT +/- (Brightness adjustment)

Pressing + or - displays the BRIGHT menu.

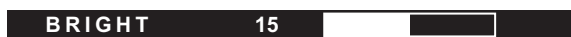

Press + or - to adjust the brightness.

* If you do not press any buttons for about 4 seconds, the BRIGHT menu automatically disappears.

17. INPUT (Input mode selection)

The menu is displayed. Press the ▲ or ▼ button to select the input mode, and press the ENTER button to enter.

In APPLICATION mode, you can use Android applications.

For details of APPLICATION mode, see the Software Guide.

* You can change the input mode by pressing the INPUT button of the monitor.

Input mode	Video	Audio
APPLICATION*1	APPLICATION	APPLICATION
DisplayPort	DisplayPort input terminal	*4
HDMI1	HDMI1 input terminal	
HDMI2	HDMI2 input terminal	
D-SUB[RGB]	D-sub input terminal*3	Audio input terminal
D-SUB[COMPONENT]		
OPTION*2	Expansion slot	*4

*1 When the input mode is set to a mode other than APPLICATION mode, you can change the input mode to APPLICATION mode with the CONTENT MENU button.

*2 This is displayed when you have used the expansion slot to expand the functions.

*3 Select the input mode to be used for D-SUB of INPUT SELECT. (See page 26.)

*4 Select the terminal for AUDIO SELECT which is used for audio input. (See page 26.)

18. MENU

Displays and turns off the menu screen. (See page 22.)

19. Cursor

These buttons are used to perform operations such as selecting items, changing adjustment values, and moving the cursor.

20. RETURN

Returns to the previous screen.

■Switching the screen size

Even when the screen size is changed, the display may remain the same depending on the input signal.

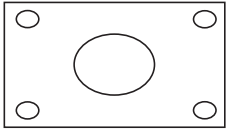
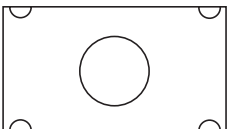
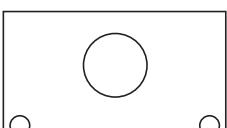
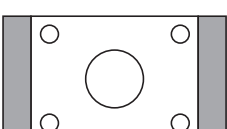
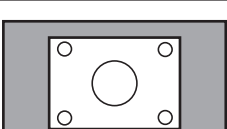
WIDE		Displays image so it fills the entire screen.
ZOOM 1		The image is enlarged to fill the entire screen without changing the aspect ratio. The edges of the image may be cut off.
ZOOM 2		Use this size if ZOOM 1 cuts off the subtitles.
NORMAL		Displays the image so it fills the screen without changing the aspect ratio.
Dot by Dot		Displays the dots of the input signals as the corresponding dots on the screen.

TIPS

- Using this monitor's screen-size switching to compress or expand the screen for commercial or public viewing in establishments like cafes or hotels may infringe on the rights of the creators, as protected by Copyright Law, so please be careful.
- When "Enlarge" is set, the screen size is fixed to "WIDE" mode.
- When dual-screen display is selected, the screen size cannot be changed.
- The appearance of the original video may change if you select a screen size with a different aspect ratio than the original image (e.g. TV broadcast or video input from external equipment).
- When 4:3 video is viewed with the whole screen using the screen-size switching function of this monitor, the edge of the video may be lost or appear distorted. If you wish to respect the creator's intentions, set the screen size to "NORMAL".
- When playing commercial software, parts of the image (like subtitles) may be cropped. In this case select the optimal screen size using the screen-size switching function of this monitor. With some software, there may be noise or distortion at the edges of the screen. This is due to the characteristics of the software, and is not a malfunction.
- Depending on the original image size, black bands may remain at the edges of the screen.

Menu Items

Displaying the menu screen

Video adjustment and settings of various functions are enabled. This section describes how to use the menu items. See page 23 for details of each menu items.

Caution

- Do not turn the main power switch off while the menu items are being displayed. Doing so may initialize the settings.

TIPS

- Also check the time setting, network settings, and other settings in the Software Guide.

Example of operation

(Adjusting CONTRAST in the PICTURE menu)

- Press the MENU button to display the menu screen.

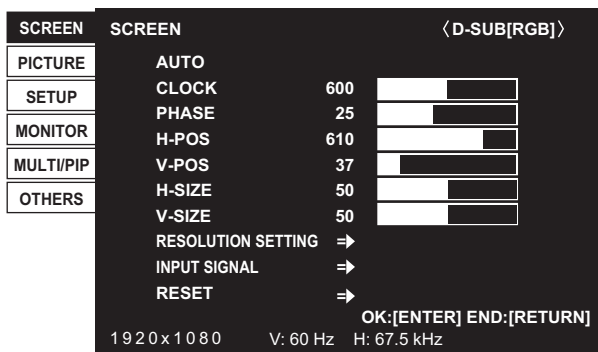

- Press the ▲ or ▼ button to select PICTURE, and press the ENTER button.

- Press the ▲ or ▼ button to select CONTRAST.

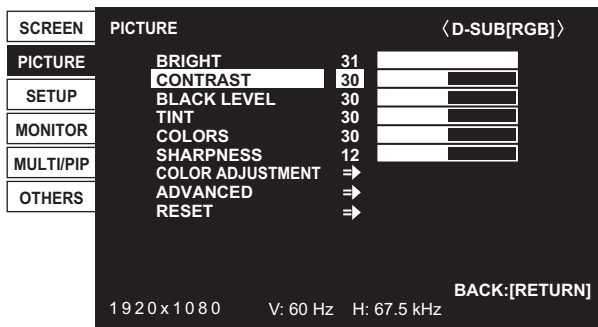

- Press the ◀ or ▶ button to adjust the setting.

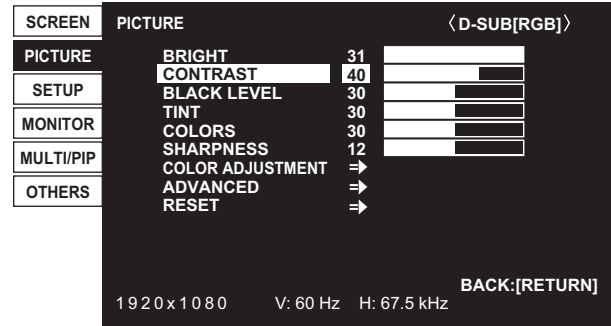

For items that have ➡, press the ENTER button to display the sub menu.

- Press the MENU button to close the menu screen.

TIPS

- The menu will differ depending on the input mode.
- The menu screen will close automatically if no operation is performed for about 15 seconds. (SCHEDULE screen will close in about 4 minutes.)

Menu screen display

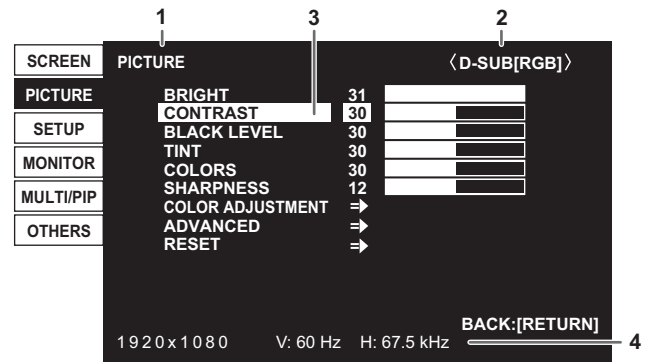

- Name of the menu
- Input mode
- An item being selected (highlighted)
- Screen resolution of input signal, and other data.

TIPS

- Items that cannot be selected appear in gray. (e.g. Function not supported by the current input signal)

Menu item details

The menu will differ depending on the input mode.

■SCREEN

AUTO (D-SUB[RGB])

The CLOCK, PHASE, H-POS, and V-POS are automatically adjusted.

Pressing the ENTER button performs adjustment. Use this automatic adjustment when you use the D-SUB[RGB] to display a computer screen for the first time or when you change the setting of the computer. (See page 32.)

CLOCK (D-SUB[RGB])

Adjusts frequency for sampling clock for applicable video.

Adjust when there is flickering in the form of vertical stripes.

When using the adjustment pattern (see page 32), make adjustments so that no vertical stripe noise appears in it.

PHASE (D-SUB[RGB])

Adjusts sampling clock phase for applicable video. Useful when small characters appear with low contrast and/or there are flickers at corners. When using the adjustment pattern (see page 32), make adjustments so that no horizontal stripe noise appears in it.

* Adjustments to PHASE should be made only after CLOCK has been correctly set.

H-POS (D-SUB[RGB])

Adjust the horizontal position of the image.

V-POS (D-SUB[RGB])

Adjust the vertical position of the image.

H-SIZE (D-SUB[RGB])

Adjust the horizontal size of the image.

V-SIZE (D-SUB[RGB])

Adjust the vertical size of the image.

RESOLUTION SETTING (D-SUB[RGB])

H-RESOLUTION

Sets proper horizontal resolution when the resolution of input signals is not recognized properly.

(Adjustment may be impossible with some signals.)

V-RESOLUTION

Sets proper vertical resolution when the resolution of input signals is not recognized properly.

(Adjustment may be impossible with some signals.)

INPUT SIGNAL (D-SUB[RGB])

If a computer connected to the D-SUB[RGB] outputs any of the following resolutions, make a selection from the following options.

480 LINES AUTO, 640x480 or 848x480

768 LINES AUTO, 1024x768, 1280x768 or 1360x768

1050 LINES 1400x1050 or 1680x1050

ZOOM2 SPECIAL SETTING (See page 30.)

RESET

Resets the values of the SCREEN menu items to the factory default settings.

Select ON and then press the ENTER button.

Menu Items

■ PICTURE

BRIGHT

Adjusts the backlight brightness.

CONTRAST

Adjusts the difference between the bright and dark portions of the image.

BLACK LEVEL

Adjusts the entire brightness of the video signals.

TINT

Adjusts the hue. Selecting + changes the color towards green, and selecting - changes it towards magenta.

COLORS

Adjusts the color intensity.

SHARPNESS

Adjusts the sharpness of the image.

COLOR ADJUSTMENT

COLOR MODE

Changes the color mode on the screen. The color mode on the screen can also be changed using a remote control unit. (See page 19 for details.)

* sRGB cannot be used when input mode is D-SUB[COMPONENT].

WHITE BALANCE

THRU Displays the input signal level as is.

PRESET Selects the color temperature using PRESET.

USER Adjusts R-/G-/B-CONTRAST and R-/G-/B-OFFSET respectively using USER.

PRESET

Selects the color temperature when the WHITE BALANCE is set to PRESET.

The setting values are shown for reference. The color temperature of the screen varies over time. This function is not intended to keep the color temperature constant.

USER

Adjusts each item when the WHITE BALANCE is set to USER.

R-CONTRAST.... Adjusts bright-toned red component.

G-CONTRAST ... Adjusts bright-toned green component.

B-CONTRAST.... Adjusts bright-toned blue component.

R-OFFSET Adjusts dark-toned red component.

G-OFFSET Adjusts dark-toned green component.

B-OFFSET Adjusts dark-toned blue component.

COPY TO USER

Copies the value of white set for PRESET to the USER setting.

Select ON and then press the ENTER button.

(In the case other than white, color tone may differ from the PRESET.)

GAMMA

Selects the gamma.

C.M.S.-HUE

Adjusts color tone with 6 colors of R (red), Y (yellow), G (green), C (cyan), B (blue), and M (magenta).

C.M.S.-SATURATION

Adjusts color vividness with 6 colors of R (red), Y (yellow), G (green), C (cyan), B (blue), and M (magenta).

ADVANCED**AUTO (D-SUB[RGB])**

The ANALOG GAIN and ANALOG OFFSET are automatically adjusted.

When a video signal is input, press the ENTER button to perform adjustment.

ANALOG GAIN (D-SUB[RGB])

Adjusts the bright portions of the video input signal.

ANALOG OFFSET (D-SUB[RGB])

Adjusts the dark portions of the video input signal.

NR

Reduce the image noise.

Setting a higher level reduces more noise. However, it may cause blurring on an image.

RGB INPUT RANGE (DisplayPort/HDMI/OPTION)

Sets the RGB input signal range.

When using HDMI, DisplayPort or OPTION set to AUTO, the RGB input signal range is detected automatically. Use AUTO normally.

If the RGB input signal range cannot be set appropriately even when using AUTO, set according to the image. When the setting is different, images will be displayed with washed out blacks and compressed gradients.

DISPLAY COLOR PATTERN

Displays a color pattern. Can be displayed while the menu screen is displayed, so you can refer to the pattern while adjusting the image. When WHITE, RED, GREEN, or BLUE is displayed, you can set the level in the range of 0 to 255.

OFFNo pattern display.

WHITE.....White single color pattern display.

RED.....Red single color pattern display.

GREENGreen single color pattern display.

BLUE.....Blue single color pattern display.

USERRed/green/blue mixed color pattern display. When USER is selected, set each color's level.

RESET

Resets the values of the PICTURE menu items to the factory default settings.

Select ON and then press the ENTER button.

Menu Items

■SETUP

DATE/TIME SETTING

Display the date and time.

When select SET, input mode change to APPLICATION, and you can set the date and time.

When APPLICATION SETTING is set to OFF, SET does not appear. Set in the displayed screen.

DATE/TIME FORMAT

Sets the date/time display format.

SCHEDULE (See page 31.)

You can turn the power on/off and change the screen brightness at a specified time.

LANGUAGE

Sets the display language for the menu screen.

INPUT SELECT

D-SUB

Select the input mode to be used in D-sub input terminal.

HDMI AUTO VIEW

When ON is selected, the screen size is adjusted automatically according to the screen size control signal included in the video signal input from the HDMI1 and HDMI2 input terminals or the expansion slot (when the expansion function is used).

HOT PLUG CONTROL

Sets whether to use hot plug control for the HDMI1 and HDMI2 input terminals and the expansion slot (when the expansion function is used).

DisplayPort SETTING

Use MODE1 normally.

If video is not displayed correctly when the DisplayPort input terminal is used, set to MODE2.

AUDIO SELECT

Selects the terminal used to input audio signals in each input mode.

AUDIO OPTION

AUDIO OUTPUT

Sets the volume of sound output from the audio output terminal.

VARIABLE1..... You can adjust the volume from the speakers of this monitor and the audio output terminal simultaneously by using VOLUME.

VARIABLE2..... You can adjust the volume from the audio output terminal by using VOLUME.
Sound will not be output from the speakers of this monitor.

START INPUT MODE

You can set the input mode that will be in effect when the power is turned on.

When this is set to LAST INPUT MODE, the input mode when the power was last turned off will appear.

COMMUNICATION SETTING

RS-232C/LAN SELECT

Selects the method with which to control the monitor from the computer.

BAUD RATE

Selects the communication speed used for RS-232C communication.

ID SETTING

ID No. SET

Assigns ID numbers to monitors connected in a daisy chain (see page 35), using the RS-232 cables.

The numbers 1 to 255 are available for ID numbers.

If "0" is set, the system regards this as the state where no ID number is set.

REMOTE No.

Sets the number of the remote control unit. (See page 32.)

■MONITOR**PORTRAIT/LANDSCAPE INSTALL**

LANDSCAPELandscape orientation

PORTRAITPortrait orientation

HORIZONTAL INSTALLATION

OFFPortrait/landscape installation.

FACE UP The display screen faces up.

FACE DOWN..... The display screen faces down.

ROTATE 180°

If video is upside down when the monitor is installed in portrait orientation, you can rotate the video 180 degrees.

Interlaced signals may not be displayed properly.

OSD H-POSITION

Adjusts the horizontal display position of menu screen.

OSD V-POSITION

Adjusts the vertical display position of menu screen.

POWER SAVE MODE

When OFF is selected, startup time from standby mode is reduced. Note, however, that more power will be consumed in standby mode. Android continues to run in standby mode.

When ON is selected, current consumption is reduced while the monitor is in standby mode. Android is also shut down. Note, however, that the startup time from standby mode becomes longer.

If set to ON, certain RS-232C commands and LAN control cannot be used in standby mode. (See pages 35 and 43.)

OFF IF NO OPERATION

Determines whether or not to set the monitor to go into standby mode when there is no operation from the remote control unit or RS-232C commands.

When the setting is ON, set the time until standby mode is entered in TIME.

POWER ON DELAY

When ON is set, you can delay the screen display after the monitor is turned on.

When ON is selected, set the delay time with INTERVAL (interval can be set up to 60 seconds in units of 1 second).

When this function is activated, the power LED flashes (at approx. 0.5 second interval) in green.

SELF ADJUST

On a D-SUB[RGB] screen, specify whether to perform screen adjustment automatically or not.

When ON is selected, the screen is automatically adjusted when the timing of input signals changes and other cases.

“ADJUSTING” appears on the screen during the adjustment.

If SELF ADJUST is set to ON, set the time it takes to start the SELF ADJUST function in START TIMING.

For images with black edges, etc., depending on the signal, adjustment may not be possible. In this case select OFF. (Perform manual adjustment of the screen.)

■MULTI/PIP

MULTI

ENLARGE (See page 30.)

Sets whether or not to use the enlarge function.

ADVANCED (ENLARGE)

ENLARGE H / ENLARGE V

.....Sets the number of screen splits (number of monitors) in the horizontal/vertical direction used for the enlargement.

ENLARGE-POS

.....Specify the split screen to be displayed when the enlargement function is used.

H-POS / V-POS

.....Adjust the horizontal/vertical position of the enlarged screen.

BEZEL ADJUST

Sets whether or not to use the frame correction function.

ADVANCED (BEZEL ADJUST)

BEZEL (TOP) / BEZEL (BOTTOM) / BEZEL (RIGHT) / BEZEL (LEFT)

.....Sets the frame width of the display.

PIP/PbyP

PIP MODES

Sets the display method.

OFF Displays one screen.

PIP Displays a sub screen inside a main screen.

PbyP..... Displays a main screen and a sub screen in a line.

PIP SIZE

Sets the size of the sub screen in PIP mode.

PIP H-POS

Adjusts the horizontal position of the sub screen in PIP mode.

PIP V-POS

Adjusts the vertical position of the sub screen in PIP mode.

PIP BLEND

In PIP mode, use this menu item to display the sub screen transparently.

PIP SOURCE

Selects the input signal of the sub screen in PIP or PbyP mode.

SOUND CHANGE

Sets the sound which is output in PIP or PbyP mode.

MAIN POS

Sets the position of the main screen in PbyP mode.

■ OTHERS**POWER MANAGEMENT**

POWER MANAGEMENT determines whether or not to switch modes from no signal to the input signal waiting mode.

CONNECT AUTO INPUT SELECT

Sets whether the input into the input terminal automatically changes when a video signal is input into that terminal. The input via the expansion slot is ignored.

(With some input signals, the input may not change.)

NO SIGNAL AUTO INPUT SEL.

Specify whether to change inputs automatically. When ON is selected and no signal is present in the selected input mode, the monitor automatically changes the selected mode to another mode where a video signal is present.

When there are video signals in multiple input modes, switching takes place according to the order of priority set in AUTO INPUT SELECT PRIORITY.

AUTO INPUT SELECT PRIORITY

Sets the order of input terminal priority for NO SIGNAL AUTO INPUT SEL..

When an option that supports this function is connected to the expansion slot, you can set the order in OPTION.

(If the option does not support this function, "OPTION" will not appear.)

Input does not change automatically for terminals without a priority setting.

LOGO SCREEN

Sets whether or not to display the logo screen.

SCAN MODE (HDMI1/HDMI2/D-SUB[COMPONENT]/OPTION)

Sets the scan mode used for video input.

MODE1..... Over-scan display.

MODE2..... Under-scan display.

MODE3..... Under-scan display when the input signal is 1080i/p. Otherwise, over-scan display.

* Even when MODE1 is selected, under-scan display is used when the input signal is 1080i/p and the screen size is Dot by Dot.

VOLUME

Adjusts the volume.

MUTE AUDIO

Temporarily mutes the audio.

BACKLIGHT OFF

When set to ON, the backlight turns off. Audio does not turn off.

TIPS

- When WHITE BALANCE is set to THRU, BLACK LEVEL, CONTRAST, TINT, COLORS, GAMMA, PRESET, USER, C.M.S.-HUE, C.M.S.-SATURATION and COPY TO USER cannot be set.
- If COLOR MODE is set to sRGB, the following items cannot be set.
WHITE BALANCE, PRESET, USER, COPY TO USER, and GAMMA
- When the COLOR MODE is set to VIVID or HIGH ILLUMINANCE, GAMMA cannot be adjusted.
- CONNECT AUTO INPUT SELECT and NO SIGNAL AUTO INPUT SEL. do not work for the signals of D-SUB[COMPONENT].

■Dual-screen display

You can display two screens simultaneously. Set this function with PIP MODES of PIP/PbyP in the MULTI/PIP menu. Or, press the PIP/PbyP button, and select the mode.

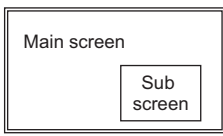
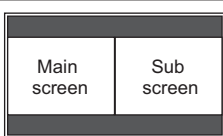
PIP		A sub screen is displayed inside a main screen.
PbyP		A main screen and a sub screen are displayed in a line.

- * The currently selected input signal is displayed on the main screen.
- * The following combinations are available for display:
 - DisplayPort - HDMI1 or HDMI2
 - DisplayPort - D-SUB[RGB]
 - DisplayPort - D-SUB[COMPONENT]
 - DisplayPort - OPTION
 - DisplayPort - APPLICATION
 - HDMI1 - HDMI2
 - HDMI1 or HDMI2 - D-SUB[RGB]
 - HDMI1 or HDMI2 - D-SUB[COMPONENT]
 - HDMI1 or HDMI2 - APPLICATION
 - HDMI2 - OPTION
 - D-SUB[RGB] or D-SUB[COMPONENT] - OPTION
 - D-SUB[RGB] or D-SUB[COMPONENT] - APPLICATION

TIPS

- You might infringe on a copyright of the author which is protected by copyright law when you display the images of the computer screen and television/VCR simultaneously for profit-making or to show the image to the public.
- In PIP, the screen size for dual-screen display is the same as the size of the main screen for single-screen display. In PbyP, the screen size for dual-screen display is the same as the sizes of the main screen and sub-screen for single-screen display. In Dot by Dot, the screen size for dual-screen display is NORMAL except when it is set as the PIP main screen.
- When dual-screen display is selected, the CONNECT AUTO INPUT SELECT function and NO SIGNAL AUTO INPUT SEL. function are disabled.
- When dual-screen display is selected and an interlaced signal (1080i, 480i) is input to the main or sub screen, the image is not displayed properly.
- When ROTATE 180° is set to ON, you cannot set PIP MODES to PIP or PbyP.

■Enlarge

- You can align several monitors and integrate them into a single large screen to display.
- Up to 5 monitors can be aligned in both the horizontal and vertical directions.
- Each monitor displays enlarged views of separated images.

(Example)
Horizontal direction: 2 monitors
Vertical direction: 2 monitors

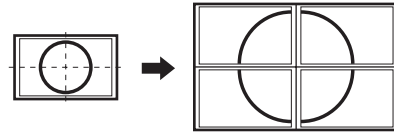

Horizontal direction: 3 monitors
Vertical direction: 2 monitors

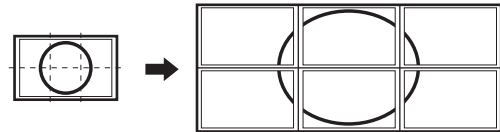

Setting procedure

Set using MULTI in the MULTI/PIP menu.

1. Set **ENLARGE** to **ON**.
2. Select **ADVANCED (ENLARGE)**.
3. Set the number of monitors aligned in the horizontal direction in **ENLARGE H**.
4. Set the number of monitors aligned in the vertical direction in **ENLARGE V**.
5. Set the section of the separated image to be displayed on each monitor in **ENLARGE-POS**.
 - 1) Press the **ENTER** button.
 - 2) Press the **▲, ▼, ◀** or **▶** button to select position, then press **MENU** button.

TIPS

- When Enlarge is used, the CONNECT AUTO INPUT SELECT function and NO SIGNAL AUTO INPUT SEL. function are disabled.
- When Enlarge is used, the HDMI AUTO VIEW function is disabled.

■ZOOM2 SPECIAL SETTING

If you connect a laptop computer with any of the following screen resolutions and black bands appear around the screen, set ZOOM2 SPECIAL SETTING of INPUT SIGNAL on the SCREEN menu to ON and then select ZOOM2 in the SIZE setting.

This displays the area inside the black band.

Laptop computer resolution	Corresponding signal*1
1280x800	1280x1024, 1280x960, 1400x1050*2
1280x600	1280x720
1024x600	1024x768

*1: This setting is effective only when the screen resolution, including the black band, is one of the resolutions listed above.

*2: Use the automatic screen adjustment.

■ SCHEDULE

You can set the time to switch the monitor on and off.
Set this function with SCHEDULE in the SETUP menu. (See page 26.)

SCHEDULE						<D-SUB[RGB]>
No.	(2) POWER	(3) DAY OF THE WEEK	(4) TIME	(5) INPUT	(6) BRIGHT	
1	-	-	-	-	-	-
2	-	-	-	-	-	-
3	-	-	-	-	-	-
4	-	-	-	-	-	-
5	-	-	-	-	-	-
6	-	-	-	-	-	-
7	-	-	-	-	-	-
8	-	-	-	-	-	-

OK:[ENTER] CANCEL:[RETURN]
1920x1080 V: 60 Hz H: 67.5 kHz

- Press the ▲ or ▼ button to select the SCHEDULE number, and press the ► button.
- Set the SCHEDULE. (See the description below.)
Press the ◀ or ▶ button to select items, and press the ▲ or ▼ button to change the setting.
- Press the ENTER button.
SCHEDULE becomes effective.

(1)

- : SCHEDULE effective
- : SCHEDULE not effective

(2) POWER

ON: Switches the monitor on at the specified time.
OFF: Switches the monitor off at the specified time and puts the monitor in standby mode.
RBT: Restart the Android system of APPLICATION mode at the specified time.

(3) DAY OF THE WEEK

Specifies the day of the week to execute the SCHEDULE.
0: ONLY ONCE
Executes the SCHEDULE once on the specified day.
Specify the day of the week to execute the SCHEDULE.
1: EVERY WEEK
Executes the SCHEDULE on the specified day of the week every week. Specify the day of the week to execute the SCHEDULE.
Periodic setting such as "Monday through Friday" is also possible.
2: EVERY DAY
Executes the SCHEDULE every day regardless of the day of the week.

(4) TIME

Specifies the time to execute the SCHEDULE.
Set the time on a 12-hour basis. (Factory default)
Can be entered as 24-hour time using the TIME setting in DATE/TIME FORMAT.

(5) INPUT

Specifies the input mode at power-on. If you don't specify this the input active at the last power-off will appear.
When START INPUT MODE is set to a value other than LAST INPUT MODE, the input mode configured for START INPUT MODE will be set.
Input modes displayed on D-SUB will depend upon the INPUT SELECT settings.

(6) BRIGHT

Sets the brightness when changing the screen brightness at a specified time.

! Caution

- Do not switch off the main power after setting the SCHEDULE.
- Specify the correct date and time. (See page 26.)
SCHEDULE does not function unless the date and time are specified.
- Check regularly that the set date and time are correct.
- When a temperature abnormality occurs and the backlight brightness is reduced, the brightness is not changed even if a schedule set to BRIGHT is executed.

TIPS

- Up to 8 SCHEDULE items can be registered.
- Setting the SCHEDULE flashes the power LED alternately in red and orange in standby mode.
- A SCHEDULE that has a large number has precedence over that of a small number when schedules overlap.
- A SCHEDULE is set by factory default in this monitor that restarts the Android system at 3:00 AM.

■About remote control numbers

If there is another monitor nearby, you can change the remote control number to prevent the other monitor from being operated by the remote control unit.

Set the same number in the monitor and in the remote control unit.

TIPS

- You can set remote control numbers to values from 0 to 9.
- When the remote control unit batteries become exhausted and when you replace the batteries, the number on the remote control unit may be reset to 0.

Changing the remote control number on the monitor

Use REMOTE No. on the SETUP menu to set the number. (See page 26.)

1. Use the ◀ or ▶ button to select the remote control number.
2. Select ON and press the ENTER button.
The remote control number is set on the monitor.

Changing the remote control number on the remote control unit

1. While holding down the ID SET button, hold down the number that corresponds to the remote control number set on the monitor for 5 seconds or more, and then release these buttons.

The remote control number is set on the remote control unit.

Checking the remote controller number

1. Press the INFORMATION button to display INFORMATION1.
2. Check that REMOTE No. is the remote control number that you have set in the above procedure.
3. Press the RETURN button to close the monitor INFORMATION screen.

TIPS

- If the remote control numbers on the monitor and remote control unit are different, they will both be displayed on INFORMATION1. On this screen, you can press the ENTER button to match the number on the monitor with the number on the remote control unit.
- Even if the remote control numbers are different, you can use the remote control unit to display the INFORMATION screen.

Adjustments for computer screen display

■Automatic adjustment

When you use the D-SUB[RGB] to display a computer screen for the first time, or when you change the setting of the computer, use the automatic screen adjustment.

1. Switch the input to D-SUB[RGB] and display the adjustment pattern. (See the description below.)
2. Press the MENU button and use the ▲ or ▼ button to display the SCREEN menu.
3. Press the ENTER button and select "AUTO".
4. Press the ENTER button.
The automatic adjustment is complete in several seconds.
5. Press the MENU button to close the menu screen.

TIPS

- If the screen cannot be adjusted properly with one automatic adjustment, repeat the automatic adjustment two or three times. Try manual adjustment if necessary.

■Screen display for adjustment

Before making adjustments in the SCREEN menu or PICTURE menu, display an image to brighten the entire screen. If you are using a Windows computer, use the adjustment pattern on the supplied CD-ROM.

Opening the adjustment pattern

The following example is performed in Windows 7.

1. Load the supplied CD-ROM into the computer's CD-ROM drive.
2. Open [CD Drive] in [Computer].
3. Double-click [Adj_uty.exe].

The adjustment pattern will appear.

Adjust the screen automatically or manually.

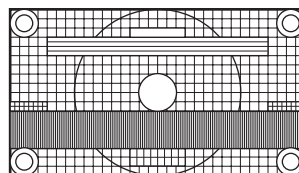

4. When adjustment is finished, press the [Esc] on the computer's keyboard to quit the adjustment program.
5. Eject the CD-ROM from the CD-ROM drive.

TIPS

- If the display mode on the computer you are using is 65000 colors, the color levels in the color pattern may appear differently or grayscale may appear to be colored. (This is due to the specifications of the input signal and is not a malfunction.)

Initialization (Reset)/Functional Restriction Setting (FUNCTION)

You can reset the settings to the factory default settings or restrict operations.

To initialize the APPLICATION mode settings, select “System Setting” – “Backup & reset” – “Factory data reset” on the CONTENT MENU screen of APPLICATION mode.

1. Press the FUNCTION button, and then press the MENU button within 10 seconds.

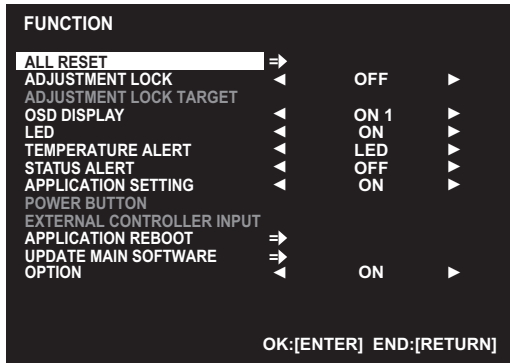

2. Select and set the items.

ALL RESET

Resets the settings to the factory default settings. Press the ENTER button, select the resetting method, and then press the ENTER button.

After initialization, turn the main power switch off and then back on.

ALL RESET 1 ...Resets all the settings to the factory default settings.
In APPLICATION mode, only the settings of the factory-installed applications are initialized.

ALL RESET 2 ...Returns all settings to the factory default settings except for the following items:
ID No. SET, REMOTE No., RS-232C/LAN SELECT, BAUD RATE, each application of APPLICATION mode

ADJUSTMENT LOCK

You can disable operations on the monitor and the remote control unit that use buttons.

OFF ... Enables operation.

ON 1 ..Disables all operations other than turning power on/off and FUNCTION.

ON 2 ..Only the FUNCTION operation is enabled.
Disables all operations other than FUNCTION (not even power on/off).

ADJUSTMENT LOCK TARGET

Sets the target to prohibit operation of with ADJUSTMENT LOCK.

REMOTE CONTROL..... Prohibits remote control operation

MONITOR BUTTONS ... Prohibits monitor button operation

BOTH..... Prohibits remote control and monitor button operation

OSD DISPLAY

Shows/hides the menu, modes and messages.

The FUNCTION screen cannot be hidden.

ON 1 Shows all menus, modes and messages.

ON 2 Hides messages automatically displayed by the display. Shows messages during operation.

OFF Hides all menus, modes and messages.

LED

Specifies whether to light the power LED.

TEMPERATURE ALERT

Selects the notification method for an abnormal temperature.

OFF Do not notify about an abnormal temperature.

OSD & LED When an abnormal temperature is detected, the power LED flashes in red and green alternately and the screen displays a message: TEMPERATURE.

LED..... When an abnormal temperature is detected, the power LED flashes in red and green alternately.

STATUS ALERT

Selects the notification method for a hardware error.

OFF Do not notify about the error.

OSD & LED When a hardware error is detected, the power LED flashes in red and the screen displays a message: STATUS [xxxx].

LED..... When a hardware error is detected, the power LED flashes in red.

APPLICATION SETTING

Set whether or not APPLICATION mode is used.

OFF Do not use APPLICATION mode. The input mode cannot be changed to APPLICATION.

ON Use APPLICATION mode.

Initialization (Reset)/Functional Restriction Setting (FUNCTION)

POWER BUTTON

Normally, leave this setting as MONITOR.

When using an optional part, if instruction appears, change the setting accordingly.

This cannot be set when APPLICATION SETTING is set to ON.

EXTERNAL CONTROLLER INPUT

Normally, you do not need to change this setting.

When using an optional part, if instruction appears, change the setting accordingly.

This cannot be set when APPLICATION SETTING is set to ON.

APPLICATION REBOOT

The Android system of APPLICATION mode restarts.

UPDATE MAIN SOFTWARE

Not normally used.

Used by service technicians when performing repairs or otherwise.

OPTION

Set whether or not the expansion slot is used.

3. Press the RETURN button to return to the normal screen.

TIPS

- When both abnormal temperature and hardware error are detected, the hardware error notification overrides.
- If TEMPERATURE ALERT or STATUS ALERT is set to OSD & LED, alert messages will appear even if the OSD DISPLAY is set to ON 2 or OFF.
- If TEMPERATURE ALERT or STATUS ALERT is set to LED or OSD & LED, the power LED lights even if the LED function is set to OFF.

Controlling the Monitor with a computer (RS-232C)

You can control this monitor from a computer via RS-232C (COM port) on the computer.

You can also connect multiple monitors via a daisy chain by using a computer. By assigning ID numbers to each monitor (see page 36), you can make input mode selection/adjustment or can check the status of a specific monitor.

TIPS

- To control the monitor via RS-232C, set RS-232C/LAN SELECT to RS-232C.
- You cannot use RS-232C and LAN control simultaneously.

Computer connection

■ One-to-one connection with a computer

Connect with RS-232 straight cable between the computer's COM port (RS-232C connector) and the RS-232C input terminal on the monitor.

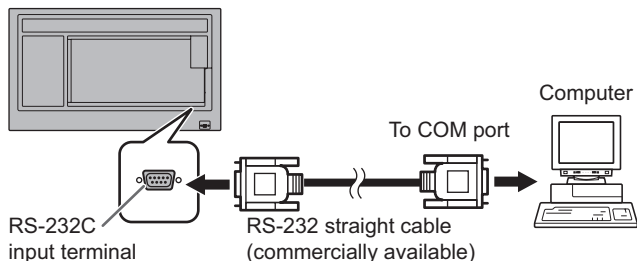

■ Daisy chain connection... **Advanced operation**

Connect with RS-232 straight cable between the computer's COM port (RS-232C connector) and the RS-232C input terminal on the first monitor.

Next, connect RS-232 straight cable to the first monitor's RS-232C output terminal and to the second monitor's RS-232C input terminal. Connect in the same way to the third and subsequent monitors.

Up to 4 monitors can be connected. (Depending on the length of the cable used and the surrounding environment.)

Second monitor

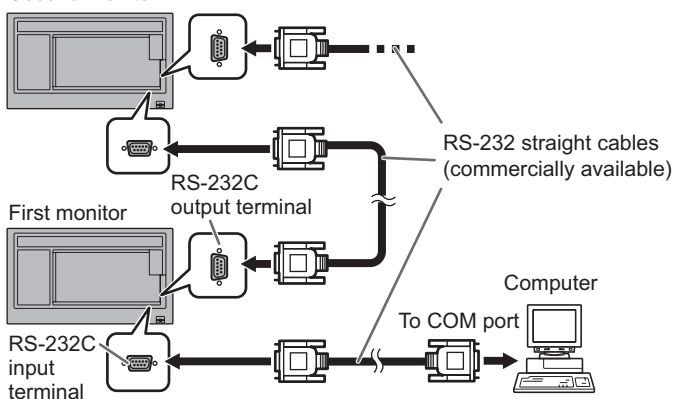

Communication conditions

Set the RS-232C communication settings on the computer to match the monitor's communication settings as follows:

Baud rate	*
Data length	8 bits
Parity bit	None

Stop bit	1 bit
Flow control	None

* Set to the same baud rate as the BAUD RATE setting of SETUP menu. (Initial setting: 38400 bps)

* When connecting multiple monitors in a daisy chain, set all monitors to the same BAUD RATE.

Communication procedure

■ Command format

When a command is sent from the computer to the monitor, the monitor operates according to the received command and sends a response message to the computer.

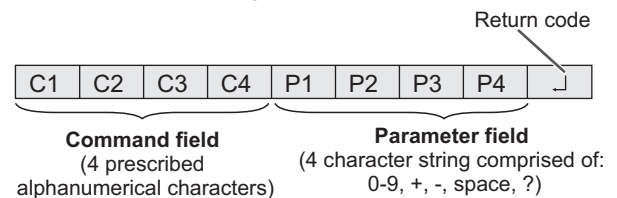

Example: VOLM0030
VOLM 30

* Be sure to input 4 characters for the parameter. Pad with spaces (" ") if necessary.

("␣" is a return code (0DH, 0AH or 0DH))

Wrong : VOLM30␣

Right : VOLM 30␣

When inputting a negative value, specify a numerical value in three digits.

Example: OFSR-127

When the parameter part is 5 or more characters, specify parameters using a specified number of characters without using spaces.

Example: MPOS010097

If a command has "R" listed for "Direction" in the "RS-232C command table" on page 39, the current value can be returned by using "?" as the parameter.

Example:

VOLM ? ? ? ? ← From computer to monitor (How much is current volume setting?).

30 ← From monitor to computer (Current volume setting: 30).

* If an ID number (see page 36) has been assigned (For example, ID number = 1).

VOLM ? ← From computer to monitor.

30 001 ← From monitor to computer.

Controlling the Monitor with a computer (RS-232C)

Response code format

When a command has been executed correctly

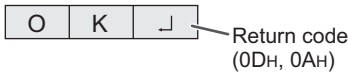

A response is returned after a command is executed.

- * If an ID number has been assigned

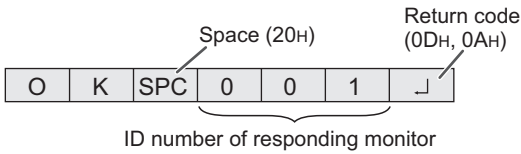

When a command has not been executed

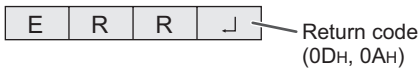

- * If an ID number has been assigned

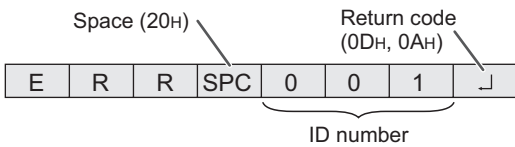

TIPS

- "ERR" is returned when there is no relevant command or when the command cannot be used in the current state of the monitor.
- If communication has not been established for reasons such as a bad connection between the computer and monitor, nothing is returned (not even ERR).
- "ERR" may be returned when a command cannot be received correctly due to interference from the surrounding environment.
Please ensure that the system or software resends the command if this occurs.
- If no monitor has been assigned the designated ID number (e.g. if the command IDSL0002 is used, but no monitor with ID number: 2 is found), no response is returned.

If execution of the command is taking some time



When the following commands are used, "WAIT" is returned. In this case, a value will be returned if you wait a while. No ID number is attached to WAIT response.

- Commands which return WAIT:
 1. When repeater control is used
 2. When an IDSL or IDLK command is used
 3. When one of the following commands is used: RSET, POWR, RPIP

After sending one of these commands, wait at least 10 seconds before sending the next command. If there is no response, resend the command.

When RS-232C/LAN SELECT is set to LAN

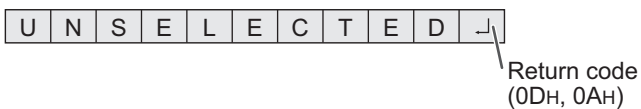

Communication interval

- To set a timeout for the command response, specify 10 seconds or longer.
When connecting multiple monitors in a daisy chain, set the timeout to at least the product of the monitor's position from the computer multiplied by 10 seconds.
Example) 3rd monitor from computer: 30 seconds or longer.
- Provide an interval of 100 ms or more between the command response and the transmission of the next command.

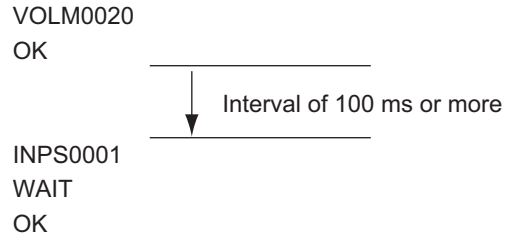

TIPS

- When executing ALL RESET, set the interval until the next command is sent to at least 30 seconds.
- When turning the power on while the POWER ON DELAY function is in use, set the interval until the next command is sent to the POWER ON DELAY period + 10 seconds or longer.

Advanced operation

This section explains commands for daisy chain connection. The basic communication procedure is the same as in the "One-to-one connection with a computer" section.

ID numbers

You can assign a unique ID number to each monitor. (See page 26.) This allows you to control a particular monitor in a daisy chain of monitors. You can assign ID numbers either from the menu screen or from the computer using RS-232 cable.

[Example]

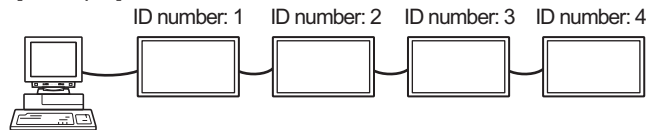

If monitors are connected as shown above, you can execute commands like "Set the volume of the monitor with ID 4 to 20".

When designating ID numbers for a set of monitors linked in a daisy chain, you should basically avoid any duplication of ID numbers.

ID numbers do not have to be assigned in ascending order starting from the computer. They can also be connected as shown below.

[Example]

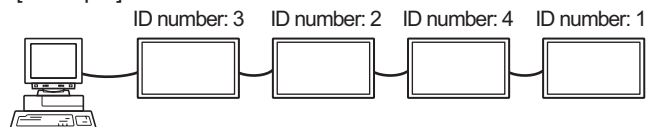

■ Commands for ID control

The command examples shown on this page assume the following connection and ID number set up.

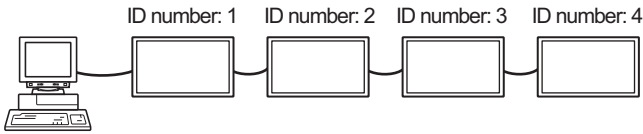

IDSTA monitor receiving this command sets its own ID number in the parameter field.

Example:

IDST0001

OK _ 001 ← The ID number of this monitor is set to 1.

TIPS

You can automatically assign ID numbers by using the IDST command with the Repeater control (see “Repeater control” on page 38).

For example, using the command “IDST001+” automatically sets the ID numbers, as shown below.

[Example]

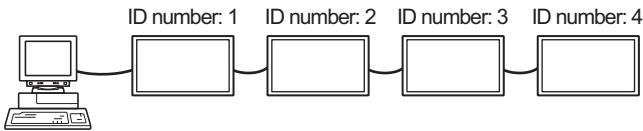

IDST001 + ← ID setting command with repeater control
WAIT

OK _ 001 ← “OK” response from ID number: 1

OK _ 002 ← “OK” response from ID number: 2

OK _ 003 ← “OK” response from ID number: 3

OK _ 004 ← “OK” response from ID number: 4 (End)

IDSLThe parameter of this command sets the ID number of the monitor. The monitor is subject to the next command.

Example:

IDSL0002 ← The next command is for the monitor with ID number: 2.

WAIT ← Searching for monitor with ID number: 2

OK _ 002 ← Found monitor with ID number: 2

VOLM0030 ← Sets volume of monitor with ID number: 2 to 30.

WAIT ← Processing

OK _ 002 ← OK response from monitor with ID number: 2

VOLM0020 ← Sets volume to 20.

OK _ 001 ← The volume of the monitor with ID number: 1 (the one directly connected to the computer) is set to 20.*

* The IDSL command is effective only once, for the immediately succeeding command.

IDLKThe parameter of this command sets the ID number of the monitor. The monitor is subject to all subsequent commands.

Example:

IDLK0002 ← Following commands are for the monitor with ID number: 2.

WAIT ← Searching for monitor with ID number: 2

OK _ 002 ← Found monitor with ID number: 2

VOLM0030 ← Sets volume of monitor with ID number: 2 to 30.*

WAIT ← Processing

OK _ 002

VOLM0020 ← Sets volume of monitor with ID number: 2 to 20.*

WAIT

OK _ 002

IDLK0000 ← Canceling fixed ID number setting

WAIT ← Canceling IDLK

OK _ 002 ← Cancellation complete

VOLM0010

OK _ 001 ← The volume of the monitor with ID number: 1 (the one directly connected to the computer) is set to 10. (IDLK is canceled.)

* The IDLK command remains effective until it is canceled, or power is shut off.

IDCK.....Provides screen display of the ID number currently assigned to a monitor, and the ID number currently set for IDLK (if any).

Example:

(After executing IDLK0002)

IDCK0000 ← (Parameter has no meaning.)

ID : 001 IDLK : 002 ← Returned response. The ID number is also displayed on the monitor screen.

IDCK000 + ← Repeater control. (If a command is used with repeater control, ID designation using IDSL or IDLK is canceled.)

WAIT

ID : 001 IDLK : 000

ID : 002 IDLK : 000

ID : 003 IDLK : 000

ID : 004 IDLK : 000

Controlling the Monitor with a computer (RS-232C)

■ Repeater control

This system has a function to allow setting of multiple monitors connected in a daisy chain using a single command. This function is called repeater control. You can use Repeater control function without assigning ID numbers.

[Example]

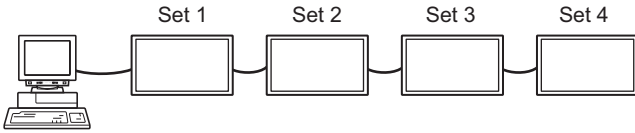

* If monitors are connected as shown above, you can execute a command like "Set all monitors' input settings to D-SUB[RGB]".

■ Repeater control command

Repeater control is achieved by setting the FOURTH CHARACTER of the parameter to "+".

Example:

```
VOLM030 + ← Sets volume of all monitors to 30.
```

In repeater control, responses are returned by all the connected monitors.

If you want to determine that a value has been returned by a specific set, assign ID numbers to each monitor in advance. When some monitors do not return their responses, the probable cause is that the monitors could not receive the command or command processing is not complete. Do not send a new command.

Example: (When 4 monitors are connected, and assigned ID numbers: 1 through 4)

```
VOLM030 +  
WAIT  
OK _ 001  
OK _ 002  
OK _ 003  
OK _ 004 ← If 4 monitors are connected in  
a chain, reliable operation can  
be ensured by sending a new  
command only after a reply  
has been returned by 4th (last)  
monitor.
```

Repeater control can also be used for reading settings.

Example:

```
VOLM ??? +  
WAIT  
10 _ 001  
20 _ 002  
30 _ 003  
30 _ 004
```

Volume settings for all monitors are returned.

TIPS

- If repeater control is used during ID designation (IDSL, IDLK), the ID designation is canceled.

RS-232C command table

How to read the command table

- Command: Command field (See page 35.)
- Direction: W When the "Parameter" is set in the parameter field (see page 35), the command functions as described under "Control/Response Contents".
 R The returned value indicated under "Reply" can be obtained by setting "????", "____?" or "???" (repeater control) in the parameter field. (See page 35.)
- Parameter: Parameter field (See page 35.)
- Reply: Response (Returned value)
- * : When POWER SAVE MODE is set to OFF:
 "●/○" : Indicates a command which can be used in standby mode or when the power is on.
 "—" : Indicates a command which can be used when the power is on. Cannot be used in standby mode.
- When POWER SAVE MODE is set to ON:
 "●" : Indicates a command which can be used in standby mode or when the power is on.
 "○/—" : Indicates a command which can be used when the power is on. Cannot be used in standby mode.

Power control/Input mode selection

Function	Command	Direction	Parameter	Reply	Control/Response contents	*
POWER CONTROL	POWR	W	0		Switches to standby mode.	
			1		Returns from standby mode.	
		R	0		Standby mode	
			1		Normal mode	
			2		Input signal waiting mode	
INPUT MODE SELECTION	INPS	W	0		Toggle change for input mode. Terminals not selected in INPUT SELECT cannot be selected.	●
			2		D-SUB[RGB] "ERR" when other than RGB is selected for D-SUB of INPUT SELECT.	
			3		D-SUB[COMPONENT] "ERR" when other than COMPONENT is selected for D-SUB of INPUT SELECT.	
			10		HDMI1	
			13		HDMI2	
			14		DisplayPort	
			21		OPTION "ERR" when nothing is attached in the expansion slot.	
			24		APPLICATION	
		R	2		D-SUB[RGB]	
			3		D-SUB[COMPONENT]	
			10		HDMI1	
			13		HDMI2	
			14		DisplayPort	
			21		OPTION	
		24		APPLICATION		

SCREEN menu

Function	Command	Direction	Parameter	Reply	Control/Response contents	*
Check the resolution (other than D-SUB[COMPONENT])	PXCK	R		-	Returns current resolution in the form of hhh, vvv.	○

Controlling the Monitor with a computer (RS-232C)

PICTURE menu

Function		Command	Direction	Parameter	Reply	Control/Response contents	*	
BRIGHT		VLMP	WR	0-31	0-31			
COLOR ADJUSTMENT	COLOR MODE	BMOD	WR	0	0	STD		
				2	2	VIVID		
				3	3	sRGB (sRGB cannot be used when input mode is D-SUB[COMPONENT].)		
				4	4	HIGH ILLUMINANCE		
	WHITE BALANCE		WHBL	WR	0-2	0-2	0:THRU, 1:PRESET, 2:USER	
	PRESET		CTMP	WR	1-28	1-28	From 1: approximately 3000K to 15: approximately 10000K (500K steps) 16: approximately 5600K, 17: approximately 9300K, 18: approximately 3200K From 19: approximately 10500K to 28: approximately 15000K (500K steps) "ERR" when WHBL is not set to 1.	
	USER	R-CONTRAST	CRTR	WR	0-256	0-256	"ERR" when WHBL is not set to 2.	
		G-CONTRAST	CRTG	WR	0-256	0-256		
		B-CONTRAST	CRTB	WR	0-256	0-256		
		R-OFFSET	OFSR	WR	-127-127	-127-127		
G-OFFSET		OFSG	WR	-127-127	-127-127			
COPY TO USER		CPTU	WR	0	0	Copies a preset value to the user setting.		
ADVANCED	RGB INPUT RANGE	INPR	WR	0-2	0-2	0: AUTO, 1: FULL, 2: LIMITED "ERR" when the input mode is D-SUB[RGB], D-SUB[COMPONENT] or APPLICATION.		

SETUP menu

Function		Command	Direction	Parameter	Reply	Control/Response contents	*
DATE/TIME SETTING		DATE	WR	YYMMDDO0MM	YYMMDDO0MM	YY: Year, MM: Month, DD: Day, OO: Hour, MM: Minute	
SCHEDULE		SC01-SC08	WR	ABCDEFFGGH	ABCDEFFGGH	Schedule of a specified number A: Schedule 0= Not effective, 1 = Effective B: Power 0 = OFF, 1 = ON, 2 = Android system restart C: Day of the week 1 0 = Only once, 1 = Every week, 2 = Every day D: Day of the week 2 0 = Sunday, 1 = Monday through 6 = Saturday, 9 = Not exist E: Day of the week 3 0 = Sunday, 1 = Monday through 6 = Saturday, 9 = Not exist F: Hour 00-23 G: Minute 00-59 H: Input 0 = Not specified, 1 = APPLICATION, 2 = DisplayPort, 3 = HDMI1, 4 = HDMI2, 5 = D-SUB, 6 = OPTION(valid when an option is attached)	
SCHEDULE BRIGHTNESS		SB01-SB08	WR	0-31	0-31	Screen brightness to change	
				99	99	Disable brightness setting	
COMMUNICATION SETTING	RS-232C/LAN SELECT	CTLS	WR	0-1	0-1	0: RS-232C, 1: LAN	
ID SETTING	ID No. SET	IDST	WR	0-255	0-255	Sets the monitor's ID number. ("0" means "no ID number".)	
	ID NO. SETTING (ONCE)	IDSL	W	1-255		Set a monitor's ID number to send a command. This ID number is only effective for the command immediately after this command.	
				0		Clears the ID number if one has been designated.	
	ID NO. SETTING (SUBSEQUENT)	IDLK	W	1-255		Set a monitor's ID number to send a command. This ID number is effective for the next and all subsequent commands after this command.	
				0		Clears the ID number if one has been designated.	
ID CHECK	IDCK	W	0	ID : xxx IDLK : yyy	Displays monitor's own ID number and the selected ID number on the screen.		
ID DISPLAY	IDDP	W	0-2		0: OFF, 1: ON, 2: ON (turns OFF after 4 sec.) (The IP address and MAC address are both displayed.)		

MONITOR menu

Function		Command	Direction	Parameter	Reply	Control/Response contents	*
PORTRAIT/LANDSCAPE INSTALL		STDR	WR	0-1	0-1	0: LANDSCAPE, 1: PORTRAIT	
HORIZONTAL INSTALLATION		MLAY	WR	0-2	0-2	0: OFF, 1: FACE UP, 2: FACE DOWN	

Controlling the Monitor with a computer (RS-232C)

MULTI/PIP menu

Function	Command	Direction	Parameter	Reply	Control/Response contents	*
ENLARGE	ENLG	WR	0-1	0-1	0: OFF, 1: ON	
ENLARGE MODE	EMHV	WR	12(21)-55	12(21)-55	1 x 2 (2 x 1) to 5 x 5 ("m x n" is expressed as "mn", where m and n are the numbers of monitors specified for the longest direction and the shortest direction respectively.)	
IMAGE POSITION (M x N)	EPHV	WR	11-55	11-55	Specifies values in the order of IMAGE POSITION IN LONGEST/ SHORTEST DIRECTION.	
BEZEL ADJUST	BZCO	WR	0-1	0-1	0: OFF, 1: ON	-
BEZEL WIDTH	TOP	BZWT	WR	0-100	0-100	
	BOTTOM	BZWB	WR	0-100	0-100	
	RIGHT	BZWR	WR	0-100	0-100	
	LEFT	BZWL	WR	0-100	0-100	
ENLARGE/IMAGE POSITION SETTING	ESHV	WR	XXYY	XXYY	XX: ENLARGE MODE (Same as EMHV), YY: IMAGE POSITION (Same as EPHV)	
PIP MODES	MWIN	WR	0-2	0-2	0: OFF, 1: PIP, 2: PbyP	
PIP SIZE	MPSZ	WR	1-64	1-64		
PIP POS	THE LONGEST DIRECTION	MHPS	WR	0-100	0-100	
	THE SHORTEST DIRECTION	MVPS	WR	0-100	0-100	
PIP POS LD+SD BATCH	MPOS	W		0-100,0-100		Specify the position in MPOSxxxxyy format. (xxx: Longer side, yyy: Shorter side position)
		R		0-100,0-100		Returns a response in (xxx,yyy) format. (xxx: Longer side, yyy: Shorter side position)
PIP SOURCE	MWIP	WR	2	2	D-SUB[RGB]	O
			3	3	D-SUB[COMPONENT]	
			10	10	HDMI1	
			13	13	HDMI2	
			14	14	DisplayPort	
			21	21	OPTION	
24	24	APPLICATION				
SOUND CHANGE	MWAD	WR	1-2	1-2	1: MAIN, 2: SUB	
RESET	RPIP	W	1	1		

Initialization/Functional Restriction Setting (FUNCTION) menu

Function	Command	Direction	Parameter	Reply	Control/Response contents	*
ALL RESET	RSET	W	0-1		0: ALL RESET 1, 1: ALL RESET 2	-
ADJUSTMENT LOCK	ALCK	WR	0-2	0-2	0: OFF, 1:ON 1, 2:ON 2	●
ADJUSTMENT LOCK TARGET	ALTG	WR	0-2	0-2	0: REMOTE CONTROL, 1: MONITOR BUTTONS, 2: BOTH	
APPLICATION REBOOT	AARB	W	1			-

Controlling the Monitor with a computer (RS-232C)

Others

Function	Command	Direction	Parameter	Reply	Control/Response contents	*	
SIZE (Screen size selection)	WIDE	WR	1-5	1-5	1: WIDE, 2: NORMAL, 3: Dot by Dot, 4: ZOOM1, 5: ZOOM2	○	
VOLUME	VOLM	WR	0-31	0-31			
MUTE AUDIO	MUTE	WR	0-1	0-1	0: OFF, 1: ON	-	
INFORMATION	Model	INF1	R	Value			
	Serial no.	SRNO	R	Value			
Temperature sensor	DSTA	R		0	Internal temperature normal		
				1	Internal temperature abnormal has occurred and the monitor is in standby mode	●	
				2	Internal temperature abnormal occurred (To delete the information of temperature abnormal, turn off the main power.)		
				3	Internal temperature abnormal has occurred and backlight brightness is dimmed		
				4	Temperature sensor abnormal		
Temperature acquisition	ERRT	R		Value	Returns the temperature at the temperature sensors. Indicates a temperature sensor abnormality when "126" is returned.	○	
Cause of last standby mode	STCA	W		0	Initialization		
		R		0	No detectable error has occurred		
		1		Standby mode by POWER button or MONITOR OFF button			
		2		Main power off by the main power switch			
		3		Standby mode by RS-232C or LAN	●		
		4		Input signal waiting mode by No Signal			
		6		Standby mode by abnormal temperature			
		8		Standby mode by SCHEDULE setting			
		20		Standby mode by OFF IF NO OPERATION setting			
LAN SETUP	DHCP CLIENT	DHCP	WR	0-1	0-1	0: OFF, 1: ON * Apply the settings to this monitor by NTUP.	
	IP ADDRESS	IPAD	WR	XXXXXXXXXX	XXXXXXXXXX	X: Only number is ok. If the number is less than 3 digits, to 3 digits to fill 0. Example: 192168150001 * Apply the settings to this monitor by NTUP.	
	SUBNET MASK	SBMK	WR	XXXXXXXXXX	XXXXXXXXXX	X: Only number is ok. If the number is less than 3 digits, to 3 digits to fill 0. Example: 25525255000 * Apply the settings to this monitor by NTUP.	
	DEFAULT GATEWAY	DFGW	WR	XXXXXXXXXX	XXXXXXXXXX	X: Only number is ok. If the number is less than 3 digits, to 3 digits to fill 0. Example: 000000000000 * Apply the settings to this monitor by NTUP.	
	FTP ON/OFF select	FCHE	WR	0-1	0-1	0: FTP connection OFF, 1: FTP connection ON	
	Monitor name	MNTR	WR	XXXXXXXXXX XXXXXXXXXX	XXXXXXXXXX XXXXXXXXXX	16 characters or less; half-width alphanumeric characters, "-", and "_". (The field can be left blank, but spaces cannot be entered.)	○
	FTP Username	FUSR	WR	XXXXXXXXXX	XXXXXXXXXX	8 characters or less; half-width alphanumeric characters, "-", and "_". (The field cannot be left blank, and spaces cannot be entered.)	
	FTP Password	FPAS	WR	XXXXXXXXXX	XXXXXXXXXX	8 characters or less; half-width alphanumeric characters, "-", and "_". (The field cannot be left blank, and spaces cannot be entered.)	
	User name	USER	WR	XXXXXXXXXX	XXXXXXXXXX	8 characters or less; half-width alphanumeric characters, "-", and "_". (The field can be left blank, but spaces cannot be entered.)	
	Password	PASS	WR	XXXXXXXXXX	XXXXXXXXXX	8 characters or less; half-width alphanumeric characters, "-", and "_". (The field can be left blank, but spaces cannot be entered.)	
	Auto logout time	LOTM	WR	00000-65535	00000-65535	Set the time that display terminate a network connection automatically by minutes.	
Data port	TCPP	WR	01025-65535	01025-65535	Set the TCP port number for data communication. * Apply the settings to this monitor by NTUP.		
Reflecting LAN setting	NTUP	W	1	1	Applies the DHCP CLIENT, IP ADDRESS, SUBNET MASK, DEFAULT GATEWAY, and Data port settings to this monitor.		

Controlling the Monitor with a computer (LAN)

Your monitor can be connected to a LAN allowing you to control it from a computer on the LAN.

The connection requires a commercially available LAN cable (UTP cable, Category 5, straight through).

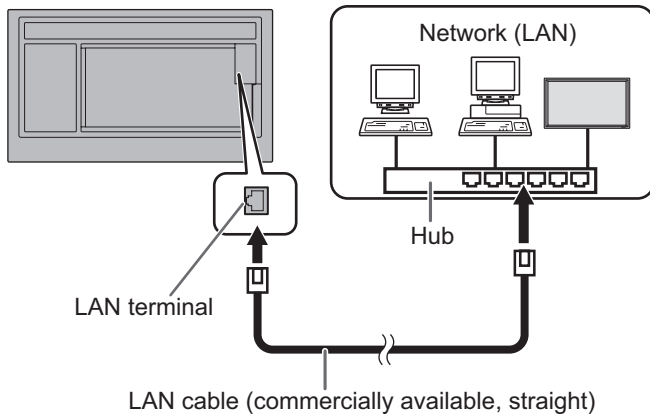

TIPS

- This monitor must be connected to a network. Configure settings required for connection to a network in "System Setting" – "Ethernet" on the CONTENT MENU screen of APPLICATION mode.
- When POWER SAVE MODE is set to ON, the control is disabled in the standby mode.
- To control the monitor via LAN, set RS-232C/LAN SELECT to LAN. (See page 26.)
- You cannot use RS-232C and LAN control simultaneously.

Command-based control

You can control the monitor using RS-232C commands (see page 39) via terminal software and other appropriate applications.

Read the manual for the terminal software for detailed instructions.

(1) Connect the computer to the monitor.

1. Specify the IP address and data port number (10008) and connect the computer to the monitor. When connection has been established successfully, [Login:] is returned as response.
2. Send the user name.
 - Send [user name] + [Enter].
 - If the user name is not set, send [Enter].
 - When the transmission is successful, [Password:] is returned as response.
3. Send the password.
 - Send [password] + [Enter].
 - If the password is not set, send [Enter].
 - When the transmission is successful, [OK Enter] is returned as response.

(2) Send commands to control the monitor.

- The commands used are the same as those for RS-232C. Refer to the communication procedure (see page 35) for operation.
- Usable commands are provided in the RS-232C command table (see page 39).

(3) Disconnect the connection with the monitor and quit the function.

1. Send [QUITEnter].
When the transmission is successful, [goodbye] is returned and the connection is disconnected.

TIPS

- Connection is automatically disconnected when the time specified in AUTO LOGOUT TIME elapses over a no-communication period.

Troubleshooting

If you are experiencing any problem with your display, before calling for service, please review the following troubleshooting tips.

There is no picture or sound.

- The power LED is off.
 - Is power supplied to this monitor?
 - Is the power cord disconnected? (See page 13.)
 - Is the main power switch off? (See page 17.)
- The power LED lights orange.
 - This monitor is in standby mode. Turn on the power. (See page 17.)
- The power LED flashes green.
 - There is no input signal.
 - Is an input mode selected that is appropriate for the input terminal to which the cable is connected? (See page 20.)
 - If any external equipment is connected, make sure the equipment is operating (playing back).

Remote control does not work.

- Are the batteries inserted with polarity (+,-) aligned? (See page 15.)
- Are the batteries exhausted?
- Point the remote control unit toward the monitor's remote control sensor. (See page 15.)
- Is the menu display hidden or is operation disabled? (See page 33.)
- Do the remote control numbers on the remote control unit and on the monitor match?
Check the numbers on INFORMATION. (See page 32.)

Sound from left and right speakers is reversed.

Sound is heard from only one side.

- Are audio cables connected properly?

There is a picture but no sound.

- Is the sound muted?
- Make sure the volume is not set to minimum.
- Are audio cables connected properly?

Unstable video.

- The signal may be incompatible.
- Try the automatic screen adjustment when D-SUB[RGB] is in use.

The video from the HDMI input terminal does not appear properly.

- Is the HDMI cable HDMI standard compliant? The monitor will not work with cables that are not standard compliant.
- Is the input signal compatible with this monitor? (See pages 47 and 48.)

The video from D-Sub input terminal does not appear correctly.

- Is the setting for D-SUB of INPUT SELECT on the SETUP menu correct? (See page 26.)
- Is the input signal compatible with this monitor? (See pages 47 and 48.)

The video from the DisplayPort does not appear properly.

- Is the DisplayPort cable DisplayPort standard compliant? The monitor will not work with cables that are not standard compliant.
- Is the input signal compatible with this monitor? (See page 47.)
- If the monitors are connected in a daisy chain, turn off the power to all the monitors connected in a daisy chain and then turn the power on again.

Control buttons do not work.

There is no picture.

- Load noises from outside may be interfering with normal operation. Turn off the main power and turn it on after waiting at least 5 seconds, and then check the operation.

The input mode changes automatically.

- When NO SIGNAL AUTO INPUT SEL. is ON and the current video signal input stops, the input mode automatically changes to the mode of an active video signal.
Consequently, the input mode may change even in the following cases:
 - When a computer enters standby mode.
 - When video play is stopped with a playback device.

Power LED flashes red.

“STATUS [xxxx]” appears in the corner of the screen.

- Hardware has a problem. Turn off the monitor and request repair from your SHARP dealer.
(When STATUS ALERT is set to OSD & LED. This varies depending on the setting.)

When “AUTO DIMMING” is displayed.

- When the internal temperature of the monitor rises excessively, the brightness of the backlight automatically decreases in order to prevent a further temperature rise. If you attempt to adjust the brightness while the monitor is in this state, “AUTO DIMMING” is displayed and you cannot change the brightness.
- Remove the cause of the excessive temperature rise.

The monitor makes a cracking sound.

- You may occasionally hear a cracking sound from the monitor. This happens when the cabinet slightly expands and contracts according to change in temperature. This does not affect the monitor's performance.

The Power LED is flashing in red and green alternately.

When “TEMPERATURE” is displayed in the corner of the screen.

- When the internal temperature of the monitor rises excessively, the brightness of the backlight decreases automatically in order to prevent high-temperature-related problems. When this occurs, “TEMPERATURE” is displayed on the screen and the Power LED flashes red and green alternately. (When TEMPERATURE ALERT is set to OSD & LED. This varies depending on the setting.)
- If the internal temperature rises further, the monitor automatically enters standby mode. (The Power LED continues flashing red and green alternately.)
- Remove the cause of the excessive temperature rise.
 - If the monitor enters standby mode due to a rise in temperature, to return to normal display, turn the power switch off and then back on again. The monitor, however, will enter standby mode again if the cause of the temperature rise is not eliminated. (See page 7.)
 - Check whether the monitor is placed at a location where a quick rise in temperature is likely. Internal temperature rises quickly if the vents on the monitor are blocked.
 - Internal temperature rises quickly if dust accumulates inside the monitor or around the vents. Remove dust if possible. Ask SHARP dealer about removing internal dust.

Specifications

■Product Specifications

Model		PN-B501	PN-B401
LCD component		50" Class [49-1/2 inch (125.73 cm) diagonal] TFT LCD	40" Class [39-1/2 inch (100.33 cm) diagonal] TFT LCD
Max. resolution	(pixels)	1920 x 1080	
Max. colors		Approx. 16.77 million colors	
Pixel pitch		0.5708 mm (H) × 0.5708 mm (V)	0.45735 mm (H) × 0.4494 mm (V)
Brightness (typical)		300 cd/m ² *1	
Contrast ratio (typical)		5000: 1	
Viewing angle		178° right/left/up/down (contrast ratio ≥ 10)	
Screen active area	inch (mm)	43-1/8 (W) x 24-1/4 (H) (1095.84 x 616.41)	34-9/16 (W) x 19-1/8 (H) (878.112 x 485.352)
Computer input signal		Analog RGB (0.7 Vp-p) [75 Ω], HDMI	
Sync signal		Horizontal/vertical separate (TTL: positive/negative)	
Plug and play		VESA DDC2B	
Power management		VESA DPMS	
Input terminals	Video	Mini D-sub 15 pin, 3 rows x 1 HDMI x 2 DisplayPort x 1	
	Serial (RS-232C)	D-sub 9 pin x 1	
	Audio	3.5 mm mini stereo jack x 1	
Output terminals	Video	DisplayPort x 1	
	Serial (RS-232C)	D-sub 9 pin x 1	
	Audio	3.5 mm mini stereo jack x 1	
Android	OS	Android 4.4	
	CPU	Quad-Core (ARM Cortex-A17 processor)	
	Memory	2GB	
	Storage	8GB	
	SD card slot	SD/SDHC x 1	
	USB port	USB (USB 2.0 compliant) x 3	
LAN terminal	10 BASE-T/100 BASE-TX/1000 BASE-T		
Expansion slot		12 V, 2.5 A (power supplied when expanding the functions with an optional part)	
Speaker output		7 W + 7 W	
Power requirement		AC 100 - 240 V, 1.4 A, 50/60 Hz	AC 100 - 240 V, 1.1 A, 50/60 Hz
Operating temperature *2		32°F to 104°F (0°C to 40°C)	
Operating humidity		20% to 80% (no condensation)	
Power consumption (input signal waiting mode / standby mode *3)		120 W (9 W / 9 W)	92 W (9 W / 9 W)
Dimensions (excluding protrusions)	inch (mm)	Approx. 44-3/16 (W) x 2-11/16 (D) x 25-1/2 (H) (1123 x 68 x 647)	Approx. 35-1/2 (W) x 2-5/8 (D) x 20-3/16 (H) (902 x 66 x 513)
Weight	lbs. (kg)	Approx. 49 (22)	Approx. 34 (15)

*1 Brightness will depend on input mode and other picture settings. Brightness level will decrease over time. Due to the nature of the equipment, it is not possible to precisely maintain a constant level of brightness.

*2 When using this monitor laying flat on a surface (when the monitor is tilted more than 20 degrees upward or downward from the perpendicular in relation to a level surface), use this monitor at a temperature between 32°F (0°C) to 86°F (30°C). Temperature condition may change when using the monitor together with the optional equipments recommended by SHARP. In such cases, please check the temperature condition specified by the optional equipments.

*3 When POWER SAVE MODE is set to OFF, and no optional part is attached. When POWER SAVE MODE is set to ON: 0.5 W

As a part of our policy of continuous improvement, SHARP reserves the right to make design and specification changes for product improvement without prior notice. The performance specification figures indicated are nominal values of production units. There may be some deviations from these values in individual units.

Specifications

■ Dimensional Drawings

Note that the values shown are approximate values.

[PN-B501]

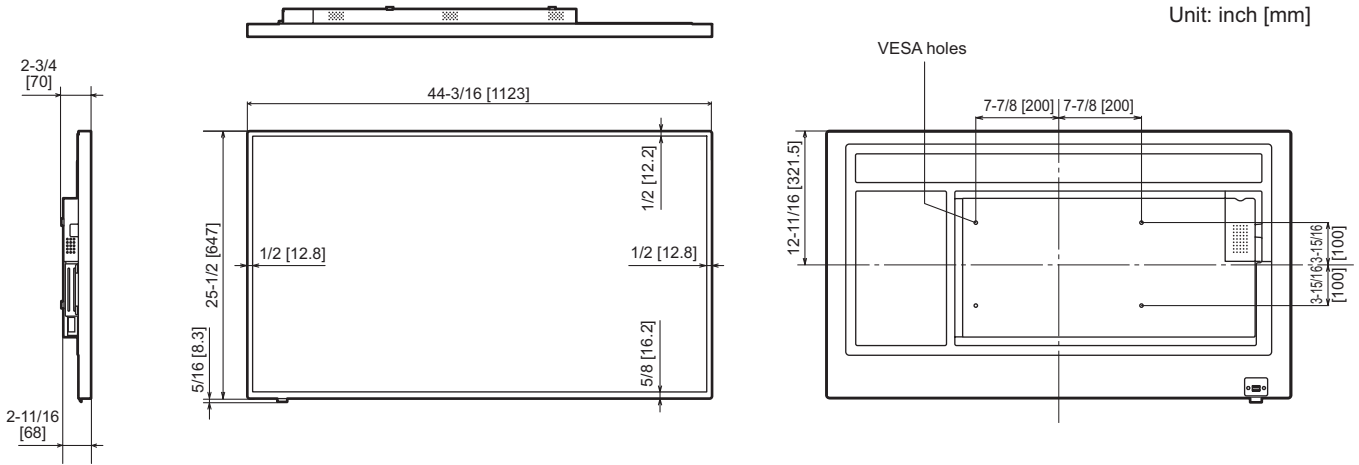

[PN-B401]

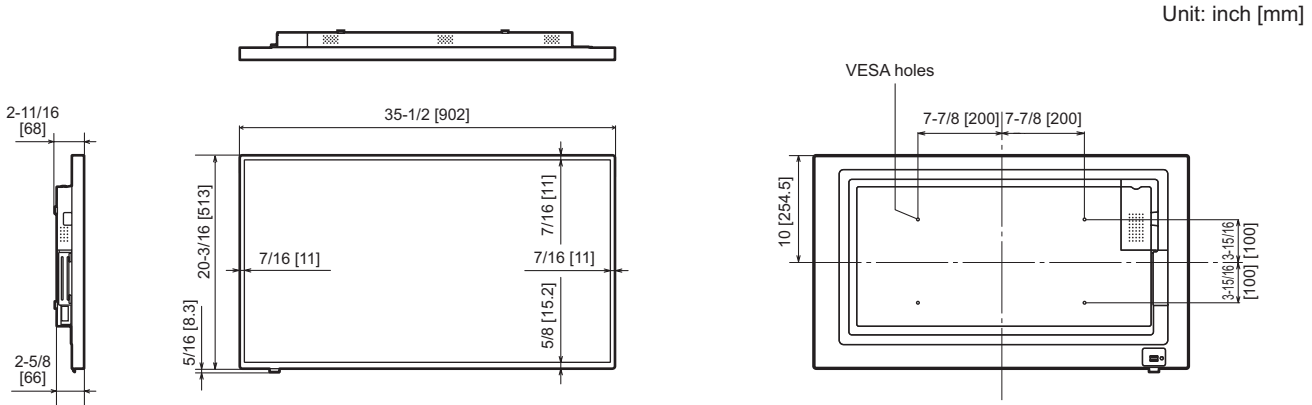

When mounting the monitor, be sure to use a wall-mount bracket that complies with the VESA-compatible mounting method. SHARP recommends using M6 screws and tighten the screws. Note that screw hole depth of the monitor is 3/8 inch (10 mm). Loose mounting may cause the product to fall, resulting in serious personal injuries as well as damage to the product. The screw and hole should come together with over 5/16 inch (8 mm) length of thread. Use a bracket which has been approved for UL1678 standard, and which can endure at least 4 times or more the weight of the monitor.

■ DDC (plug and play)

The monitor supports the VESA DDC (Display Data Channel) standard.

DDC is a signal standard for plug and play between monitors and computers. Information about resolution and other parameters is exchanged between the two. This function can be used if the computer supports DDC and it has been configured to detect plug-and-play monitors.

There are several types of DDC, depending on the communication method used. This monitor supports DDC2B.

■Power management

This monitor conforms to VESA DPMS. Both your video card and computer must support the same standard in order for the monitor's power management function to work.

DPMS: Display Power Management Signaling

DPMS	Screen	Power consumption	Hsync	Vsync
ON STATE	Display	120 W 92 W	Yes	Yes
STANDBY	No display	9 W 9 W	No	Yes
SUSPEND			Yes	No
OFF STATE			No	No

* In order from the top, the values are for the PN-B501 and PN-B401.

■Compatible signal timing (PC)

Screen resolution		Hsync	Vsync	Dot frequency	Digital		Analog (D-sub)
					HDMI	DisplayPort	
VESA	640 × 480	31.5kHz	60Hz	25.175MHz	Yes	Yes	Yes
		37.9kHz	72Hz	31.5MHz	Yes	Yes	Yes
		37.5kHz	75Hz	31.5MHz	Yes	Yes	Yes
	800 × 600	35.1kHz	56Hz	36.0MHz	-	-	Yes
		37.9kHz	60Hz	40.0MHz	Yes	Yes	Yes
		48.1kHz	72Hz	50.0MHz	Yes	Yes	Yes
		46.9kHz	75Hz	49.5MHz	Yes	Yes	Yes
	848 × 480	31.0kHz	60Hz	33.75MHz	-	-	Yes
	1024 × 768	48.4kHz	60Hz	65.0MHz	Yes	Yes	Yes
		56.5kHz	70Hz	75.0MHz	Yes	Yes	Yes
		60.0kHz	75Hz	78.75MHz	Yes	Yes	Yes
	1280 × 768	47.8kHz	60Hz	79.5MHz	-	Yes	Yes
		60.3kHz	75Hz	102.25MHz	-	Yes	Yes
	1280 × 800	49.7kHz	60Hz	83.5MHz	Yes	Yes	Yes
	1280 × 960	60.0kHz	60Hz	108.0MHz	Yes	Yes	Yes
	1280 × 1024	64.0kHz	60Hz	108.0MHz	Yes	Yes	Yes
		80.0kHz	75Hz	135.0MHz	Yes	Yes	Yes
	1360 × 768	47.7kHz	60Hz	85.5MHz	Yes	Yes	Yes
	1400 × 1050	65.3kHz	60Hz	121.75MHz	Yes	Yes	Yes
	1440 × 900	55.9kHz	60Hz	106.5MHz	Yes	Yes	Yes
1600 × 1200 ^{*1}	75.0kHz	60Hz	162.0MHz	Yes	Yes	Yes	
1680 × 1050	65.3kHz	60Hz	146.25MHz	Yes	Yes	Yes	
1920 × 1200 ^{*1*2}	74.0kHz	60Hz	154.0MHz	Yes	Yes	Yes	
Wide	3840 × 2160 ^{*1*2}	54.0kHz	24Hz	297.0MHz	Yes	Yes	-
		56.3kHz	25Hz	297.0MHz	Yes	Yes	-
		67.5kHz	30Hz	297.0MHz	Yes	Yes	-
	4096 × 2160 ^{*1*2}	54.0kHz	24Hz	297.0MHz	Yes	-	-
	1280 × 720	45.0kHz	60Hz	74.3MHz	Yes	Yes	Yes
1920 × 1080	67.5kHz	60Hz	148.5MHz	Yes	Yes	Yes	
US TEXT	720 × 400	31.5kHz	70Hz	28.3MHz	Yes	Yes	Yes

*1 Displays a reduced image, except in Dot by Dot. In Dot by Dot, the image will be cut down to panel size then displayed.

*2 Used when ENLARGE is ON. Using a single monitor for this setting causes image quality degradation. The image cannot be displayed on the sub screen.

- Depending on the connected computer, images may not be displayed properly even if the compatible signal described above is input.

Specifications

Compatible signal timing (AV)

Screen resolution	Frequency	HDMI	Component
1920 × 1080p	24Hz	Yes	-
	50Hz	Yes	Yes
	59.94Hz	Yes	Yes
	60Hz	Yes	Yes
1920 × 1080i	50Hz	Yes	Yes
	59.94Hz	Yes	Yes
	60Hz	Yes	Yes
1280 × 720p	50Hz	Yes	Yes
	59.94Hz	Yes	Yes
	60Hz	Yes	Yes
720 × 576p	50Hz	Yes	Yes
720 × 480p	59.94Hz	Yes	Yes
	60Hz	Yes	Yes
640 × 480p(VGA)	59.94Hz	Yes	-
	60Hz	Yes	-
720(1440) × 576i	50Hz	Yes	Yes
720(1440) × 480i	59.94Hz	Yes	Yes
	60Hz	Yes	Yes

HDMI input terminal pins (HDMI Connector)



No.	Function	No.	Function
1	TMDS data 2+	11	TMDS clock shield
2	TMDS data 2 shield	12	TMDS clock-
3	TMDS data 2-	13	CEC
4	TMDS data 1+	14	N.C.
5	TMDS data 1 shield	15	SCL
6	TMDS data 1-	16	SDA
7	TMDS data 0+	17	DDC/CEC GND
8	TMDS data 0 shield	18	+5V
9	TMDS data 0-	19	Hot-plug detection
10	TMDS clock+		

D-sub input terminal pins (Mini D-sub 15 pin)

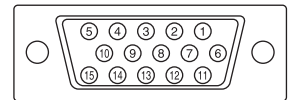

No.	Function	No.	Function
1	Red video signal input	9	+5V
2	Green video signal input	10	GND
3	Blue video signal input	11	N.C.
4	N.C.	12	DDC data
5	GND	13	Hsync signal input
6	GND for red video signal	14	Vsync signal input
7	GND for green video signal	15	DDC clock
8	GND for blue video signal		

RS-232C input terminal pins (D-sub 9 pin)

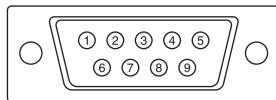

No.	Function	No.	Function
1	N.C.	6	N.C.
2	Transmitted data	7	N.C.
3	Received data	8	N.C.
4	N.C.	9	N.C.
5	GND		

DisplayPort input terminal pins (DisplayPort 20 pin)

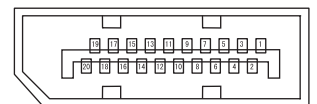

No.	Function	No.	Function
1	MainLane 3-	11	Gnd
2	Gnd	12	MainLane 0+
3	MainLane 3+	13	Gnd
4	MainLane 2-	14	Gnd
5	Gnd	15	Aux +
6	MainLane 2+	16	Gnd
7	MainLane 1-	17	Aux -
8	Gnd	18	Hot-plug detection
9	MainLane 1+	19	Gnd
10	MainLane 0-	20	3.3V

■RS-232C output terminal pins

(D-sub 9 pin)

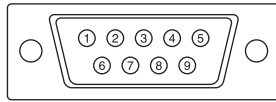

No.	Function	No.	Function
1	N.C.	6	N.C.
2	Received data	7	N.C.
3	Transmitted data	8	N.C.
4	N.C.	9	N.C.
5	GND		

■DisplayPort output terminal pins

(DisplayPort 20 pin)

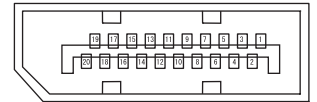

No.	Function	No.	Function
1	MainLane 0+	11	Gnd
2	Gnd	12	MainLane 3-
3	MainLane 0-	13	Gnd
4	MainLane 1+	14	Gnd
5	Gnd	15	Aux +
6	MainLane 1-	16	Gnd
7	MainLane 2+	17	Aux -
8	Gnd	18	Hot-plug detection
9	MainLane 2-	19	Gnd
10	MainLane 3+	20	3.3V

Mounting Precautions (For SHARP dealers and service engineers)

- When installing, removing or moving the monitor, ensure that this is carried out by at least 2 people.
- Be sure to use a wall-mount bracket designed or designated for mounting the monitor.
- This monitor is designed to be installed on a concrete wall or pillar. Reinforced work might be necessary for some materials such as plaster / thin plastic board / wood before starting installation.
- This monitor and bracket must be installed on a wall which can endure at least 4 times or more the weight of the monitor. Install by the most suitable method for the material and the structure.
- To attach a VESA-compliant mounting bracket, use M6 screws that are 5/16 inch (8 mm) to 3/8 inch (10 mm) longer than the thickness of the mounting bracket.

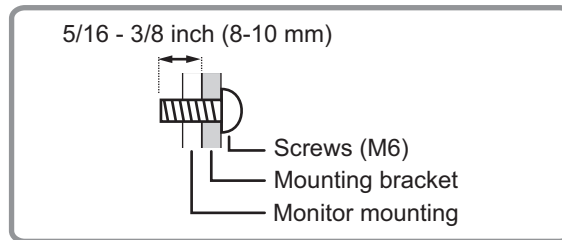

- Do not use an impact driver.
- When moving the monitor, be sure to hold the parts marked by  below. Do not hold the LCD panel. This may cause product damage, failure, or injury.

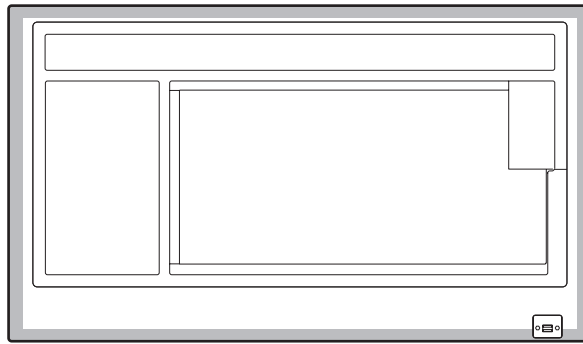

- After mounting, please carefully ensure the monitor is secure, and not able to come loose from the wall or mount.
- Do not use any screw holes other than VESA holes for installation.
- When using this monitor laying flat on a surface (when the monitor is tilted more than 20 degrees upward or downward from the perpendicular in relation to a level surface), consult an authorized SHARP dealer because there are some specific mounting conditions.

SHARP[®]
SHARP CORPORATION